

Short Term Load Forecasting Based Artificial Neural Network

Dr. Adel M. Dakhil
Department of Electrical Engineering
Misan University
Iraq- Misan
Dr.adelmana@gmail.com

Abstract Present study develops short term electric load forecasting using neural network; based on historical series of power demand the neural network chosen for this network is feed forward network, this neural network has five input variables (hour of the day, the day of the week, the load for the previous hour, the load of the pervious day, the load for the previous week). Short term load forecast is very important due to accurate for power system operation and analysis system security among other mandatory function.

The trained artificial neural network shows good accuracy and robust in forecasting future load demands for the daily operation, mean absolute percentage error (MAPE) was calculated and it is maximum value is 0.75% in load forecasting on Monday.

Index Terms — Actual load, Feed forward , Load forecasting, Neural Network, predicted load, Short term load forecasting.

I. INTRODUCTION

The load forecasting is highly related to power system operation such as dispatch scheduling, preventive maintenance plan for generators, and the reliability evaluation of the power system[1, 2]. Since the last decade of the last century the problem of electrical power in Iraq became the major challenge in this country due to the damage of the power system, increased of human social activities, industrial activities as well as community development level, conventional mathematical model defect to give proper estimation of load forecast, this problem lead to detect a method that has a proper evaluation of the present day and the future demand of power. Some of these methods which used to evaluate load forecasting are similar day approach, fuzzy logic, expert systems etc. among them, ANN methods are particularly attractive, as they have ability to handle the nonlinear relationships between load and the factors affecting it directly from historical data and without having to select a given model [3, 4,5], Considering the international trend on electric power load forecasting techniques, neural net and fuzzy theory are now actively utilized to reduce the uncertainty and the nonlinearity property which

are latent to problem of electric power load forecast[6, 7, 8,9 , 10].

Artificial neural network has been used in estimating the load forecasting in misan city where a historical data are used to train this neural network, the trained network used to estimate the future load.

The types of load forecast can be divided into three categories depend on load forecast time; the first one is short term forecasts which refer to hourly predications of a load for a lead time ranging from one hour to several days, the second one is the medium-term forecasts, this type is used to estimate hourly or peak load forecasts for a horizon of one to several months, the last categories are long term forecast which refer to forecasts made for one to several years in future, the character of long term load forecasting is to calculate and allocate the required future capacity, to plan for new power stations to face customer requirements; and last plays an essential role to determine future budget [11,12]. The medium term load forecasting specialty are fuel allocation and maintenance schedules, while the short term load forecasting advantages are accurate for power system operation, also used to analysis system security among other mandatory function.

For a particular region, it is possible to predicted the next day load with an accuracy of approximately 1-3 %, however it is impossible to predicted the next year peak load with similar accuracy since accurate long term weather forecasts are not available [13]. The quality of short-term hourly load forecasts has a significant impact on the economic operation of the electric utility since decisions such as economic scheduling of generation capacity, transaction such as Available Transmission Capacity (ATC) are based on these forecasts and they have significant economic consequences[14].

II. NETWORKS STRUCTURE AND TRAINING

Multilayer feed forward networks were chosen to process the prepared input data. For designing the neural network, different networks with 6 inputs and 1 output were considered. The numbers of neurons for the hidden layers of the network has finally chosen to be 21 neurons. For this network, tan-sigmoid function was used as the activation function of the hidden layer neurons. Saturated linear function was used for the output layer as shown in Fig(1).

Artificial neural networks ANN use a dense interconnection of computing nodes to approximate nonlinear functions each node constitutes a neuron and performs the multiplication of the input-signals by constant weight, sums up the results and maps the sum to a nonlinear activation function g , the result is then transferred to its input. A feed forward ANN is organized in layers an input layer, one or more hidden layers and one output layer. Node i , also called neuron, in Multi Layer Perceptron (MLP) network is shown in Fig(2). It is includes a summer and a nonlinear activation function g . The complex relationship between output and input can be evaluated using multi-layer perception MLP networks, due to this ANNs are used to obtain short term forecasting.

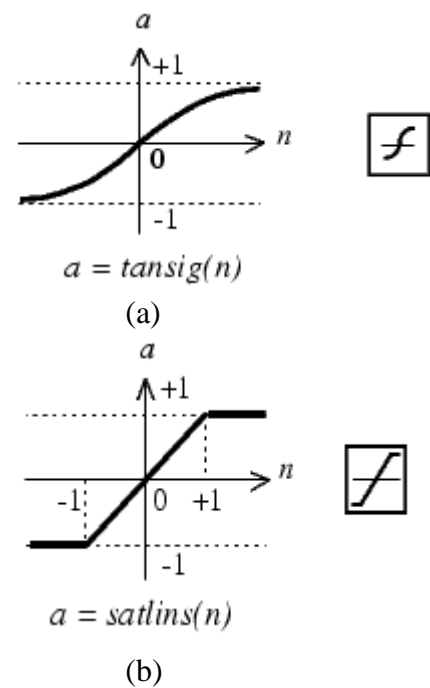

Fig. 1 Hidden and output function
(a) activation function of the hidden layer neurons
(b) Saturated linear function

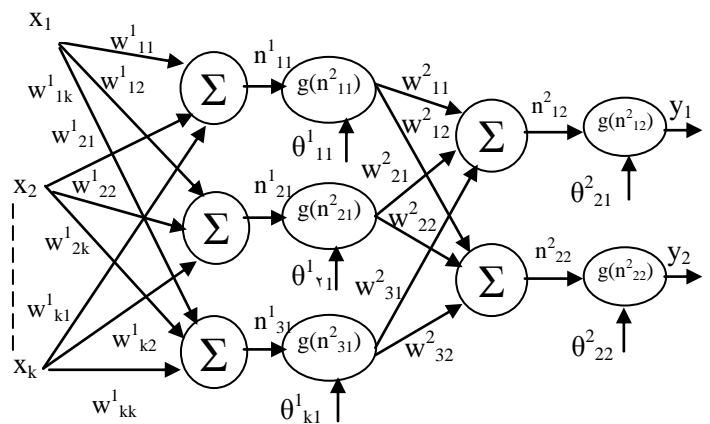

Fig.2 A multilayer perception network with one hidden layer

III. TRAINING OF ARTIFICIAL NEURAL NETWORK WITH INPUT DATA

The ANN is trained by a learning algorithm which perform the adaptation of weights of the network iteratively until the error between target vectors and the output of the ANN is less than an error goal. The most popular learning algorithm for multi layer networks is the back propagation

algorithm. Back-propagation is used as the training method, the training stops when the performance has been minimized to the goal. ANN were built by using Matlab Software Package with the following inputs (hour of the day, the day of the week, the load for the previous hour, the load of the pervious day, the load for the previous week), Fig.(3) shows the Matlab widows which used to built the ANN, the chosen number of the neurons in the hidden layer must satisfied the following two conditions; first one these neurons must not be less than a certain number which cause the network have a difficulty to learning. The other condition, be careful too many neurons make the estimator over specialized, leading to loss of generalizing capability.

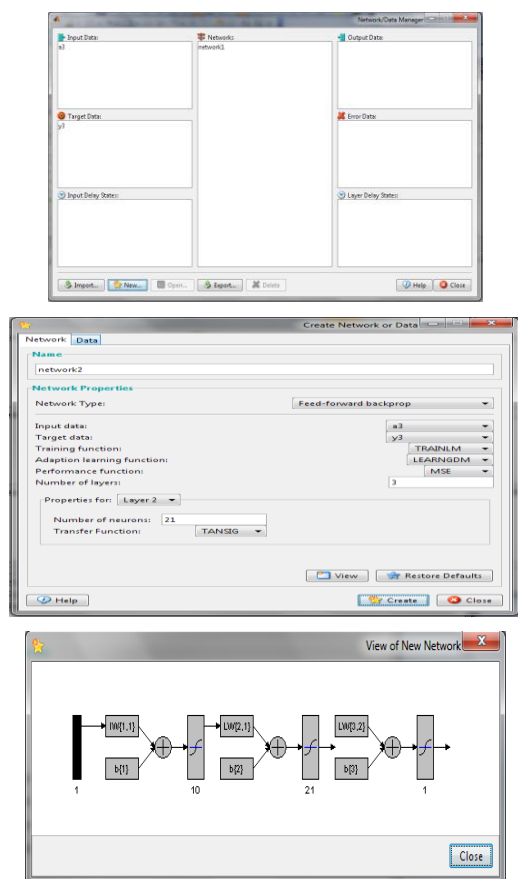

Fig.3 Matlab Window for the neural network

A back-propagation network with momentary and with adaptive learning rate was trained and the neural network can forecast future load one hour ahead given in various inputs to the network. A sigmoid transfer function was used in the hidden layer while a linear transfer function was used in

the output layer. at the beginning the data obtained from (Misan Electrical Distributed Directory) data are used to train the network, the hidden layer are chosen with 10 neurons, the training repeated with more neurons to have good characteristic which gave better estimation. The training continue until reach the number of epochs specified at the begin, the best characteristic obtain with a number of neurons equal to 21 neurons i.e. the error between target and output value be minimum.

The performance measures can be obtained by using mean absolute percentage error (MAPE) [15, 16].

$$MAPE(k) = n^{-1} \sum_{t=1}^k \left(\frac{P_{predicated}(t) - P_{actual}(t)}{P_{actual}(t)} \right) \quad (1)$$

In above equation, index k represent hour of the day and $P_{predicated}$, P_{actual} is predicted and actual power respectively, Fig.(4) shows the performance profile with 100 Epochs, the performance function is reduced to 0.0198784.

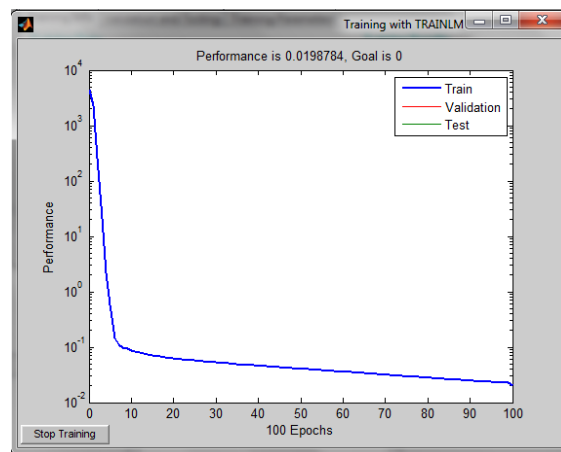

Fig.4 Performance profile with 100 Epochs

The mean absolute percentage error (MAPE) for Monday has been shown in Fig.(5) . The (MAPE) for the week days are shown in table (1). The highest (MAPE) values were recorded for Wednesday and Friday due to greater deviations about the minimum power point in addition to errors in the forecast for the peak demand periods.

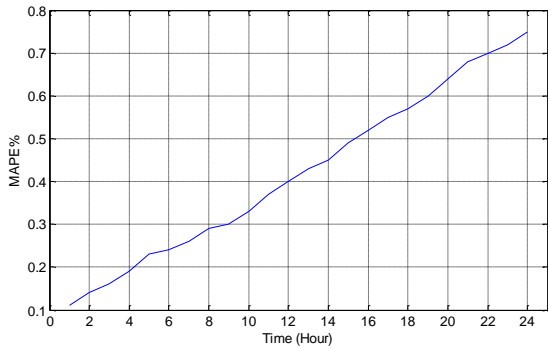

Fig.5 Monday mean absolute percentage error (MAPE)

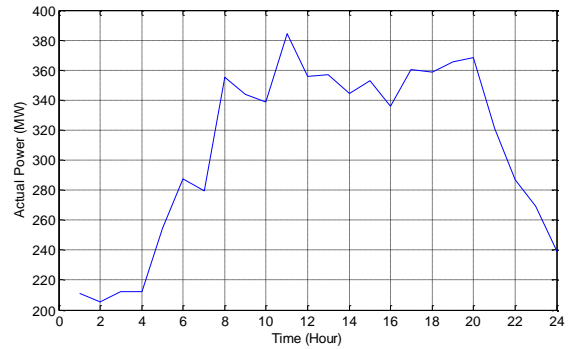

Fig.7 First Sunday load curve on May

Table (1) Mean absolute percentage error (MAPE) for the week days

Day of the week	(MAPE)
Friday	0.72
Saturday	0.67
Sunday	0.62
Monday	0.75
Tuesday	0.68
Wednesday	0.61
Thursday	0.68

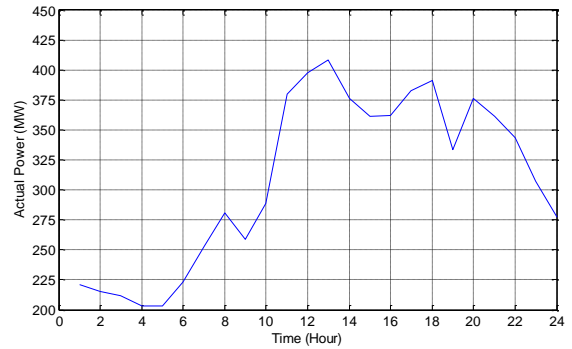

Fig.8 First Sunday load curve on June

IV. ANALYSIS FOR ELECTRIC POWER LOAD FORECASTING IN MISAN CITY

The load curves for misan governance for first Sunday on April, May, June as an example is depicted in Fig.(6), Fig.(7), and Fig.(8). The growth in these curves are obviously due to raising the temperature.

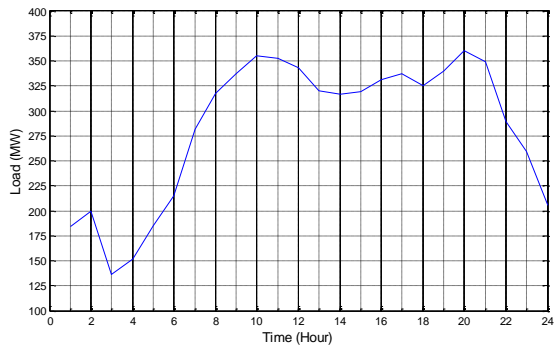

Fig.6 First Sunday load curve on April

The collected data utilized for training and testing the neural network.

The predicted load obtained from the trained neural network on new data over entire day over one week period are listed in the following figures, each graph shows a plot of both the actual and predicted load in (MW) values against the hour of the day. The load demand with respect to week day are shown in Fig(9) – Fig.(15) with respect to week days, the lowest one in week end.

from Fig.6 through Fig.8 the growth of demand power are clearly noticed also the variation of this power can be noted.

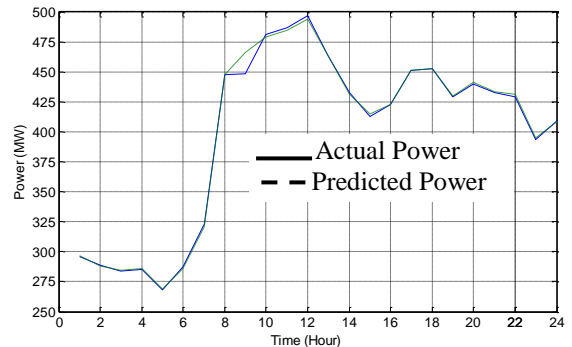

Fig.9 Actual and predicted Load profile for Friday 7/6/2013

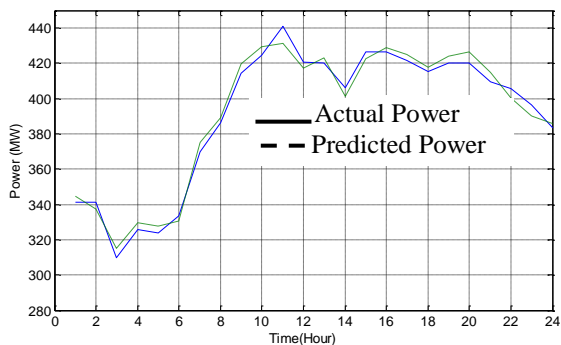

Fig.10 Actual and predicted Load profile for Saturday 8/6/2013

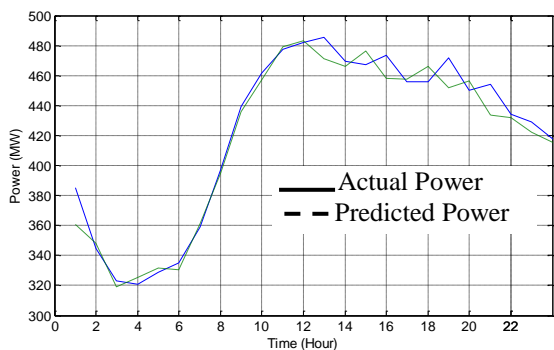

Fig.11 Actual and predicted Load profile for Sunday 9/6/2013

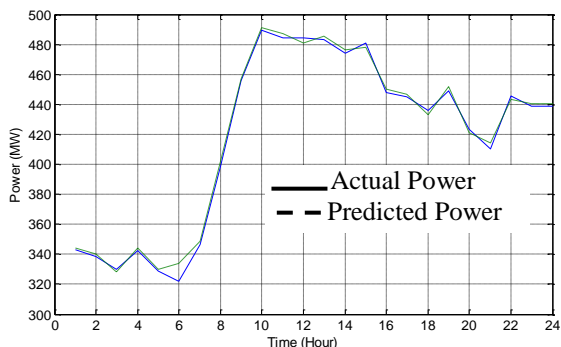

Fig.12 Actual and predicted Load profile for Monday 10/6/2013

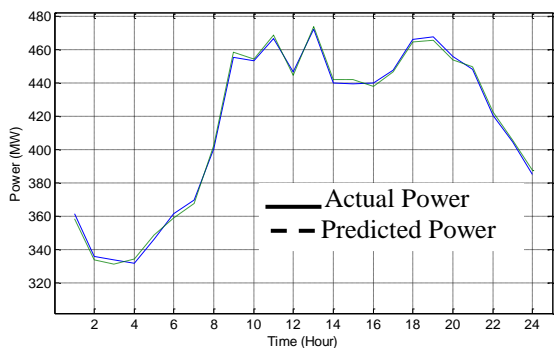

Fig.13 Actual and predicted Load profile for Tuesday 11/6/2013

From the above figures it is observed that the predicated error is almost acceptable and predicated power has a good agreement with the actual power.

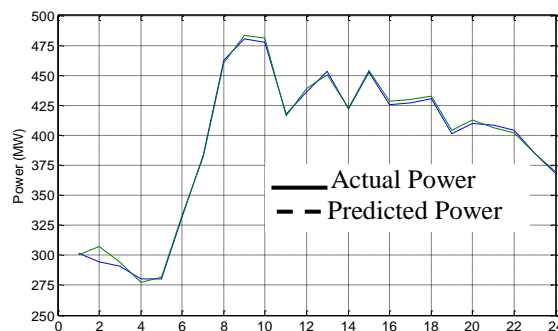

Fig.14 Actual and predicted Load profile for Wednesday 12/6/2013

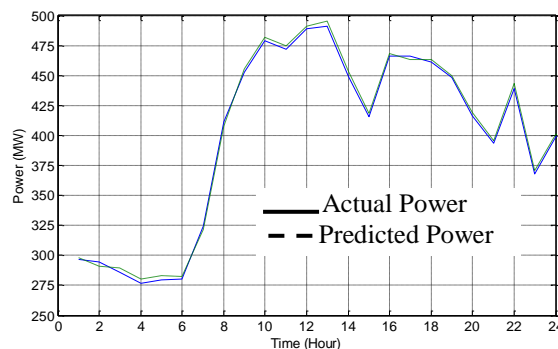

Fig.15 Actual and predicted Load profile for Thursday 13/6/2013

V. CONCLUSION

Controls of the performance predication represent the premise of a good global forecasting performance, in this paper MLP artificial neural network is used for load forecasting, ANN has three layer first one is the input layer, the hidden layer is the second one the third one is the output layer, some of the historical load demand data for misan city were used to train this ANN, the rest of this data are used testing.

The result of this network used for one hour ahead short term load forecast for misan city, shows that this network has a good performance and reasonable predication accuracy was achieved for this model.

ACKNOWLEDGMENT

The author would like to thank the staff Directory of Misan Electrical Distributed especially the manager, Boss Eng. Falah Hadi, responsible of planning Eng. Saad Abd Al-hussain, responsible of projects Eng. Muhammad Jasim Harfash, for the contribution of this work and providing data.

REFERENCES

- [1] K. Song ,Y. Baet, and D. Hong, " Short Term Load Forecasting for the Holidays Using Fuzzy Linear Regression Method", IEEE Transactions on Power Systems, Vol.20, No.1, p.p.96-101, February 2005,.
- [2] R. Swaroop, I. Hussein, and A. Abdulgader," Load Forecasting for Power System Planning Using Fuzzy-Neural Networks", Proceeding of the world congress on engineering and computer science 2012, Vol.I, WCECS2012, san Francisco USA, p.p.187-191, October 2012.
- [3] C. Lu, H.Wu, and S. Vemuri," Neural Network Based Short Term Load Forecasting", IEEE transaction on power systems, Vol.8, No.1, p.p.337-342, February 1993.
- [4] J. Taylor, and R. Buizza," Neural Network Load Forecasting with Weather Ensemble Predictions", IEEE Transaction on power systems, Vol.17, No.3, p.p.626-632, Aug 2002.
- [5] P. Mandal, T. Senjyu, and N. Urasaki," A Neural Network Based Several Hour Ahead Electric load Forecasting Using Similar Day Approach" , International Journal of Electric Power and Energy System, Vol.28, No.6, p.p.367-373, July 2006.
- [6] S. Rahman and B. Bhatnagar," An Expert System Based Algorithm for Short Term Load Forecast" IEEE Transactions on Power System, Vol. p.p.50-55,1987.
- [7] T. Peng, " An Adaptive Neural Network Approach to One Week Ahead Forecasting", IEEE Transaction on Power Systems, Vol.8, p.p.1195-1203, August 1993.
- [8] A. Bakirtzis," A Neural Network Short Term Load Forecasting Model for the Greek Power System", IEEE transactions on Power Systems, Vol.11, p.p.858-863, May 1996.
- [9] R. Lamedica, " A Neural Network Based Technique for Short Term Forecasting of Anomalous Load Periods", IEEE transactions on Power Systems, Vol.11, p.p.1749-1756, November 1996.
- [10] D. Chaturvedi , S. Anad, and A. Chandiok," Short Term load Forecasting Using Nero- Fuzzy-Wavelet Approach", International Journal of Computing Academic Research, Vol.2, No.1, p.p.36-48, February 2013.
- [11] Y. Aslan, S. Yavasca, and C. Yasar," long Term Electric Peak Load Forecasting of Kutahaya Using Different Approches", International Journal on Technical and Physical Problems of Engineering, Issue 7, Vol.3 No.2, p.p.87-91, June 2011.
- [12] O. Dragomir, R. Gouriveau," Medium Term Load Forecasting Using ANFIS Predictor", 18th Mediterranean Confrence on Control and Automation, p.p.235-240, 2010.
- [13] S. Sheikh and M. Unde," Short Term Load Forecasting Using ANN Technique", International Journal of Engineering Sciences and Emerging Technologies, Vol. 1, Issue 2, p.p.97-107, February 2012.
- [14] M. Buhari and S. Adamu," Short Term Load Forecasting Using Artificial Neural Network", Proceeding of the International Multi Conference of Engineering and Computer Scientists, Vol.1, p.p.221-226, March 2012.
- [15] C. Guan, P. Luh, and D. Michel, " Very Short Term Load Forecasting: Wavelet Neural Networks With Data Pre-Filtering", IEEE Transactions on Power Systems, Vol.28, No.1, p.p.30-41, February 2013.
- [16] Y. Chen, P. Luh, and D. Michel," Short Term Load Forecasting : Similar Day- Based Wavelet Neural Networks", IEEE Transactions on Power Systems, Vol.25, No.1, p.p.322-330, February 2010.