

Behavior of Experimental Model of Piled Raft Foundations on Clayey Soils

Dr. Mahmoud AL-Qaissy

Building and Construction Engineering Department, University of Technology/ Baghdad

Dr. Hussein H. Karim

Building and Construction Engineering Department, University of Technology/ Baghdad

Email: hussn_irq@yahoo.com

Mudhafar K. Hameedi

Building and Construction Engineering Department, University of Technology/ Baghdad

ABSTRACT

Piled raft foundations are a geotechnical composite construction consisting of three elements: piles, raft and soil. In the design of piled rafts, the load is assumed to be shared between the piles and the raft. Therefore, this may improve the ultimate load capacity and reduce settlements in a very economic way as compared with the traditional foundation concepts. Due to the development of structures that use piled rafts as a foundation system, an extensive experimental study was performed by two different scale models with the same L/D_p (Embedment length to pile diameter ratio) and L/B_r (Embedded length to raft width ratio B_r) to achieve the scale effect and plane stress condition for the large scale model and plane strain condition for the small scale model. The load carrying capacity of the piles and raft have been studied and presented as load-settlement illustrations. From a comparison between the two models of the experimental work, it is found that the effect of scale cause an increase in carrying load of piled raft with increasing the number of piles. It was found that the percentage of the load carried by raft to the total applied load of the experimental model in the case of four piles with raft is ranged between 60.6 - 64.8 %.

Keywords: Piled Raft Foundations; Piled Raft Geometry; Load Carrying Capacity; Settlement; Clayey Soils

سلوك النموذج المختبري للأسس الحصيرية المقامة على التربة الطينية

الخلاصة ان الأسس الحصيرية المدعمة بالركائز هي منشآت جيوتكنيكية مركبة يتألف من ثلاث عناصر هي: الركائز والحصيرة والتربة. في الأساس الحصيري المدعم بالركائز، يتوزع الحمل بين الركائز

والاساس الحصييري. هذا النوع من الاسس فعال في زياده التحمل و تقليل الهطول وذو تكلفة اقل من أسس مجاميع الركائز. ونظراً لزيادة المنشآت التي يستخدم معها الأساس الحصييري المدعم بالركائز، لقد اجريت دراسة عملية مكثفة تضمنت استخدام نموذجين مختلفين في المقياس وذو نسب (L/Dp) او (L/Br) متساوية لدراسة تأثير مقياس النموذج ولتحقيق اجراء الفحوصات عن طريق تسليط الأجهاد وتسلط الأنفعال. وتم دراسة تأثير المقياس على مقدار قابلية التحمل في الاساس المدعم بالركائز وتم توضيحها في مخطط العلاقة بين الحمل - الهطول. من مقارنة النموذجين المختبريين، وجد ان تأثير المقياس في قابلية التحمل يزداد بزيادة عدد الركائز المستخدمة في الاساس الحصييري المدعم بالركائز. وجد ان النسبة المئوية لقابلية تحمل الأساس الحصييري الى الحمل الكلي للنموذج العملي في حالة أربعة ركائز مع الأساس تتراوح ما بين 60.6 الى 64.85 %.

INTRODUCTION

A piled raft foundation is a new concept in which the total load coming from the superstructure is partly carried by the raft through contact with soil and the remaining load is carried by piles through skin friction and base bearing. Such piled raft foundations on thick clay deposit have been found successful in places like coastal belt of Frankfurt, London, etc [1]. In conventional piled foundation it is assumed that the raft does not carry any load even if raft is in contact with ground.

Also in conventional piled foundations, as the contribution of raft is ignored, long piles are provided which extends up to the deep strata. On the other hand, if only raft has to carry the total load coming from the superstructure, very thick raft is needed which increase the cost of the foundation [2]. Such raft foundation undergoes excessive settlement. So in such condition the piled raft foundation can be considered the best solution in which shorter piles and raft of lesser thickness can be provided [3].

According to Katzenbach et al. (1998) [4], the loading transmitted to the soil by the raft can have a beneficial effect on the pile behavior in the piled raft system. The pile foundations are normally used when constructing a heavy building on a low bearing soil. Mandolini and Viggiani (1997) [5] presented an analysis to predict the settlement of piled raft foundations. A complete three-dimensional analysis of a piled raft foundation system was carried out by the finite element method [4].

Wiesner and Brown (1980) [6] studied four model of piled raft foundations in a large pot with an internal diameter of (590) mm and a depth of (480) mm filled with over consolidated clay.

The main objective of this article is to study experimentally the load sharing mechanism between the raft and piles, as well as the load settlement behavior of the piled raft with different configurations.

EXPERIMENTAL WORK

The main purpose of the experimental approach implemented in this study is to study the load sharing mechanism between the raft and piles, as well as the load settlement behavior of the piled raft foundation with different configurations. The load

tests are programmed to be incorporated in test of two models. These tests are carried out on single pile, raft, pile group and piled raft.

Models of the Experimental Work

Two different scale models are used: large scale model to achieve plane stress condition and small scale model to achieve plain strain condition.

Set-up of the Large Scale Model

The apparatus consists of compression machine (steel frame with a hydraulic jack) steel container, loading frame, dial gauges, proving ring and accessories:

Large scale model is carried out in a steel frame tank with dimensions of 75 ×75 cm and 50 cm depth, bounded by Steel plate is 6 mm in thickness as shown in Figure (1). The container is sufficiently rigid and exhibited no lateral deformation during the preparation of the soil bed and during the application of loads. The internal sides of the tank are lining with polyethylene sheets in order to keep the water content of soil unchanged.

Figure (2) shows details of the complete set-up which consists mainly of steel container, loading frame, dial gauges, proving ring and accessories. The vertical load is applied on the raft and piles models by hydraulic jack of 10 ton capacity. The applied load is measured by proving rings (Wykeham Farrance, England) of 3 kN and 10 kN capacity with 0.01 mm/division accuracy. Two dial gauges of sensitivity 0.01 mm is used to measure the displacements at the centre line of the piled raft model.

Set-up of the Small Scale Model:

The set-up of the small scale model consists of loading machine, steel container with plastic sides which is manufactured by the researcher , loading frame with electric motor, digital indicator gauges, loading cell, monitor and accessories, as follows:

Plastic rigid container:

The tests of the experimental small model are carried out in a container of steel frame with dimensions of 24 cm × 24cm and 24 cm depth, the plastic side of the container is 6 mm in thickness as shown in Plate (1). The container is sufficiently rigid and exhibited no lateral deformation during the preparation of the soil bed and during the test.

Loading Machine:

Plate (2) shows the details of the complete set-up which consists mainly of plastic sided rigid container, loading frame with electrical motor, digital indicator gauges, load cell, monitor and accessories.

The vertical load is applied on the model of piles, raft and piled raft by a compression machine of 10 kN capacity. The applied load measured using a load cell of 50 kN capacity. A digital indicator gauge is used for measuring the displacements at the centre line of the piled raft model, as shown Plate 3. The test results are saved by a digital monitor, as shown in Plate (4).

MODELS OF THE PILED RAFT

The pile models used in large scale model test is concrete rounded pile of 40cm length and 2.5cm diameter. The embedment length ratio $L/D_p = 16$, the spacing(s) between piles is kept constant about 3 times the diameter of the pile ($3D_p$). The model of raft used is a square steel plate of 15×15 cm and 1.2 cm thickness, to a chive L/B_r ratio of (2.66), where B_r is the width of the raft and L is the embedment pile length.

For small scale model, the length of concrete model piles is 16 cm and 1cm diameter. The model of raft used is a square steel plate of 6×6 cm and 0.6 cm thickness the same L/B_r ratio of (2.66) and L/D_p of (16), the spacing(s) between piles is kept constant 3 times the diameter of the pile ($3D_p$). Table (1) shows the properties of material parameters for the raft and piles. The concrete pile models casting with a mix ratio 1: 2: 2, the gravel gradation was (2 - 3.15) mm, w/c of 4 % and with additive type SP90 of 0.4%.

THE SOIL USED

The soil samples were obtained from a depth of 0.5 m below the soil surface near of Al-Musaib Technical Institute in Babylon Governorate. It is subjected to routine laboratory tests to determine its properties. These tests include:

- 1- Grain size distribution (sieve analysis and hydrometer tests) according to ASTM D422 specifications. The grain size distribution of the soil is shown in Figure 3. According to the Unified Soil Classification System (USCS), the soil is inorganic sandy clay silty clay designated as CL.
- 2- Atterberg limits (liquid and plastic limits) according to ASTM D 4318 specifications. Table (2) shows the physical properties of the soil used.
- 3- Dry unit weight: The test is carried out by Standard Proctor Test according to ASTM D698.
- 4 - Shear strength test: The unconfined compressive strength test is performed according to ASTM D 2166.

PREPARATION OF THE SOIL AND TESTING

Preparation of the Soil Bed

Prior to the preparation of the soil bed, and to determine the shear strength of the soil used, a relationship was obtained between different percents of water content and shear strength Figure (4). The unconfined compression strength test is performed to find specify undrained shear strength (C_u) of the soil at optimum moisture content (18%) which gives C_u of 25 kPa. Then, the soil bed is prepared for both models.

Setup of the Tested Models

At the end of curing period(48 hrs), the top of the soil bed is leveled. The pile model is driven by a hammer of 4 kg weight to a depth of 40 cm for large scale model to get L/D_p ratio of 16. For small scale model a hammer of 2 kg used to driven the model of pile to a depth 16 cm to get the same of L/D_p ratio. Undrained shear strength and water

Content is measured directly at a depth near the top, at the middle and at the bottom of each soil bed by portable vane shear.

The tests were carried out on the following models for the two different model scales

- a- Raft only rested on clay.
- b- Single pile only embedded to the required depth
- c- Raft with single pile
 - The raft rested on clay.
 - The raft doesn't contact with soil.
- d- Raft with two piles .
 - The raft rested on clay.
 - The raft doesn't contact with soil.
- e- Raft with three piles (triangular pattern).
 - The raft rested on clay.
 - The raft doesn't contact with soil.
- d- Raft with four piles.
 - The raft rested on clay.
 - The raft doesn't contact with soil.

TESTING PROCEDURE FOR BOTH MODELS

The test was carried out according to the experimental program as follows:

- 1- Proving ring with accuracy of 0.01 mm/division is set such that the total load applied on the model of raft, and pile cap is measured.
- 2- Two dial gauges with accuracy of 0.01 mm/division are fixed in position on the raft or pile to measure the settlements.
- 3- During each load increment, for large scale model the readings of the two dial gauges corresponding to the proving rings are recorded.
- 4- For the small scale model the test is performed using control strain 0.5 mm/min for the loading machine.
- 5- The load increments are continued until the total settlement exceeds about 10 % of model footing width as shown in Plates 7 and 8.

FAILURE CRITERION

Several criteria have been proposed to define the failure load of the piles. Some of these criteria are described by Fellenius (2006) [7]. One of these criterion is Terzaghi proposal (1947) [8], in which failure was defined as the load corresponding to displacement of 10% of the model footing width or (pile diameter), this criterion is used for both experimental models .

RESULTS AND DISCUSSIONS

The models of the experimental work with different configuration of piles are shown in Figure (5).

Load Carrying Capacity

The settlement versus vertical load is plotted for both models. Figures (6 to 12) show the load-settlement behavior of piled rafts, group piles, single pile and raft for the large model.

Comparison among these figures, the shape of load-settlement is local shear failures which are controlled. From the behavior of the load-settlement relation of the piles in the present work, it is found that the tangent proposal can be adopted in specifying the ultimate piled raft capacity. The carrying capacity of the pile groups with different number, constant length, and diameter are shown in Table (3). In addition, the total carrying capacity of the piles relative to the total applied load increases with the increasing number of piles in the group, whereas the pile group of (four piles) recorded a maximum value of carrying capacity with 26.8% of the total applied load.

Figures (13 to 19) show the load- settlement behavior of piled rafts, group piles, single pile and raft of the small model. The shape of load-settlement of these figures indicates local shear failures which are controlled also. It is found that the tangent proposal can be adopted in specifying the ultimate piled raft capacity. The carrying capacity for the studied of the pile groups with different pile number, constant length and diameter are shown in Table (4). In addition, the total carrying capacity of the piles relative to the total applied load also increases with increasing the number of piles in the group, whereas the pile group of 2x2 recorded a maximum value of carrying capacity with 59.59 % of the total applied load.

Scale Effect

The effect of scale is studied through testing a certain piled raft configuration with constants L/D_p , and L/B_r . The percentage of the load carrying capacity of the piles for the two experimental models is shown in the Figure (20). The results show that the same percent of the carrying loading capacity for single pile as in the case of single pile with raft for both two models but it differentiates with increasing number of piles with raft.

CONCLUSIONS

The experimental modeling yielded the following conclusions:

1. For the piled raft models, the total carrying capacity of the model increased with increasing raft size and the number of piles in the group.
2. The percentage of the load carried by raft to the total applied load of the large model groups (single pile with raft, two piles with raft, three piles with raft, and four piles with raft) are 87.2%, 74% , 73.2% , 73.1% , respectively.
3. The percentage of the load carried by raft to the total applied load of the small model groups (single pile with raft , two pile with raft, three pile with raft, and four pile with raft) are 86.4%, 63.9% , 53.1% , 40.4% , respectively.
4. From comparison between the two models of the experimental work, it is found that the effect of scale on carrying load of piled raft increasing with increasing the number of piles.

REFERENCES

[1]. Maharaj, D.K., , “Load-Settlement Behavior of Piled Raft Foundation by Three-Dimensional Nonlinear Finite Element Analysis”, Electronic Journal of Geotechnical Engineering, Vol. 8, Bundle (C), pp.1-14, 2003.

[2]. Franke, E., “Measurements beneath Piled Rafts”, Keynote lecture, 1991.

[3]. Yamashita, K., Kakurai, M. and Yamada, T., “Investigation of a Piled Raft Foundation on Stiff Clay”, XIII International Conference on Soil Mechanics and Foundation Engineering, New Delhi, India, pp. 543-546, 1994.

[4]. Katzenbach, R., Arslan, U., Moormann, C., and Reul, O., “Piled Raft Foundation -Interaction between Piles and Raft” Proc., Int. Conf. on Soil- Structure Interaction in Urban Civil Engineering, Darmstadt Geotechnics, 2, pp. 279-296, Darmstadt University of Technology, Darmstadt, Germany, 1998.

[5]. Mandolini A. and Viggiani C., “Settlement of Piled Foundations” Geotechnique, Vol. 47, pp.791-816, 1997.

[6]. Wiesner, T.J., and Brown, P.T., “Laboratory Tests on Model Piled Raft Foundations”, Journal of Geotechnical Engineering Division, ASCE, Vol.106, No.GT7, pp.767-783, 1980.

[7]. Fellenius, B. H., “Basics of Foundation Design”, Book Electronic Edition, 2006, www.Fellenius.net , 346P. , March 2009,

[8]. Terzaghi, K., “Theoretical Soil Mechanics”, John Wily & Sons, NewYork. 1943.

Table (1) Properties the pile and raft.

•	Raft (Steel plate)	
§	Modulus of Elasticity	2*10⁸ (kPa)
§	Poisson's ratio	0.43
•	Pile (Concrete pile)	
§	Elasticity	2.9*10⁶ (kPa)
§	Poisson's ratio	0.15

Table (2) Physical properties of the used soil.

Property	Value
Liquid limit (LL), %	42
Plastic limit (PL), %	21
Plasticity index (PI) , %	21
Specific gravity (G _s)	2.71
% Passing sieve No. 200	90
Sand content, %	10
Silt content, %	42
Clay content < 0.005 mm, %	48
Maximum dry unit weight (kN/m ³)	18.6
Optimum water content, %	18

Table (3) Pile raft and pile group capacity of the first experimental model (Large scale model).

The Test	Axial Piled Raft Capacity (kN)	Axial Pile Capacity only (kN)	Axial Raft Capacity only (kN)	% of Load Carried by Piles	% of Load Carried by Raft
Single pile	-----	0.27	-----	100	0.0
Raft (15 cm ×15 cm)	-----	-----	2.03	0.0	100
Raft with single pile	2.12	0.27	2.03	4.2	87.2
Raft with two piles (2×1)	2.73	0.71	2.03	26.6	74.0
Raft with three piles	2.8	0.75	2.03	27.5	73.2
Raft with four piles (2×2)	3.13	0.84	2.03	35.1	73.1

Table (4) Piled raft and pile group capacity of the second experimental Model (Small scale model).

The Test	Piled Raft Capacity (kN)	Piles Capacity (kN)	Raft Capacity (kN)	% of Load Carried by Piles	% of Load Carried by Raft
Single pile	----	0.10	-----	100	0.0
Raft (6×6cm)	----	----	0.6	0.0	100
Raft with single pile	0.74	0.10	0.6	18.9	86.4
Raft with two piles (2×1)	0.86	0.31	0.6	30.2	63.9
Raft with three piles	0.96	0.45	0.6	37.5	53.1
Raft with four piles (2×2)	0.99	0.59	0.6	39.3	40.4

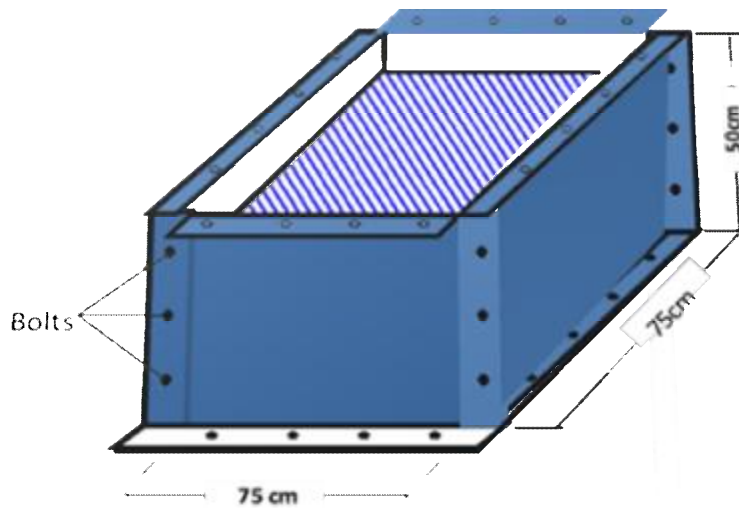

Figure (1) A Schematic diagram of steel container.

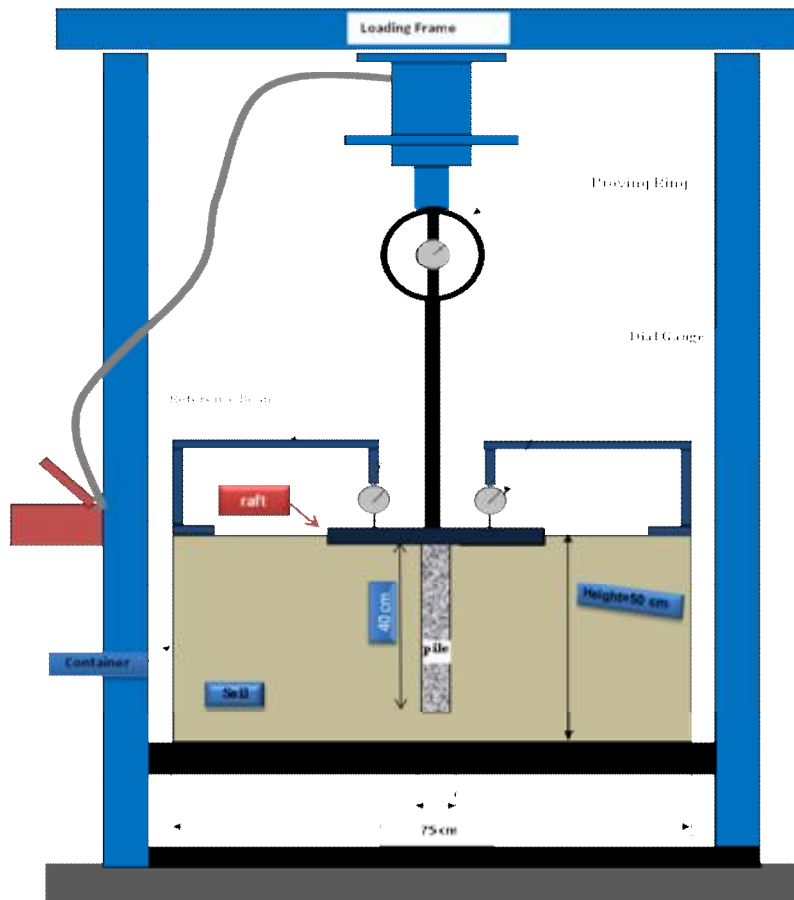

Figure (2) Schematic diagram of the experimental large Scale model set- up.

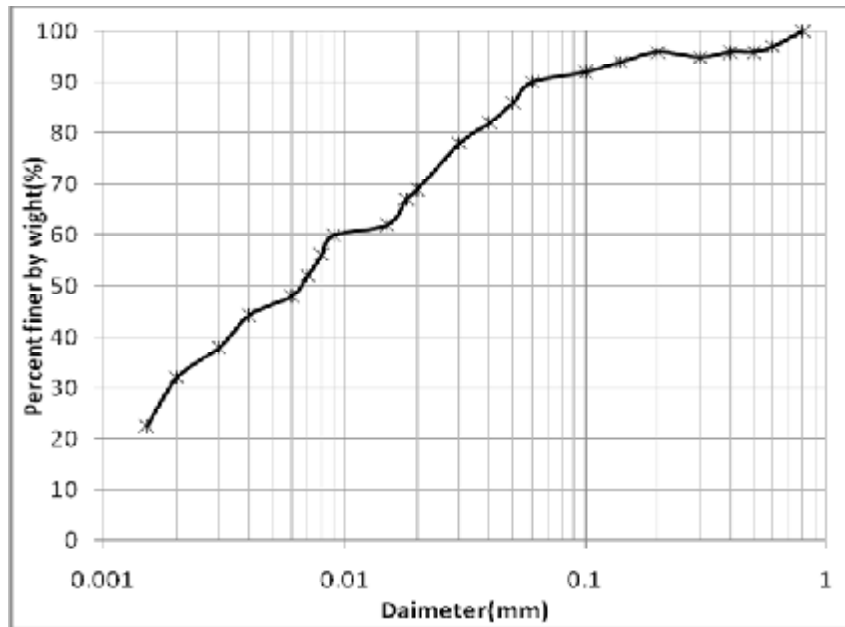

Figure (3) Grain size distribution.

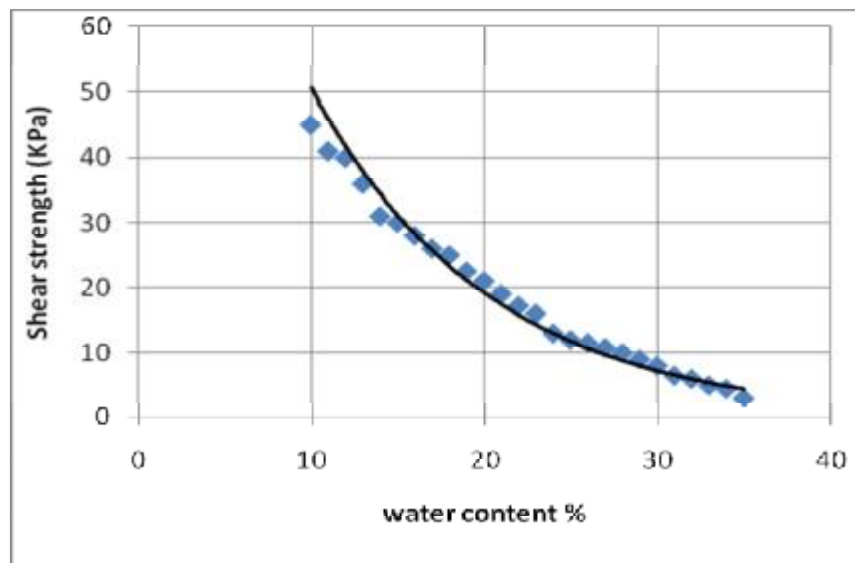

Figure (4) Relationship between water contact and shear strength.

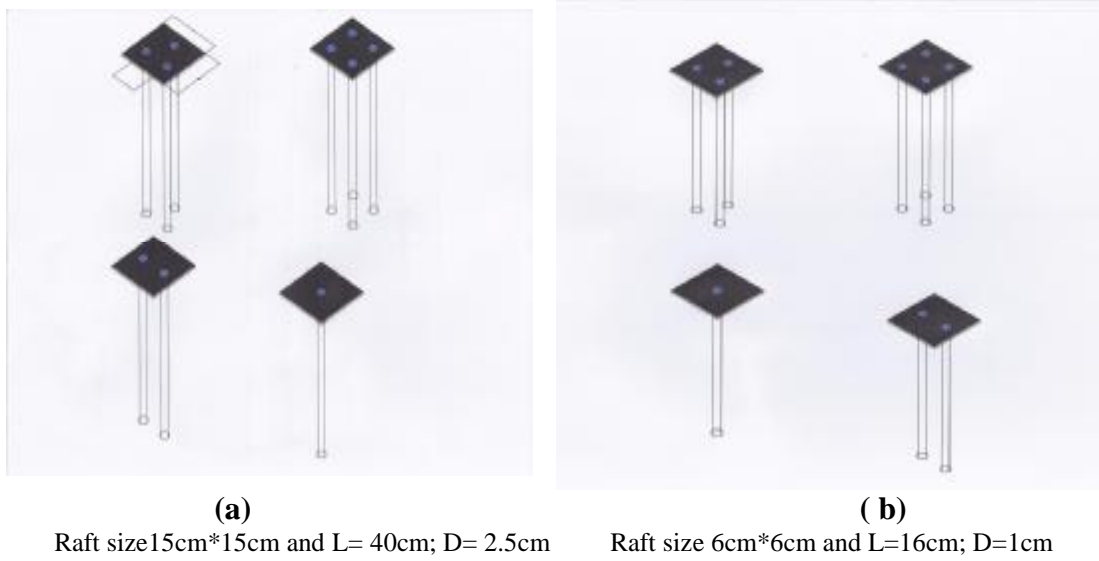

Figure (5) Pile raft models for experimental work.

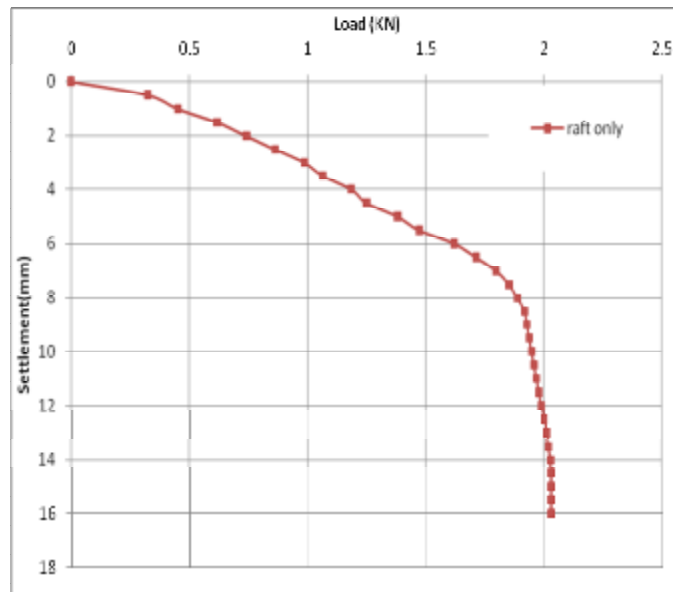

Figure (6) Load –displacement curve for raft size 15cm×15cm of the large model.

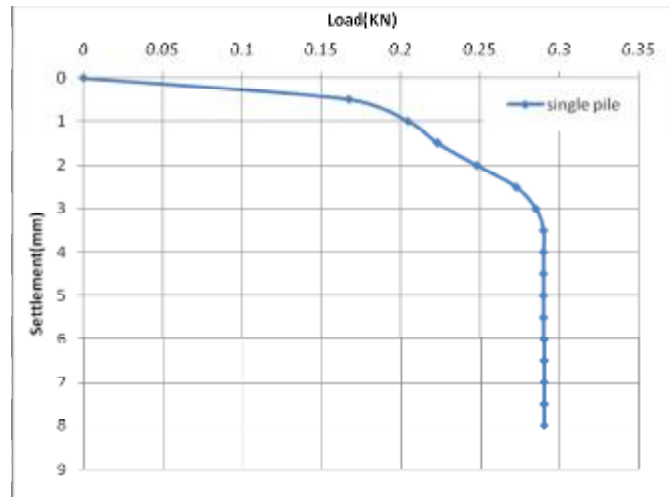

Figure (7) Load–displacement curve for single pile (L=40cm and D=2.5 cm) of the large model.

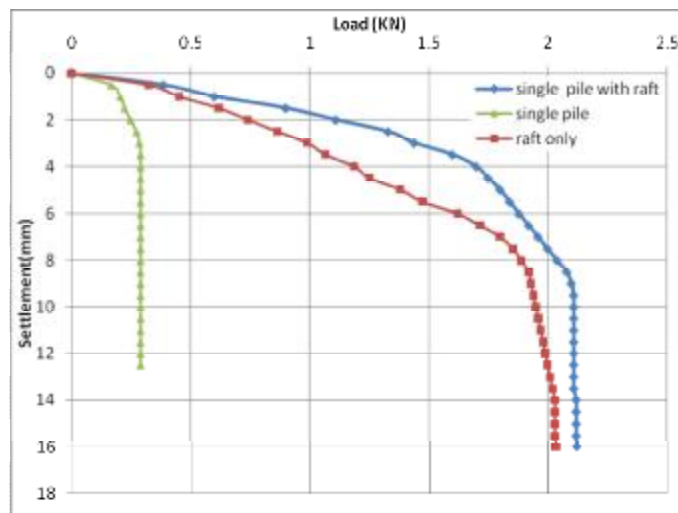

Figure (8) Load–displacement curve single pile with raft, single pile and raft only of the large model.

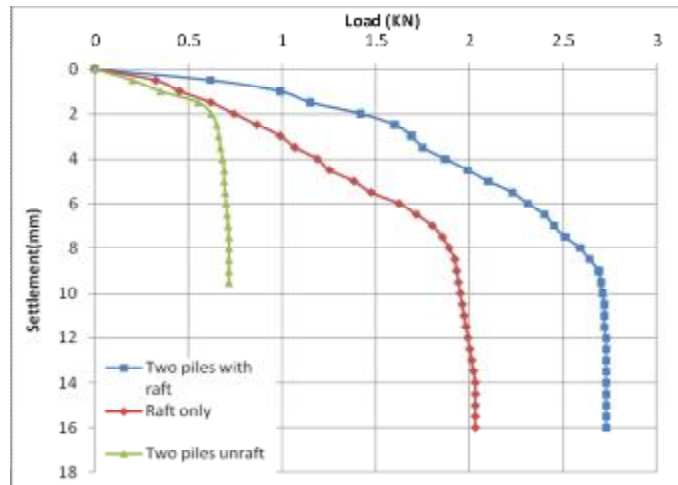

Figure (9) Load–displacement curve for two piles with raft, two piles unraft (The raft doesn't contact with soil) and raft only of the large model.

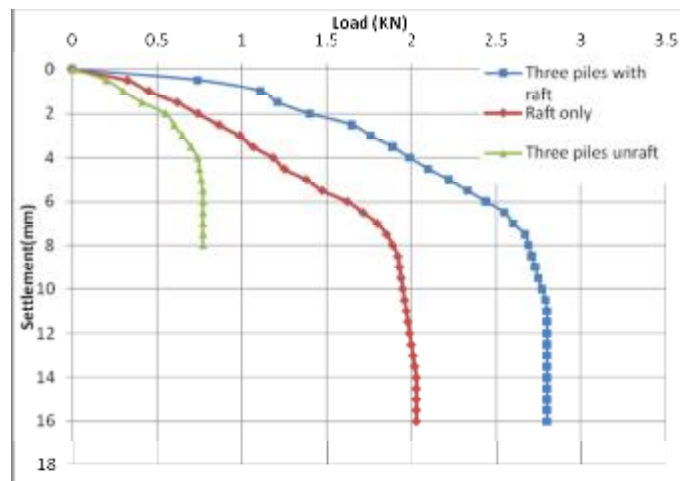

Figure (10) Load–displacement curve for three piles with raft, three piles unraft and raft only of the large model.

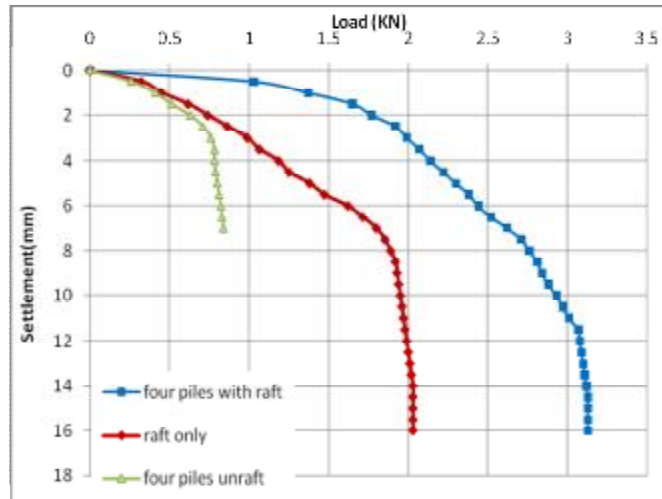

Figure (11) Load–displacement curve for four piles with raft, four piles unraft and raft only of the large model.

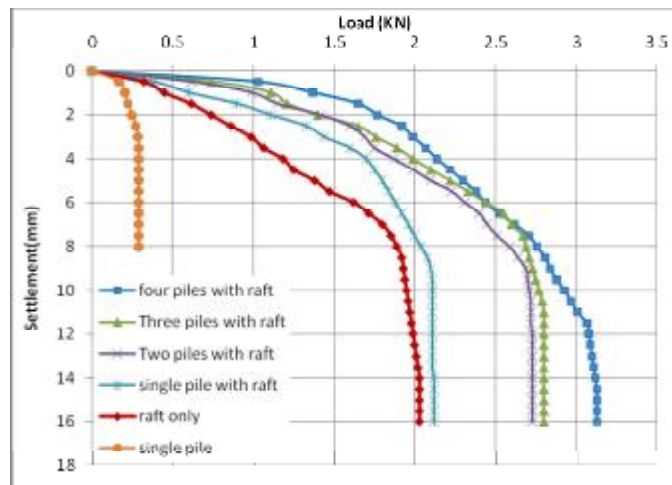

Figure (12) Load–displacement curve for all cases for of the large model.

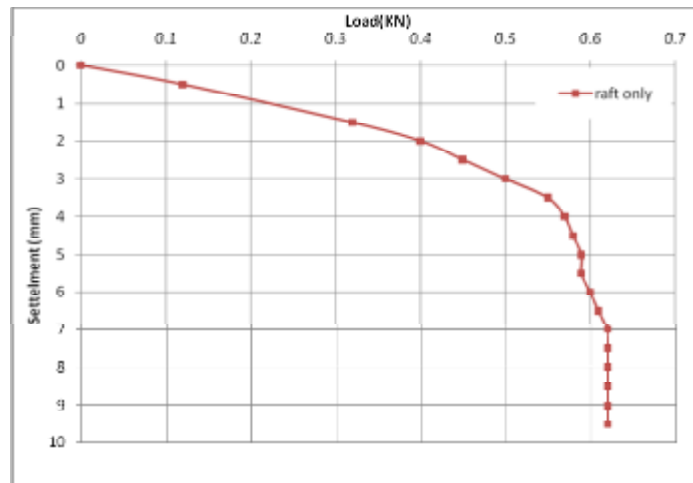

Figure (13) Load–displacement curve for raft size 6 cm × 6 cm of the small model.

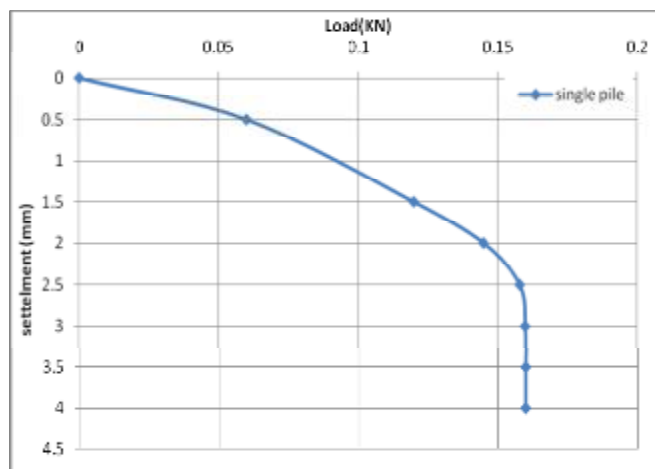

Figure (14) Load–displacement curve for single pile (L=16 cm and $D_p=1$ cm) of the small model.

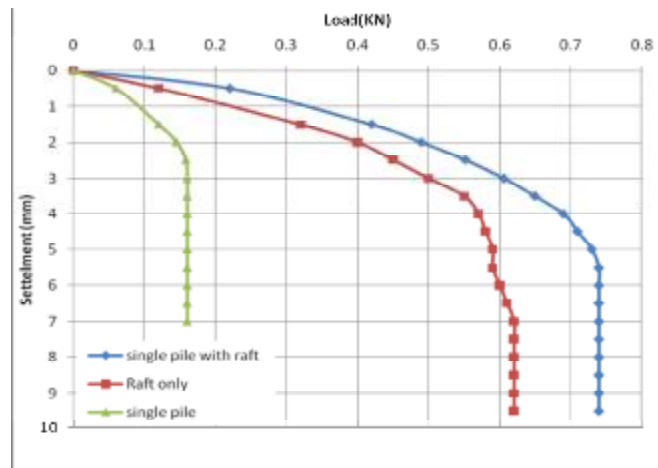

Figure (15) Load–displacement curve for single pile with raft, single pile and raft only of the small model.

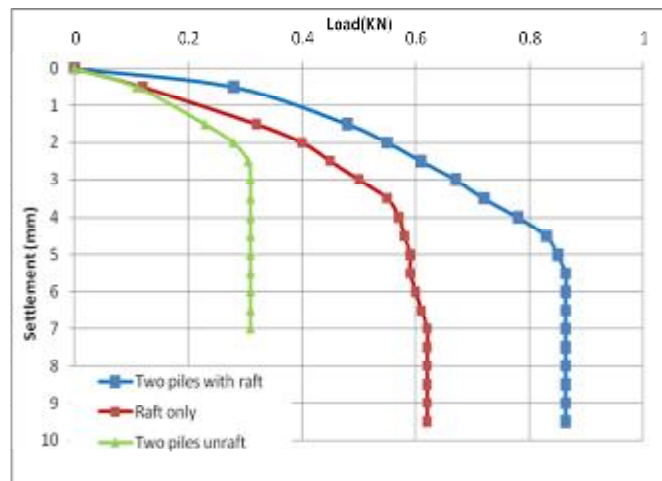

Figure (16) Load–displacement curve for two piles with raft, two piles unraft and raft only of small model.

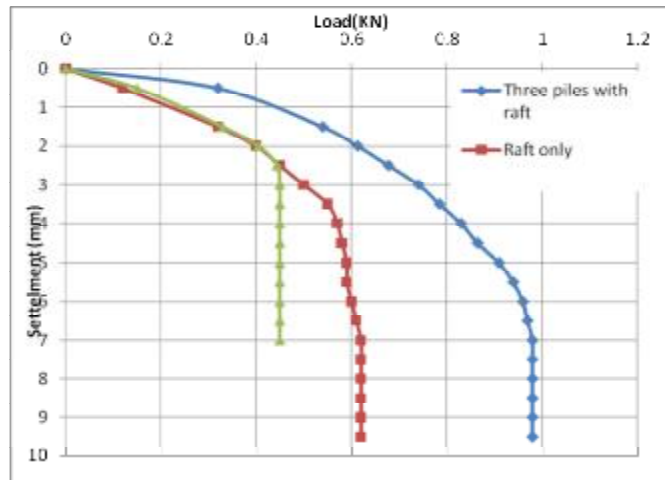

Figure (17) Load–displacement curve for three piles with raft, three piles unraft and raft only of the small model.

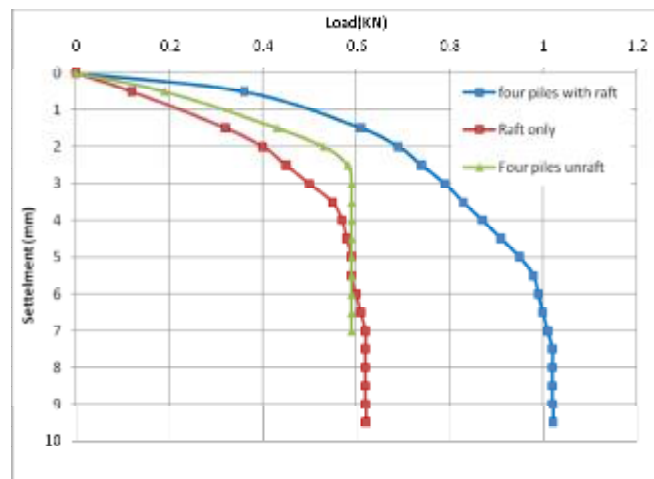

Figure (18) Load–displacement curve for four piles with raft, four pile unraft and raft only of the small model.

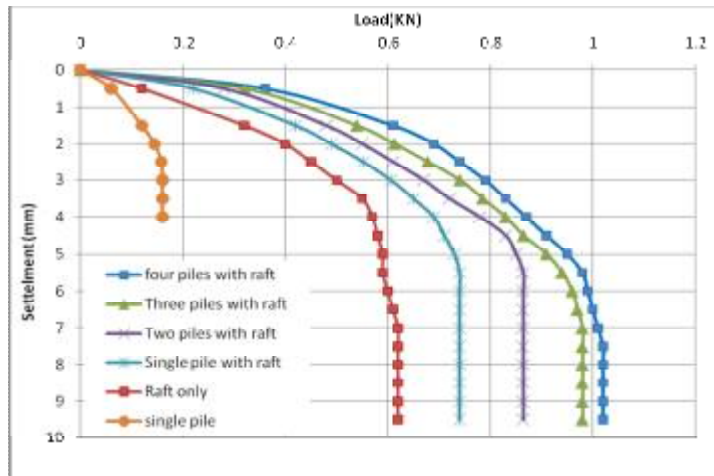

Figure (19) Load–displacement curves of the small model for the all cases.

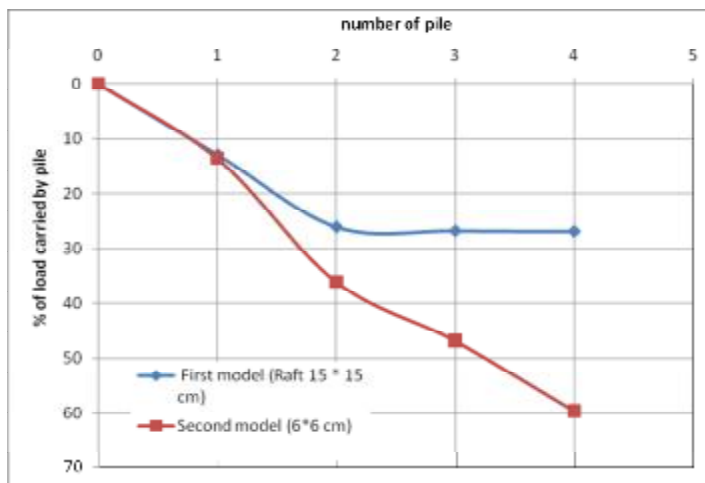

Figure (20) Effect of the scale for the two model.



Plate (1) Plastic rigid container.



Plate (2) Loading Machine.

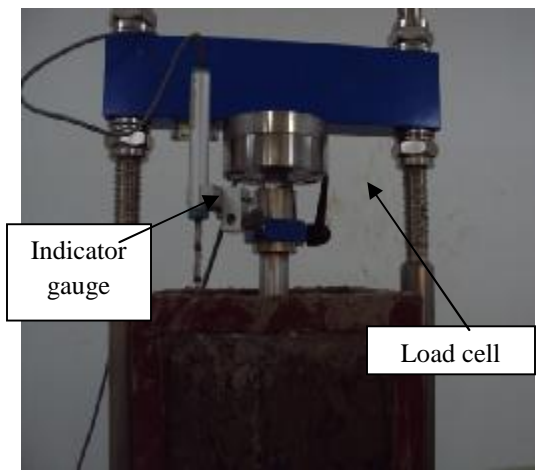

Plate (3) Load cell and indicator gauge



Plate (4) Monitor



Plate (5) Load cell anted indicter



Plate (6) Apparatus of the van shear gauge



**Plate (7) Single pile with ra
ft after test .**



Plate (8) Two piles with raft after test.