

Investigation of the Dowel and Friction Forces in Fiber Reinforced Ultra High Performance Concrete Beams

Dr. Kaiss F. Sarsam

Building and Construction Engineering Department, University of Technology/ Baghdad
Email: kaissarsam@yahoo.com

Dr. Maha M. S. Ridha

Building and Construction Engineering Department, University of Technology/ Baghdad

Zainab H. Mahdi 

Institute of Technology/ Baghdad.

Received on: 9/10/2011 & Accepted on: 7/6/2012

ABSTRACT

The phenomenon of dowel action as a shear transfer mechanism across cracks has long been recognized as an important component of the overall shear resistance capacity of reinforced concrete beams. The dowel contribution to shear depends primarily on the tensile resistance of concrete along the splitting plane and the bending resistance of the longitudinal bars. Fiber Reinforced Ultra High Performance Concrete (FRUHPC) is an advanced cementitious material consisting of a dense, high strength matrix containing a large number of evenly embedded steel fibers. Therefore, FRUHPC can be expected to improve dowel and friction resistance to shear.

This paper reports the experimental study of the components of shear force applied to FRUHPC beams, especially the effects of friction shear force and dowel action. Six FRUHPC beams (120*150*1500)mm dimensions with and without preformed cracks were made with three volume fractions of fibers: 1% , 1.5% and 2%. The presence of steel fibers enhances the performance of shear transfer mechanisms by friction or interface shear along the diagonal crack surface. Thus the contribution of this mechanism to the total shear strength carried by the beam was around 36.4% for FRUHPC beam with 2% fibers content. In the absence of friction or interface shear along the diagonal crack surface mechanism (preformed cracks beams) dowel action was the predominate contributor. However, the contribution of this mechanism to the total shear strength carried by the beam was around 45.4% for HPRPC beam with 2% fibers content. Also, an expression for evaluating the dowel force is presented in this research. The coefficient of multiple determination (R^2) was (0.835).

Keywords: Dowel action, Friction force, High performance, Fibers, Reactive powder concrete.

استقصاء قوى الوتد والاحتكاك في عتبات الخرسانة العالية الاداء المسلحة بالالياف

الخلاصة

ان ظاهرة سلوك الوتد والتي تمثل انتقال القص خلال الشقوق تعتبر مركبة مهمه من مقاومة القص الكلية للعتبات الخرسانية المسلحة. حيث ان مساهمة الوتد للقص تعتمد بشكل اساسي على مقاومة الشد للخرسانة على طول مستوى الانتشار ومقاومة الانتشاء للقضبان الطولية. ان الخرسانة العالية الاداء المسلحة بالالياف هي مواد اسمنتية متطورة تتكون من عجينه كثيفة عالية المقاومة وتحتوي على عدد كبير من الياف الحديد المغمورة فيها لذا من المتوقع تحسن في مقاومة الوتد والاحتكاك للقص.

هذا البحث يقدم دراسة عملية لمكونات قوى القص وسلوك الوتد لعتبات الخرسانة العالية الاداء المسلحة بالالياف خصوصا تأثير قوة قص الاحتكاك و سلوك الوتد. تم فحص 6 عتبات خرسانية مسلحة بابعاد (1500*150*120) ملم مع او بدون الشقوق المصنعة وتم استخدام ثلاث نسب من الالياف 1%، 1,5% و 2%. ان وجود الياف الحديد يحسن ميكانيكية انتقال القص عن طريق الاحتكاك على طول سطح الشق القطري. لذا فان مقدار مقاومة القص المنتقلة عن طريق هذه المركبة تكون حوالي 36.4% من قوى القص الكلية التي تتحملها عتبة بمحتوى الياف 2%. عند غياب مركبة الاحتكاك على طول الشق القطري في العتبات ذات الشقوق المصنعة فان مركبة سلوك الوتد هي المتحكمه بمقاومة القص للعتبة حيث انها تتحمل 45.4% من مقاومة القص الكلية للعتبة. كذلك تم اشتقاق علاقة لايجاد قوة الوتد في هذا البحث وكان معامل التقدير المتعدد (R^2) حوالي 0.835

INTRODUCTION

FRUHPC has exceptional mechanical and transport properties including a very high compressive and tensile strength, durability, and a density leading to a very low permeability making it ideal for the rehabilitation and modification of existing structures⁽¹⁾. Regarding its tensile behavior, FRUHPC belongs to the group of high performance fiber reinforced cementitious composites (FRUHPC), but offers the additional advantage of a very dense low-permeability matrix. A research program was initiated to characterize many of the behaviors relevant to the use of FRUHPC in the highway bridge industry⁽¹⁾.

The behavior of reinforced concrete beams as stated in the ACI-ASCE Committee 426⁽²⁾ report depends on the method of shear transmission.

Little research is presently available on shear strength of FRUHPC.

If the longitudinal reinforcement of a beam is loaded by a component of a force acting perpendicular to the reinforcement bars this is called dowel action.

There are two possible failure modes of the dowel mechanism:

- (1) yield of the bar and concrete crushing under the dowel.
- (2) concrete splitting laterally or below the reinforcing bars.

The underside concrete cover is the main parameter on which the mode of the dowel mechanism depends. The more frequent case is failure mode (2) in reinforced beams because of their small concrete cover in comparison with the bar diameter.

The comparison of the concrete cover with the net width at the side of the bars determines if the splitting cracks open either at the bottom or at the side of a cross section. In beams with usual dimensions the opening of the crack at the side of the reinforcement is the more usual case of failure⁽³⁾.

Therefore the following test programmes to determine the dowel-splitting load were carried out, that is the force at which the concrete splits.

RESEARCH SIGNIFICANCE:

In this paper an attempt has been made to discuss in some detail shear stress contribution of different elements of FRUHPC members.

The dowel action and the development of the splitting failure mechanism which is frequently seen in reinforced concrete beams without stirrups with small span/depth ratio was studied in this work. In this work, investigation is carried out on pre-cracked beams, similar to the work by Taylor⁽⁴⁾ on ordinary concrete.

EXPERIMENTAL INVESTIGATION

Materials and Mix Design

The cement used in this research was Tasloja ordinary Portland cement (ASTM Type I). Densified silica fume⁽⁵⁾ from Sika Materials Company in Baghdad has been used as a mineral admixture added to the mixtures of the research. The used percentage is 25% of cement weight (as an addition, not as replacement of cement).

Fine silica sand known as glass sand is used. This type of sand is produced in Al- Ramadi Glass factory. The fineness modulus is 2.32. The steel fibers used in this test program were straight steel fibers manufactured by Bekaert Corporation. The fibers have the properties described in Table (1) which is brought from China, a new generation of modified superplasticizer, Sika[®] Viscocrete[®] PC20⁽⁶⁾, is used. The mix design of FRUHPC using local constituent is 1:1: 0.25 (cement :sand :silica fume) with water cement ratio 0.2 plus 2% by weight of binder of Sika[®] Viscocrete[®] PC20 admixture.

Table (1): Properties of The Steel Fibers*

Description	straight
Length	13 mm
Diameter	0.2 mm
Density	7800 kg/m ³
Tensile Strength	2600 MPa
Aspect Ratio	65

*Supplied by the manufacturer

In this study, the steel reinforcement ratio used was (0.39)mm as flexural reinforcement. Yield strengths of the 10, and 16 mm bars were 658, and 520 MPa, respectively.

The hardened specimens were demolded after 24 hours. They were steam cured at about 80°C for 48 hours in a water bath. After that the samples were left to be

cooled at room temperature, then placed in water and left until the end of water curing at 28 days.

Six FRUHPC beams with cross-section of 120mm width and 150mm height were made with different percentages of steel fibers content. These beams were cast to study the contribution of different shear elements.^(3,4,7) This comprised three reinforced FRUHPC beam (B1-1, B2-1, and B3-1) without preformed diagonal cracks (Group I) and three reinforced FRUHPC beams (B1-2, B2-2, and B3-2) with preformed diagonal cracks (Group II). The test variable was the steel fibers content, V_f , which was varied from 1% to 2%.

Beams with preformed cracks (Group II) were identical to the beams without preformed cracks (Group I) in all respects, except that a smooth diagonal crack was introduced in the Group II beams by using a thin steel plate of 0.5 mm thickness which eliminated the interface shear. The inclined part of the plate was covered with 4mm sheets of expanded polystyrene which was removed with a thin knife after stripping the form as shown in Fig.(1). The width of the plate was the same as that of the beam, i.e. 120mm, and the beam had a preformed crack in the two short sides of the beam span. The position of the diagonal crack was determined from the diagonal failure cracks observed in beam (B1-1, B2-1, and B3-1) in Group I beams up to the loading point. Fig.2(a),(b),(c) shows specimen details and the position of the preformed cracks. All beams with and without preformed cracks were 1500 mm long, 120 mm wide, 150 mm deep and of 120 mm effective depth. The ratio ρ_w was 3.9% and the a/d ratio was 3.3. The summary of the concrete mix design is given in Table (2).

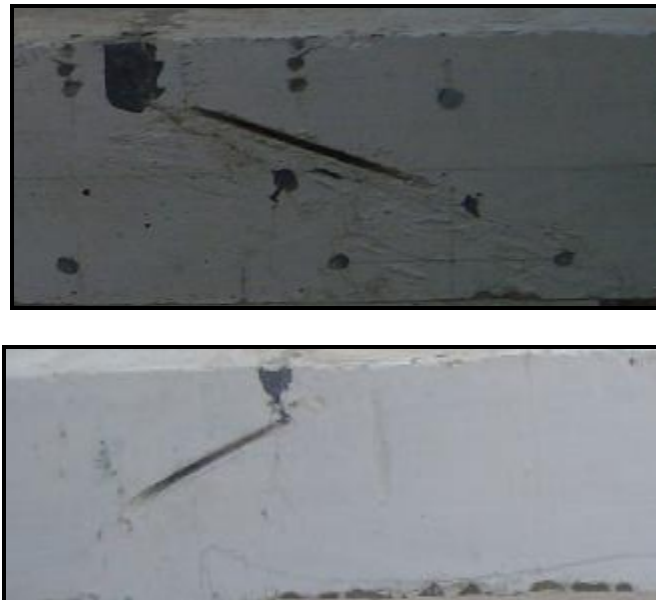
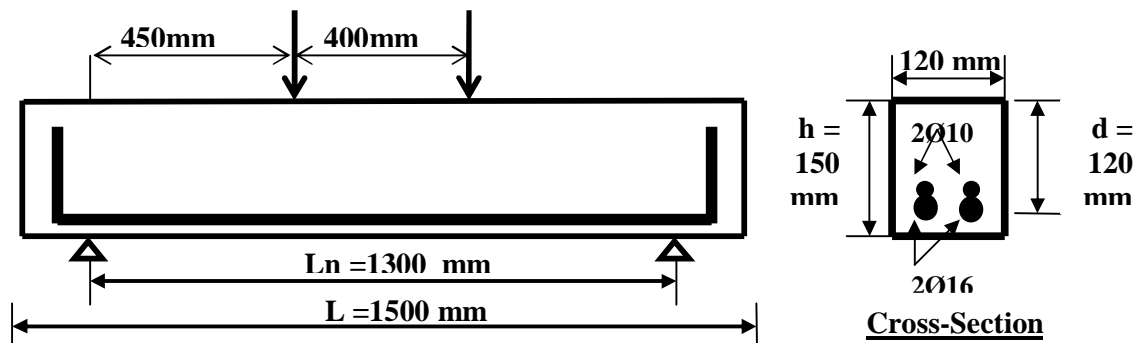

Figure (1) Preformed Cracks Beams (Group II).

Table (2): FRUHPC Mix Properties

Beam	C (kg/m ³)	S (kg/m ³)	SF (kg/m ³)	SP (L/m ³)	V _f (%)	W/C	f _c (MPa)	f _{sp} (MPa)	f _r (MPa)
B1-1(group I)	1000	1000	250	19.55	1	0.2	111	14.9	17.2
B2-1(group I)	1000	1000	250	19.55	1.5	0.2	121	16.2	19.7
B3-1(group I)	1000	1000	250	19.55	2	0.2	134	18.6	21
B1-2(group II)	1000	1000	250	19.55	1	0.2	111	14.9	17.2
B2-2(group II)	1000	1000	250	19.55	1.5	0.2	121	16.2	19.7
B3-2(group II)	1000	1000	250	19.55	2	0.2	134	18.6	21

C=Cement, S=Sand, SF=Silica fume, SP=Superplasticizer, V_f=Volume fraction of steel fibers, W=Water, f_c=Compressive strength(100*200 cylinder), f_{sp}=Splitting tensile strength (100*200 cylinder) f_r=Flexural tensile strength (100*100*400 specimens)



(a) Beam Details of Group I

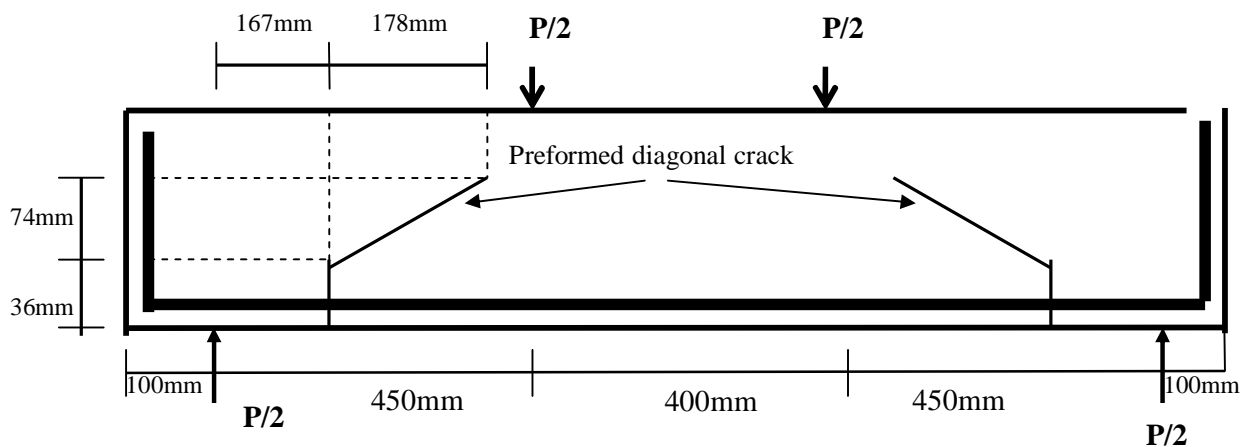

(b) Beam Details of Group II

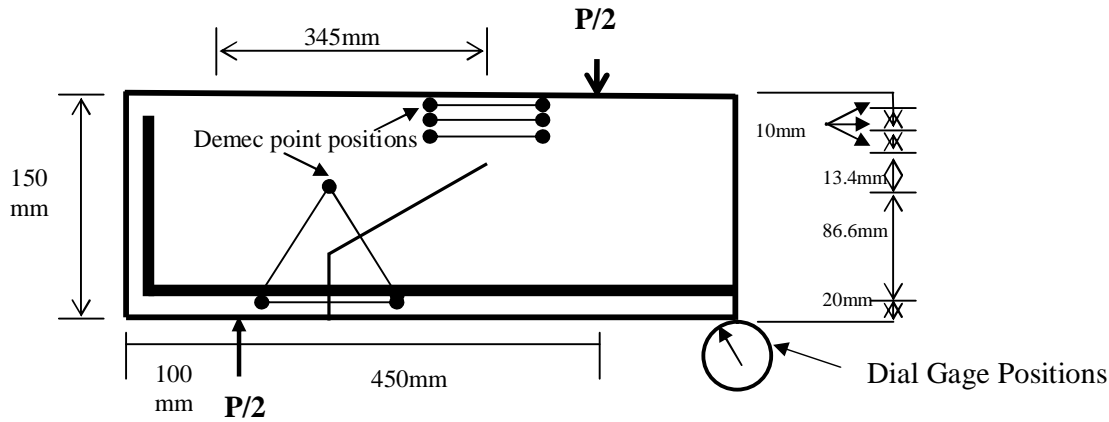

(c) Location of Demec Points and Dial Gage.

Figure (2) Details of Beams.

RESULTS, ANALYSIS AND DISCUSSION

1.Estimation of Shear Carried by Different Mechanisms

1.1.Shear Carried by The Compression Zone

A semi-empirical method, originally developed by Taylor ⁽⁴⁾, was employed to estimate the shear carried by the compression zone, V_{cz} , from strain reading taken at different levels along the beams depth ⁽⁸⁾.

The contribution of compression zone, V_{cz} , to shear was computed analytically from concrete strain readings measured at different levels across the beam depth, adopting Taylors semi-empirical approach, which is explained below.

The equation used is:

$$v_{cz} = \int_0^y \frac{ds}{dM} \frac{dM}{dX} dy$$

Where v_{cz} = shear stress at depth y from the compression face and at a distance x from the support; σ = longitudinal stress at a distance x from the support; M = moment at a distance x from the support.

The calculation of v_{cz} involves the following steps:

- 1) Plot strain, ϵ , against bending moment, M , for each gauge level and from this the slope $\frac{de}{dM}$ of the plot at every gauge level is determined.
- 2) Determine the total shear, $\frac{dM}{dX}$, for the load stage under consideration.

This has a constant value at any load stage for all the gauge level.

- 3) Determine $\frac{ds}{dM} \frac{dM}{dX}$ by multiplying the product of expressions in step (1), (2) and the modulus of elasticity of concrete, E_c .
- 4) Integrate the expression in step (3) from the compression face down to each gauge level to determine the shear stress at that gauge level.
- 5) Integrate the expression in step (4) from the compression face down to the inclined shear crack to determine the shear force carried by compression zone.

Shear Carried by Ddowel Action

The compression zone shear force, V_{cz} , was computed analytically from the longitudinal strain readings taken in the compression zone of the beam. The dowel shear force, V_d , was postulated to be equal to the numerical difference between the total shear and the shear contribution due to compression zone mechanism⁽⁹⁾, i.e.:

$$V_d = V_u - V_{cz}$$

As can be seen from Figs.(3-5), the dowel action provided the predominate shear force in all the beams compared with the compression zone contribution.

1.3.Shear Carried by Friction or Interface Shear Along The Diagonal Crack Surface

As described earlier the friction mechanism was eliminated from beams (Group II) by performing smooth diagonal cracks. Consequently, the difference in shear between beams of GroupI and GroupII should represent the shear force carried by the friction, V_a . The details of GroupII beam are given in Fig.(2).

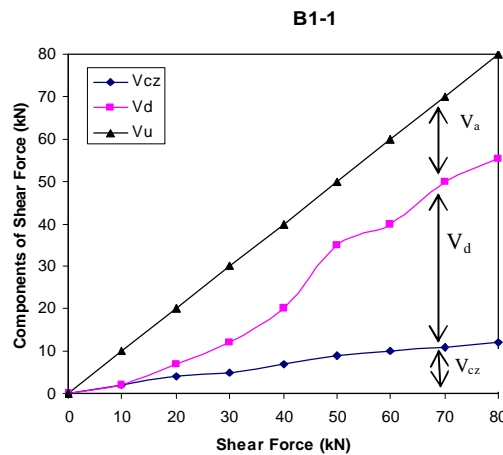

Figure (3) Components of the Resisting Shear Force(B1-1,Group II Beam).

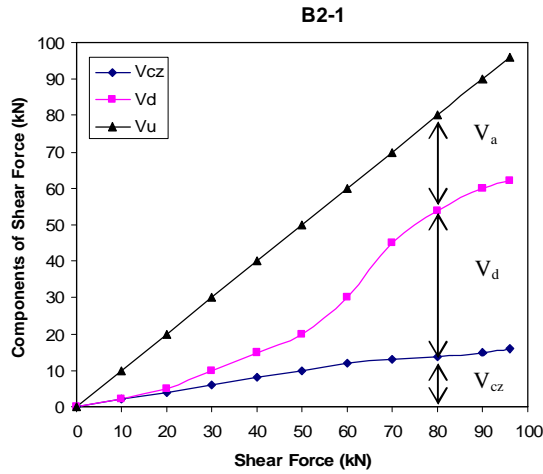

Figure.(4) Components of the Resisting Shear Force(B2-1,Group II Beam).

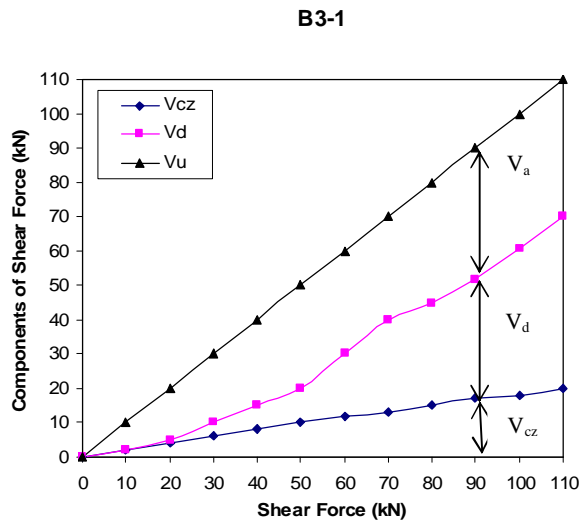

Figure (5) Components of the Resisting Shear Force(B3-1,Group II Beam).

Load-Displacement Relationship

Fig.(6) shows the load-displacement relationship of the beams made out of the mentioned several fiber contents V_f of the FRUHPC. It shows that specimens with the higher fiber content are able to carry higher loads at the same values of displacement. This is connected with the relation of the volume friction of steel fibers and tensile strength of concrete.

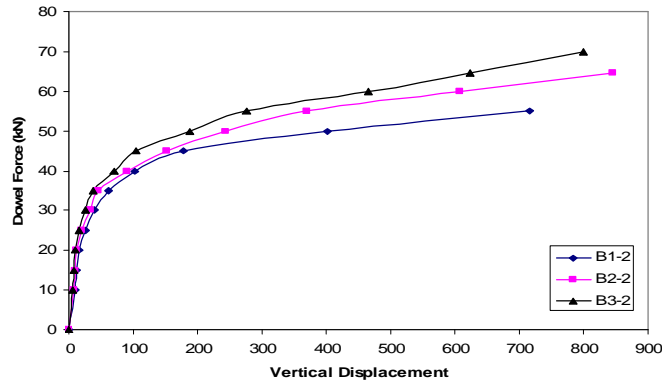

Figure (6) Load-Displacement Relation for HPRPC Beams

Contribution of Shear Mechanism Δ^* (10⁻³mm) at Ultimate Load

Fig.(7) illustrates the shear capacity Δ^* (10⁻³mm) of B3-1, B1-2, B2-2, and B3-2 beams at ultimate load. The shear contribution by friction, V_a , at any steel fibers content V_f should be the difference between the curves representing Group I and Group II. The shear force contribution by the compression zone, V_{cz} , and dowel action, V_d , are also shown in Fig.(7). The contributions of various shear transfer mechanisms represented in terms of the total shear capacity, V_u , are given in Table(3).

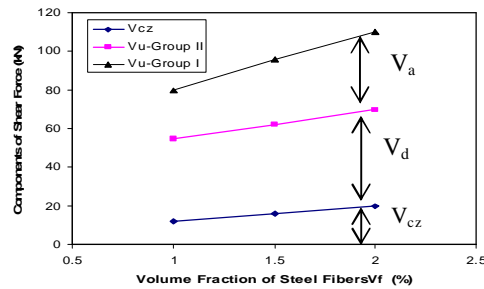

Figure (7) Contribution of Shear Mechanisms at Ultimate Load.

Table (3): Ultimate Shear Capacity and Element Shear Contribution.

Beam			RPC beams without preformed diagonal crack Group (I)	Beam	RPC beams with preformed diagonal crack Group (II)		
	f_c (MPa)	V_f (%)	V_u (kN)		V_u (kN)	V_{cz} (kN)	V_d (kN)
B1-1	111	1	80	B1-2	55	12	43
B1-2	121	1.5	96	B2-2	62	15	47
B1-3	134	2	110	B3-2	71	19	52

Significance of Friction or Interface Shear Along the Diagonal Crack Surface

The presence of steel fibers enhances the performance of shear transfer mechanisms by friction or interface shear along the diagonal crack surface. This is mainly due to the existence of fibers across the diagonal crack which restricts the crack propagation through the shear span and tends to tie up the crack opposite sides towards each other.

In this manner, the shear transfer by this mechanism was further maintained. In addition, such a condition brought about a new additional "fiber shear transfer mechanism" which was not found in beams without fiber reinforcement. A part of the shear load was transferred by this mechanism through the effectiveness of the steel fibers in carrying such a load and transferring it to the surrounding FRUHPC matrix. Therefore, several diagonal cracks were observed on all fibrous beams with relatively high percentage of fibers, thus indicating the redistribution of stresses until the complete pullout of all fibers occurred at one critical crack. In other words, the contribution of this mechanism to the total shear strength carried by the beam was around 36.4% for FRUHPC beam with 2% fibers content.

Significance of Compression Zone Shear

The test results indicated clearly that increasing steel fibers enhance slightly the performance of shear transfer mechanisms by the compression zone.

Significance of Dowel Action

As a result of the sectional rotation about the compression zone, caused by flexure, shear displacement is created along the critical horizontal and diagonal cracks. The vertical displacement at the level of the flexural reinforcement cannot develop unless either the flexural reinforcement or the surrounding concrete deforms. Thus, a resistance is induced at the level of the flexural reinforcement, which is the dowel action. Moreover, it introduces tensile stresses in the concrete surrounding the flexural reinforcement. As this stress exceeds the tensile strength of concrete, splitting occurs along the reinforcement.

The results indicated clearly that the shear carried by dowel action, V_d , is a predominant contributor to the ultimate shear load carried by the beam. However,

the contribution of this mechanism to the total shear strength carried by the beam was around 45.4% for FRUHPC beam with 2% fibers content.

The influence of fiber content and flexural tensile strength of concrete on ultimate dowel force is shown in Figs.(8-9). It is clear that the contribution of the fiber in increasing the dowel force is greater than its contribution in increasing the flexural strength.

From the results of this investigation, the following expressions relate the ultimate dowel force of HPRPC beams to flexural tensile strength and fiber content as shown in Figs.(8-9).

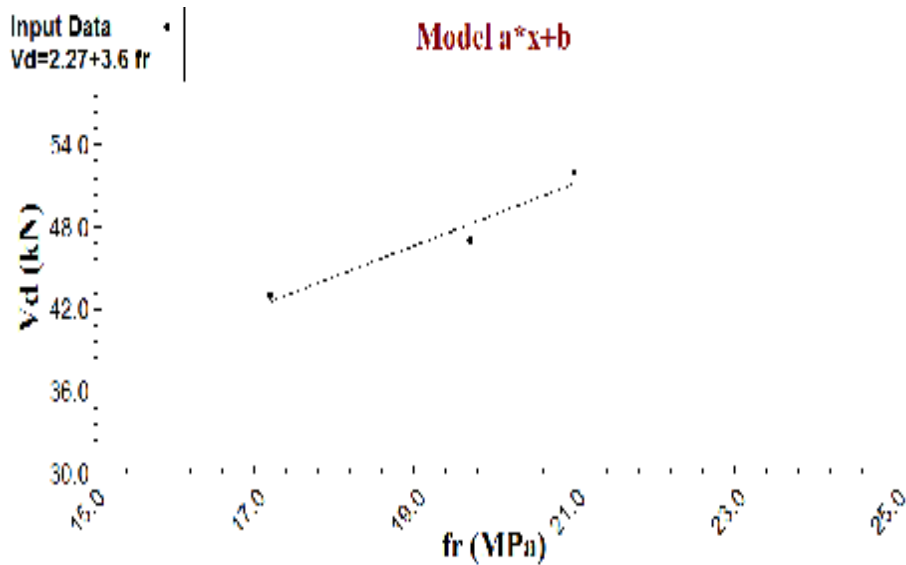

Figure (8):Influence of Flexural Tensile Strength on the Ultimate Dowel Force

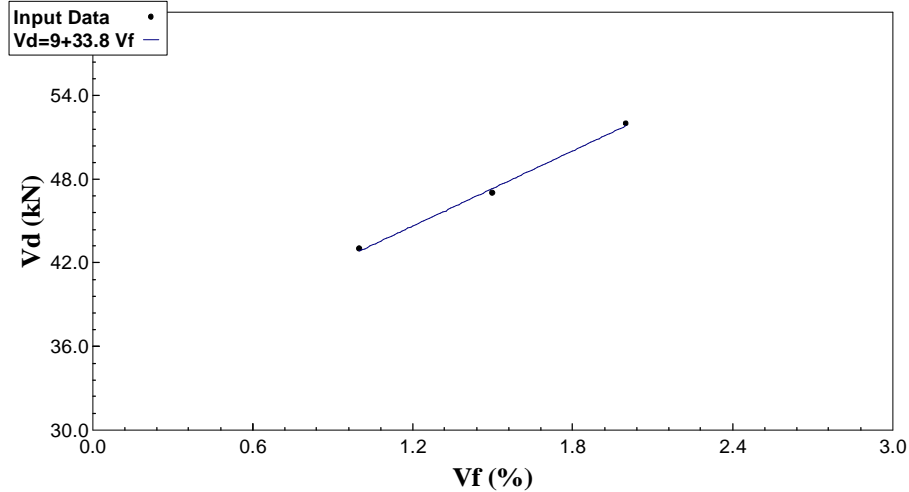

Figure (9):Influence of Fiber Content on the Ultimate Dowel Force

4.Proposed Formula for Predicting Dowel Force

The dowel force of reinforced concrete beams can be empirically predicted by regression analysis from the following formula :

$$V_d = 2.947 * \rho_w * b_n * \sqrt{f_r} + (V_f)^2 \quad \text{kN} \dots\dots(1)$$

where:

b_n =net width at the side of the bars,

ρ_w = longitudinal reinforcement ratio,

f_r =flexural tensile strength,

and V_f =volume fraction of steel fibers percentage.

Fig.(10) shows the test values of dowel force versus the proposed values of dowel force based on results of this research and Swamy research⁽¹⁰⁾ using Eq.(1) where the coefficient of multiple determination (R^2) was (0.835).

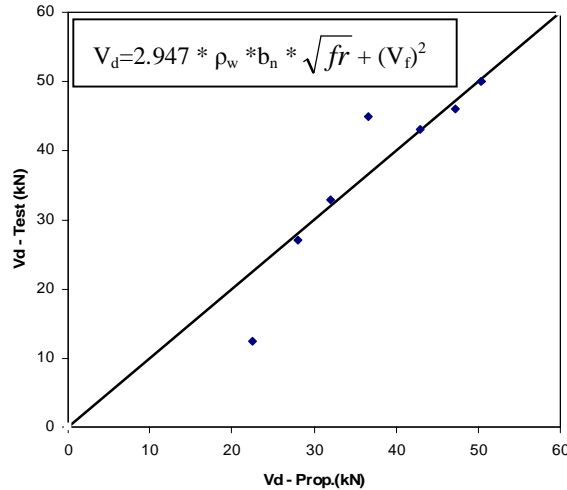

Figure.(9):Tests Values Versus Proposed Values of Ultimate Dowel Force Using Eq.(1).

Conclusions

1-In the absence of friction or interface shear along the diagonal crack surface mechanism dowel action was the predominate contributor. However, the contribution of this mechanism to the total shear strength carried by the beam was around 45.4% for HPRPC beam with 2% fibers content.

2-For beams having fiber content in the range of $1\% \leq V_f \leq 2\%$ the shear contribution of various components at ultimate state was found to be:

Shear component	Volume fraction of steel fibers V_f (%)		
	1	1.5	2
V_{cz}	12	15	19
V_d	43	47	52
V_a	25	34	39

3- The presence of steel fibers enhances the performance of shear transfer mechanisms by friction or interface shear along the diagonal crack surface through the effectiveness of the steel fibers in carrying such a load and transferring it to the surrounding FRUHPC matrix. The contribution of this mechanism to the total shear strength carried by the beam was around 36.4% for FRUHPC beam with 2% fibers content.

4- From the results of this investigation, the following expressions relates the ultimate dowel force of FRUHPC beams to flextural tensile strength and fiber content.

$$V_d = 2.27 + 3.6 f_r$$

$$V_d = 9 + 33.8 V_f$$

5- Based on test result obtained from this investigation and Swamy and Bahia results⁽⁹⁾, the dowel force of FRUHPC beams can be proposed by the following formula :

$$V_d = 2.947 * \rho_w * b_n * \sqrt{f_r} + (V_f)^2$$

REFERENCES

- [1]. Graybeal, B., " *Compressive Behavior of Ultra-High-Performance Fiber-Reinforced Concrete* ", ACI Materials Journal, V.104, No.17, Mar-Apr, 2007, pp. 146-152.
- [2]. ACI-ASCE Committee 426, " *The Shear Strength of Reinforced Concrete Members* ", J. Struct. Div., ASCE, Vol.99, No.6, June 1973, PP.1091-1187.
- [3]. Dehn, F., and He, T., " *Dowel Action in High Performance Lightweight Aggregate Concrete* ", LACER No.4, 1999, PP.203-213.
- [4]. Taylor, H. P. J., " *Investigation of The Forces Carried Across Cracks in Reinforced Concrete Beams in Shear by Interlock of Aggregate* ", Cement and Concrete Association, Technical Report 42-477. London, November, 1970, 22 PP.
- [5]. ASTM C 1240 – 2003, " *Standard Specification for Use of Silica Fume as a Mineral Admixture in Hydraulic-Cement Concrete, Mortar, and Grout* ", Vol. 04.02, 2003, pp.1-6.
- [6]. " *Sika[®] ViscoCrete[®] Hi-Tech PC20* ", Product Data Sheet, Turkey, pp. 1-3, www.sika.com.tr.
- [7]. Mphonde G. Andrew, and Frantz, C. Gregory, " *Shear Strength of High Strength Reinforced Concrete Beams* ", Research Project, Department of Civil Engineering, University of Connecticut, June 1984, 260 PP.
- [8]. Sarkar, S. Adwan, O., and Bose, B., " *Shear Stress Contribution and Failure Mechanisms of High Strength Reinforced Concrete Beams* ", Materials and Structures , Scientific Reports V.32, 1999, PP.112-116.
- [9]. Bunni, Z. K. , " *The Effect of The Shear Span to Depth Ratio on The Shear Strength of The High Strength Concrete Beams* " , M. Sc. Thesis , University of Technology , Baghdad , 1994 , 120 PP.
- [10]. Swamy, R. N. and Bahia, H. M., " *Influence of Fiber Reinforcement on the Dowel Resistance to Shear* " , ACI Journal , Proc. V.76, No.2, Feb. 1979, PP.327-355.