

## COMPUTER AIDED DESIGN OF RIVETS FOR STEAM BOILER SHELLS

M.Sc. Farah Kamil Abid Muslim  
Department of Mechanics  
Technical Institute/ Dewanya  
Dewaniya, Iraq  
Farah\_saleh77@yahoo.com

Dr. Essam L. Esmail  
Department of Mechanical Engineering  
College of Engineering, University of Qadisiya  
Dewaniya, Iraq  
Dr.essamesmail@yahoo.com

### ABSTRACT

Most mechanical CAD software used in mechanical design involves different types of decisions. All these decisions require coordinate-geometric and descriptive data. The objective of this work is to establish software programs for designing and analyzing rivets for boiler shells as an example to use rivets in industry. In general rivets are considered as mechanical elements of wide range application.

A software program using Visual Basic Version 5 with ACCESS database is used for design of rivets. When the user enters the input data to the system and depending on existing database, the software carries out a series of complex computations, after which it produces a comprehensive report that includes all engineering dimensions and efficiency.

The program, designed in this research, has feasible ability to deal with data base in an easy and reliable way especially for unprofessional users. This is a database that can be updated and edited at any time to get proper results. The program can be applied also to different types of riveted joint.

**KEYWORDS:** CAD, Mechanical design.

### تصميم برشام صفيحة المرجل البخاري باستخدام الحاسوب

د. عصام العبيبي اسماعيل  
كلية الهندسة / جامعة القادسية  
العراق / الديوانية

م. م. فرح كامل عبد مسلم  
قسم الميكانيك  
المعهد التقني/ الديوانية

### الموجز

معظم برامج التصميم المعان بالحاسوب للأجزاء الميكانيكية تتضمن إمكانية اتخاذ انواع مختلفه من القرارات. وكل هذه القرارات تتطلب إحدائيات للبيانات الهندسية بالإضافة إلى البيانات الوصفية. الهدف من هذا البحث هو تأسيس برامج حاسوبية لتصميم وتحليل برشام صفيحة المرجل البخاري (boiler shell rivet) كمثال على تصميم البراشيم ، اذ من المعروف بصوره عامه أن البراشيم هي واحده من الأجزاء الميكانيكية المهمة الواسعة الاستخدام.

يتضمن البحث: بناء نظام حاسوبي لتصميم برشام صفيحة المرجل البخاري حيث تم بناء هذا النموذج باستخدام برنامج بلغة الفيچوال بيسك الإصدار الخامس مع قاعدة بيانات أكسس ACCESS، فعندما يقوم

## Farah Kamil Abid Muslim, Essam L. Esmail

المستخدم بإدخال البيانات الى النظام ، يقوم النظام بسلسلة عمليات حسابية معقدة بالاعتماد على قاعدة البيانات الموجودة في النظام ثم يقدم تقريراً مفصلاً عن جميع الأبعاد الهندسية لبرشام صفيحة المرجل البخاري وكذلك كفاءته.

البرنامج الذي تم تصميمه في هذا البحث له امكانية التعامل مع قواعد البيانات بشكل متين وطريقة سهلة على المستخدم بحيث تسمح لأصحاب الخبرة البسيطة من المستخدمين في العمل عليها بسهولة وهي عبارة عن قاعدة بيانات جيدة قابلة للتحديث والتعديل في اي وقت للحصول على نتائج البرنامج بطريقة سليمة. كما ويمكن تطبيق البرنامج ايضا على انواع مختلفة من الربط باستخدام البرشام.

### NOMENCLATURE

$p_b$  = Back pitch

C = Constant,

CAD= Computer aided design,

$d$  = Rivet Hole Diameter,

$d_1$  = Rivet Diameter,

D = Internal diameter of boiler shell,

DXF= Finite element method,

$l$  = Shell length section,

m = Margin,

$n$  = Number of rivets

$N$  = Number of rows

P = Steam pressure in boiler,

$P$  = Pitch,

$P_r$  = Caulking pitch,

t = Thickness of the boiler shell,

$t_c$  = Thickness of the Cover Plate

$\sigma_t$  = Permissible tensile stress,

$\sigma_h$  = Hoop stress,

$\sigma_l$  = Longitudinal stress,

$\sigma_c$  = Crushing stress,

$\tau$  = Shearing stress

$\eta_l$  = Efficiency of the longitudinal joint, and

$\eta$  = Lap joint efficiency.

### 1. INTRODUCTION

A rivet is a short cylindrical bar with a head integral to it. The cylindrical portion of the rivet is called shank or body and lower portion of shank is known as tail, as shown in **Figure1**. Rivets are used to make permanent fastening between the plates such as in structural work, ship building, bridges, tanks and boiler shells. The riveted joints are widely used for joining light metal.

The boiler and pressure vessels are cylindrical in shape and withstand internal pressure. The cylindrical pressure vessel is identified by two dimensions, viz., the length and diameter. The cylinders are made from plates and whole length may not be obtained from single sheet hence cylindrical sections are obtained by bending sheets and joining edges by riveted joint. The sections are then joined together by another riveted joint along circumference. Thus there are two types of joint longitudinal

## COMPUTER AIDED DESIGN OF RIVETS FOR STEAM BOILER SHELLS

and circumferential (see **Figure 2**). The longitudinal joint will bear hoop stress ( $\sigma_h$ ) and circumferential joint bears longitudinal stress ( $\sigma_l$ ). Since  $\sigma_h = 2 \sigma_l$ , the longitudinal joint will have to be two times as strong as circumferential joint. Therefore, longitudinal joints are always made butt joints whereas the circumferential joints are made as lap joints.

CAD system were developed from simple graphic editors to be powerful systems that hold millions of standard part stored inside them with influent abolition to analyze, find design errors and identify weak point, in addition to powerful physical and analytical simulations that give exact solutions and accurate predictions.

This paper is dedicated to build a software program which includes all the mathematical design considerations for boiler shell rivets. This software program generates the geometric design data.

### 2. LITERATURE REVIEW

(**Casu and others, 1997**) studied the structural behavior of a riveted joint during cooling after hot heading. They found that the semi-empirical formulation used for this purpose cannot justify the strength of the joint. They established that stresses inside the rivet and the jointed elements are lower than the yield point, differently from previous calculations. (**Citarella and Gerbino, 2004**) developed a CAD/CAE methodology for coupling design, oriented to an efficient integration, between CAD systems and boundary element solvers, this methodology is based on a synergetic and strictly integrated usage of the pro/ENGINEER CAD system for geometric model generation, and. (**Hussam, Wissam & Baraa, 2005**) built an automatic dimensioning procedure by creating a DXF format. The initial drawing and its dimensions are displayed automatically on AutoCAD package window at one time. (**Haitham and others, 2004**) introduced an educational software called Eccentric loading. It is a user friendly and yet powerful tool for the analysis and design of riveted and bolted joints that are subjected to eccentric loads. (**Jarfall, 1986**) made an attempt to review the state-of-the-art in procedures for designing and optimizing bolted or riveted joints. Methods and data desired for the design procedure were defined and compared with what is available to day. Following major steps in the design procedure were covered: Calculation of the force distribution in the joint, which requires methods and data to account for fastener flexibility, eccentricities and bending support from surrounding structure; Calculation of the fatigue quality or the fatigue life, which requires that the influence from bypass stress, load transfer and secondary bending on the fatigue performance must be known for various combinations of material qualities (of the joined members), hole qualities and fastener types. (**Maskow, 1985**) reported that “the first successful beginnings towards rationalizing and humanizing” the structural assembly of civil aircraft, in this particular case in the production of riveted joints, have currently been made: A riveting system for spherically shaped aircraft frame structures has been specified, projected and tested for the assembly of aircraft shells. He described a 5-axis-CNC riveting equipment, in which an optical sensor system provides the possibility of compensating variations automatically by means of component tolerances. (**Patronelli, 1999**) remarked that numerous kinds of rivets have to be modeled for simulation of aeronautical framework crashes. For this kind of application, the authors modeled rivets with equivalent elements. Failure mode of such elements was defined with a mixed shear/tension law. To characterize rivet failure under mixed mode loading, experiments and FE simulation of the ARCAN test procedure were undertaken with a 7050 aluminum alloy countersunk rivet. Results showed that both approaches predict well the rivet failure criterion. Moreover, FE tools also resolved design related problems of new riveted joint assemblies more rapidly and cost effectively than experiments. An analytical and optimization method was used to identify the parameter of a mathematical failure criterion of the riveted joint.

### 3. RESEARCH METHODOLOGY

**3.1. Data Preparation:** The necessary information for this system is shown in **Figure 3**. They are:

- Type of joint (lap joint or butt joint)

**Farah Kamil Abid Muslim, Essam L. Esmail**

- Tensile stress ( $\sigma_t$ )
- Crushing stress ( $\sigma_c$ )
- Shearing stress ( $\tau$ )
- Working pressure (P)

**3.2. The developed system:** This system is developed specifically to design and analyze rivet of boiler shell. The developed system can perform several functions as depicted in **Figure 3**. Each function interface with the other functions.

**3.2.1. User interface:** The user interface main module plays a key role in various system activities, by providing the possibility of accessing any part of the system. User interface is the communication mechanism between the user and other modules of the system. When the user enters the needed inputs through the user interface, the system designs and anglicizes the rivets of the boiler shell depending on the given inputs.

**3.2.2. Common Database:** the database must contain high level information about the product, because in such system we need common database that supports the user interface. This database consist of rivet-hole diameter and rivet diameter tables, type of joint, efficiency, and value of maximum pitch constant.

**3.2.3. Design and analyze Module:** To design boiler shell rivets and to determine the geometric design data, this will be done as following:

#### **3.2.3.1. Design of boiler shell rivets**

##### **1. Design procedure for longitudinal butt joint**

###### **• Determine Thickness of Boiler Shell ( $t$ )**

The efficiency of the joint is chosen from **Table 1** and for pressure  $\sigma_r$ , inner diameter  $D$  and permissible tensile stress  $\sigma_t$ , the thickness is calculated from,

$$t = \frac{P.D}{2\sigma_t \times \eta_t} + 1 \text{ mm} \quad (1)$$

The diameter and thickness will further guide in respect of rivet arrangement. **Table 2** can be used for this purpose.

###### **• Determine Rivet Hole Diameter ( $d$ ) and Rivet Diameter ( $d_1$ )**

Unwin's formula, giving  $d \leq 6\sqrt{t}$  is used if  $t \geq 8$  mm. In very rare case if  $t < 8$  mm,  $d$  is calculated by equating shearing strength and crushing strength of rivet. The diameter of hole must be rounded off to the nearest standard value with the help of **Table 3**, and the diameter of rivet also established.

###### **• Determine Pitch of the Rivet ( $p$ )**

The minimum pitch is  $2d$  to accommodate the dies to form head. The pitch is calculated by equating tearing strength with shearing or crushing strength of rivet(s). However, the pitch should not exceed

## COMPUTER AIDED DESIGN OF RIVETS FOR STEAM BOILER SHELLS

certain value for leak proof nature of the joint. The maximum value of  $p$  is given by following equation.

$$P_{\max} = C \times t + 41.28 \text{ mm} \quad (2)$$

The value of  $C$  is given in **Table 4**. If by calculation  $p$  turns out to be less than  $p_{\max}$ , it will be acceptable.

### • Determine Back Pitch ( $p_b$ )

(a) For both lap and butt joints having equal number of rivets in different rows  $p_b$  is given as:  
for zig-zag riveting,

$$p_b = (0.33 p + 0.67 d) \text{ mm} , \quad (3)$$

and for chain riveting

$$p_b = 2d \text{ mm} \quad (4)$$

(b) For joints in which number of rivets in outer rows is half of that in inner rows which are chain riveted  $p_b$  should be greater of the values calculated from Equations (3) and (4). However, the value of  $p_b$  for rows having full number of rivets will not be less than  $2d$ .

(c) The third case arises for joints having inner rows zig-zag riveted and outer rows having half the number of rivets as inner rows where

$$p_b = (0.2 p + 1.15 d) \text{ mm} \quad (5)$$

The back pitch for zig-zag riveted inner rows will be:

$$p_b = (0.165 p + 0.67 d) \text{ mm} \quad (6)$$

The pitch  $p$  in above equations is the one in outer row, i.e. away from butting edges.

### • Determine Thickness of the Cover Plate ( $t_c$ )

(a) For single butt cover with chain riveting:

$$t_c = 1.125 t \quad (7)$$

(b) For single cover with pitch in the outer row being twice that in the inner row:

$$t_c = 1.125 \left( \frac{p - d}{p - 2d} \right) t \quad (8)$$

(c) For double cover of equal width and chain riveting:

$$t_c = 0.625 t \quad (9)$$

(d) For double cover of equal width with pitch in the outer row being twice that in the inner row:

$$t_c = \left( \frac{p - d}{p - 2d} \right) t \quad (8)$$

(e) For double cover of unequal width (wider cover on the inside):

$$\left. \begin{aligned} t_{c1} &= 0.75 t && \text{(for cover on the inside )} \\ t_{c2} &= 0.625 t && \text{(for cover on the outside )} \end{aligned} \right\} \quad (11)$$

Determine margin,

$$m = 1.5 d \quad (12)$$

• **Determine Caulking Pitch,  $pt$**

The pitch of rivets in the row nearest to the edge must be as small as possible to avoid leakage. This pitch is called caulking pitch and helps edges to be caulked effectively (see **Figure 4**). A rough rule is that this pitch should not be greater than  $S_{tc}$ . The caulking pitch is, however, calculated from following:

$$p_c = d + 13.8 \frac{t_c^{3/4}}{\sigma_{12}^{1/4}} \quad (13)$$

This is an empirical relation in which  $\sigma_r$  the pressure is used in  $N/mm^2$ .

**2. Design procedure for circumferential lap joint.**

The thickness of the shell, the diameter of the rivet hole, back pitch and margin are calculated in the same way as for longitudinal butt joint. The other quantities are presented under.

• **Number of Rivets ( $n$ )**

The rivets are in single shear and all of them are subjected to shear when pressure,  $\sigma_r$  acting on the circular section of the cylindrical space tends to separate two length sections of the vessel.

So  $n \tau_s \frac{\pi}{4} d_1^2 = \sigma_r \frac{\pi}{4} D^2$  and

$$n = \frac{\sigma_r D^2}{\tau_s d_1^2} \quad (14)$$

• **Pitch, ( $p$ )**

Efficiency of the lap joint  $\eta$  can be taken as half of the efficiency of the longitudinal butt joint. The efficiency of the lap joint is calculated on the basis of tearing load capacity of the joint which turns out to be least of strengths in all modes.

Thus,

$$\eta = \frac{p - d}{p} \quad (15)$$

• **Number of Rows, ( $N$ )**

The rivets are placed all along the circumferences of the shell. Hence number of rivets in one row is

$$n_1 = \pi(D + t) / p$$

Hence total number of rivets in  $N$   $n_1 = n$ .

$$N = \frac{n p}{\pi(D + t)} \quad (16)$$

## COMPUTER AIDED DESIGN OF RIVETS FOR STEAM BOILER SHELLS

Whether the joint will be single riveted or multiple riveted will be decided by  $N$ . If  $N$  turns out to be less than 1, a single riveted joint will serve the purpose. In any case the pitch will have to satisfy the condition of caulking.

- **Overlap of Shell Length Section ( $l$ )**

$$l = (N - 1) p_b + 2m \quad (17)$$

### 4. RESULTS AND DISCUSSION

To show the validity of our approach and for the purpose of completeness, an illustrative design example is introduced here.

Inner diameter of a boiler is (1500 mm) and the steam pressure is ( $2 \text{ N/mm}^2$ ). Use a proper joint along the length and design it completely. The following permissible stress values will be used

Tension  $\sigma_t = 90 \text{ MPa}$

Shear  $\sigma_s = 75 \text{ Mps}$

Crushing  $\sigma_c = 150 \text{ MPa}$

- **Thickness of the Shell ( $t$ )**

From Table (2) for shell diameter of (1500 mm) a double riveted butt joint is recommended and from Table (1) we can use an efficiency of (80%).

$$t = \frac{\sigma_r D}{2\sigma_t \eta} + 1 \text{ mm} = \frac{2 \times 1500}{2 \times 90 \times 0.8} + 1 = 20.8 + 1 = 21.8 \text{ mm say } 22 \text{ mm}$$

- **Rivet Hole Diameter ( $d$ )**

$$d = 6\sqrt{t} = 6\sqrt{22} = 28.14 \text{ mm}$$

The nearest standard value of hole diameter is 28.5 mm, and corresponding rivet diameter is 27 mm.  $d_1 = 27 \text{ mm}$ .

- **Pitch ( $p$ )**

In one pitch length there are two rivets which may shear or crush (**Figure 5**).

The shear strength of one rivet in double shear

$$P_{s1} = 1.75 \times \frac{\pi}{4} d_1^2 \tau_s = 1.75 \times \frac{\pi}{4} (27)^2 \times 75 = 75.2 \text{ kN}$$

The crushing strength of one rivet

$$P_{c1} = t d_1 \sigma_c = 22 \times 27 \times 150 = 89.1 \text{ kN}$$

The rivet is weaker in shearing. Equating tearing strength of plate with shearing strength of 2 rivets in a pitch length,

**Farah Kamil Abid Muslim, Essam L. Esmail**

$$(p - d) t \sigma_t = 2 \times 1.75 \times \frac{\pi}{4} d_1^2 \tau_s$$

$$p = 3.5 \times \frac{\pi}{4} (27)^2 \times \frac{75}{22 \times 90} + 28.5 = 104.4 \text{ mm}$$

Check for maximum value of pitch from Eq. (2). From **Table 4** for two rivets in a pitch length for a double cover double riveted joint the value of ( $C = 3.5$ ).

$$P_{\max} = C \times t + 41.28 = 3.5 \times 22 + 41.28 = 118.28 \text{ mm}$$

The min. pitch is  $2d$ . Hence calculated value of  $p = 104.4$  mm is acceptable. We may choose  $p = 105$  mm.

**Back Pitch ( $p_b$ )**

$$p_b = 0.33 p + 0.67 d = 0.33 \times 105 + 0.67 \times 28.5$$

$$p_b = 34.65 + 19.1 = 53.75 \text{ mm}$$

However,  $p_b$  should not be less than  $2d$  or 57 mm  
 $p_b = 57$  mm.

**Thickness of Cover Plate ( $t_c$ )**

The joint has two equal cover plates. From Eq. (9)

$$t_c = 0.625 t = 13.75 \text{ mm}$$

**Margin ( $m$ )**

$$m = 1.5 d = 42.75 \text{ mm}$$

**Efficiency ( $\eta$ )**

The shearing strength of the joint

$$P_s = 2 \times 75.2 = 150.4 \text{ kN}$$

The crushing Strength of the joint

$$P_c = 2 \times 89.1 = 178.2 \text{ kN}$$

The tearing strength of plate with holes

$$P_t = (p - d) t \sigma_t = (105 - 28.5) 22 \times 90$$

$$P_t = 151.47 \text{ kN}$$

The tensile strength of plate without holes



## COMPUTER AIDED DESIGN OF RIVETS FOR STEAM BOILER SHELLS

$$P = pt \sigma_t = 105 \times 22 \times 90 = 208 \text{ kN}$$

$P_s$  is least of  $P_s$ ,  $P_c$  and  $P_t$

$$\eta = \frac{P_s}{P} = \frac{150.4}{208} = 72.3\%$$

The application of the proposed system is introduced here.

**Figure 7** shows the proposed input frame and the result .By entering the following data(Inner diameter of a boiler, Steam pressure, Tensile stress, Crushing stress, and Shearing stress), and by using the type of joint and efficiency database in **Figure 8** and **9**, the results are thickness of the Shell ( $t$ ).

**Figure 10** shows the calculation of Rivet Hole Diameter ( $d$ ) and Rivet Diameter ( $d_1$ ) that depends upon the corresponding rivet diameter database as shown in **Figure 11**.

**Figure 12** shows the proposed input frame and the result .By entering the following data (number of rivet in one pitch length) ), and by using the Value of Constant for Maximum Pitch from database in **Figure 13**, the results are (Shear strength of one rivet, Crushing strength of one rivet, Pitch, Maximum pitch, and Back Pitch).

**Figure 14** shows the calculation of (Thickness of Cover Plate ( $t_c$ ), Margin ( $m$ ), Shearing strength of the joint, Crushing Strength of the joint, Tearing strength of plate with holes, Tensile strength of plate without holes, and Efficiency)

### 4. CONCLUSIONS

In this study, software is developed for automating the design analysis of rivets for boiler shells. The aim of the development of this software is to present a method for effective use of general purpose programs in the design analysis. The software developed is then used for evaluating the effects of design parameters on rivet of boiler shell characteristics.

The program is composed of user interface, which is composed in Visual Basic 5.0 with ACCESS database for design rivet, includes the forms for data input and result output procedures. It is a user-friendly and yet powerful tool for the analysis and design of rivet of boiler shell. The user starts the application by specifying his input data as one of the following (Inner diameter of a boiler, Steam pressure, Tensile stress, Crushing stress, and Shearing stress), by using the database, the results are (thickness of the shell, rivet hole diameter, rivet diameter, thickness of cover plate, Margin, shearing strength of the joint, crushing strength of the joint, tearing strength of plate with holes, tensile strength of plate without holes, and Efficiency).

With such a broad field of application, it would be expected that students of engineering as well as practicing design engineers will find this system to be a powerful tool that facilitates the accurate analysis and design of riveted or bolted joints of the lap or butt type.

**Farah Kamil Abid Muslim, Essam L. Esmail**

**REFERENCEES**

Casu A; Fregonese R; Garro A; Calderale PM., Mechanisches Verhalten von Heissnietverbindungen in Abhangigkeit von Abkuhlung und Creep, Stahlbau. v 66, n 1, Jan 1997, p 12-19.

Citarella and Gerbino," BE analysis of polygonal profiles shaft-hub couplings", 2004.

Hussam, Wissam & Baraa," An Integrated Approach To Design And Analyze Unprotected Type Flange Coupling", Al-Taqani, Vol.18, No.2, 2005.

Haitham, and others, "An Interactive Software for the Design of Riveted Joints", 2004.

Jarfall, L., Shear loaded fastener installations, Int. J. Vehicle Design. 1986. vol. 7, no. 3-4, pp. 337-380.

Kemal Çaliskan," Automated Design Analysis of Anti-Roll Bars", September 2003

Maskow, J., Use of automated riveting systems in aircraft construction, 30. National SAMPE Symposium and Exhibition, Anaheim, CA (USA), 19-21 Mar 1985.

Patronelli, L; Markiewicz, E; Langrand, B; Deletombe, E; and Drazetic, P., Analysis of riveted joint failure under mixed mode loading, European Journal of Mechanical and Environmental Engineering. v 44 n 4, Winter 1999, p 223-228.

## COMPUTER AIDED DESIGN OF RIVETS FOR STEAM BOILER SHELLS

**Table 1** Efficiencies of Commercial Boiler Joints

Maximum Efficiency %	Average Efficiency %	Type of Joint
63.3	45-60	Lap Joints
77.5	63-70	Single riveted
86.5	72-80	Double riveted
		Triple riveted
63.3	55-60	Butt Joints
86.6	70-83	Single riveted
95.0	80-90	Double riveted
98.1	85-94	Triple riveted
		Quadruple riveted

**Table 2** Suggested Rivet Arrangements

Rivet Arrangement	Thickness of Shell (mm)	Dia. of Shell (mm)
Double riveted	6-12.5	610-1830
Triple riveted	8-25.0	915-2130
Quadruple riveted	9.5-31.75	1525-2740

**Table 3** Standard Rivet Hole and Rivet Diameters

44	41	37.5	34.5	31.5	28.5	25	23	21	19	17	15	13	d (mm)
42	39	36	33	30	27	24	22	20	18	16	14	12	d1 (mm)

**Table 4** The Value of Constant for Maximum Pitch

Butt Joint Double Cover	Butt Joint Single Cover	Lap Joint	Number of Rivets
1.75	1.53	1.31	1
3.50	3.06	2.62	2
4.63	4.05	3.47	3
5.52		4.17	4
6.00			5

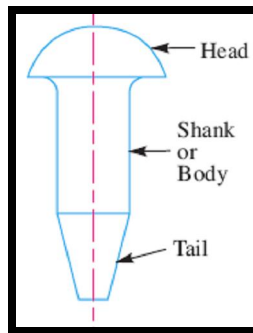

Figure 1 Rivet parts

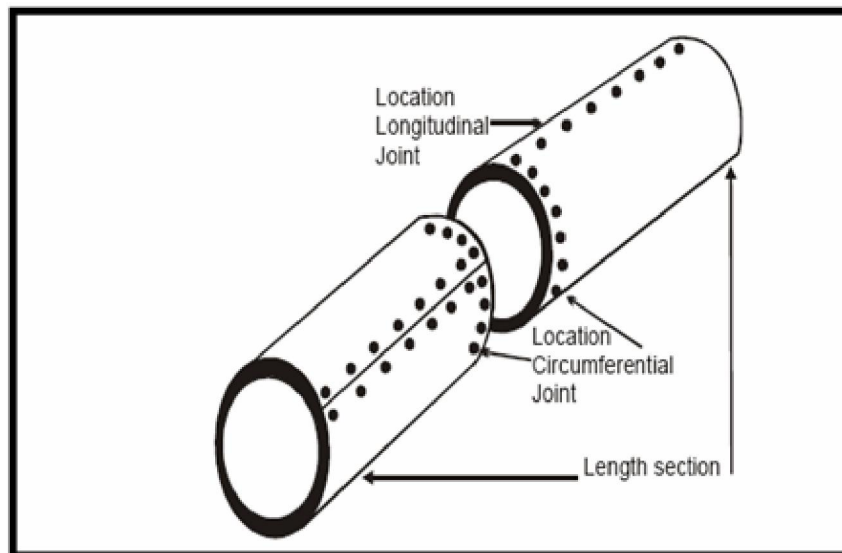

Figure 2 Longitudinal and Circumferential Location for Riveted Joints

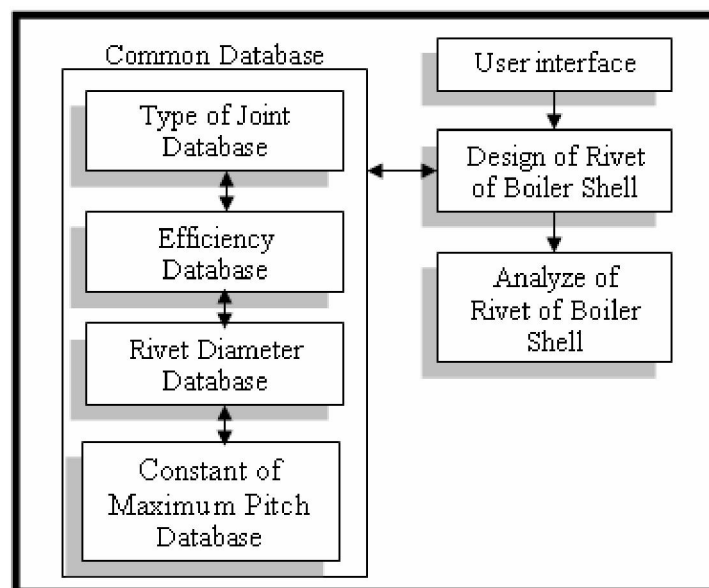
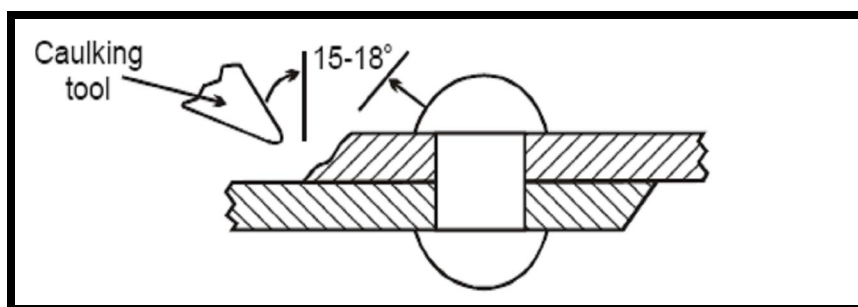
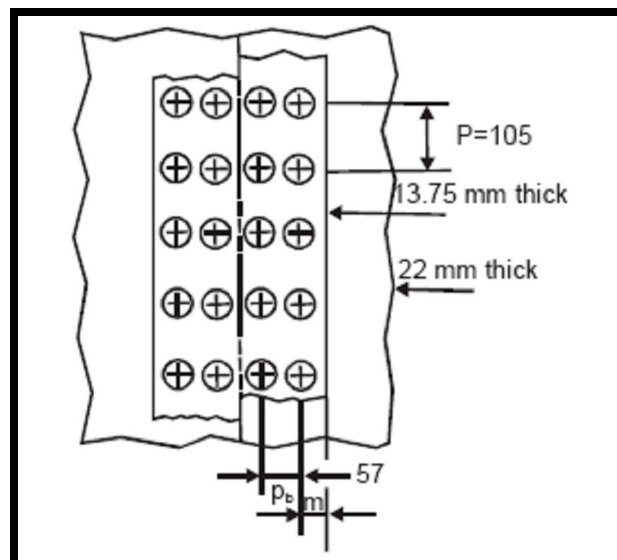

Figure 3 System architecture

## COMPUTER AIDED DESIGN OF RIVETS FOR STEAM BOILER SHELLS



**Figure 4** Caulking of riveted joint



**Figure 5**

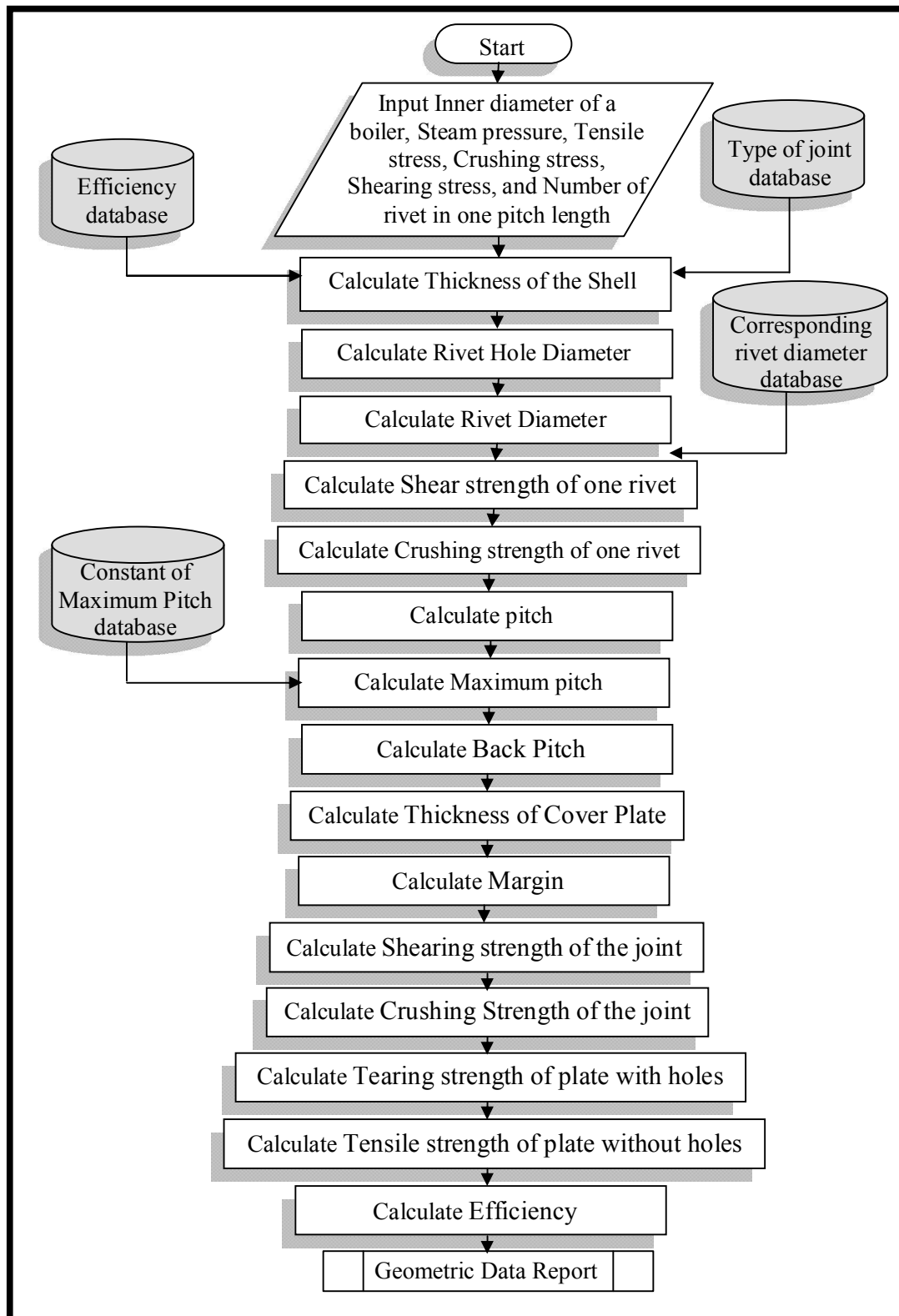

Figure 6 Flowchart for Design procedure of longitudinal butt joint

# COMPUTER AIDED DESIGN OF RIVETS FOR STEAM BOILER SHELLS

**Design procedure for longitudinal butt joint**

### 1) Thickness of boiler shell

**Input**

Inner diameter of a boiler: 1500 mm  
Steam pressure: 2 N/mm<sup>2</sup>  
Tensile stress: 90 MPa  
Crushing stress: 150 MPa  
Shearing stress: 75 MPa

Select type of joint from database  
Select efficiency from database

Type of joint: A double riveted butt joint  
Efficiency: 80%

Calculate Clear Exit

**RESULTS**

Thickness of the Shell (t): 22 mm

Figure 7 Calculate thickness of boiler shell frame

**Type of Joint Database**

Diameter of Shell (mm): 610-1830  
Type of Joint: Double riveted Butt Joint

Add Delete Refresh Update Close

Figure 8 Type of joint database frame

**Efficiency Database**

Type of Joint: Double riveted Butt Joint  
Efficiency: 80%

Add Delete Refresh Update Close

Figure 9 Efficiency database frame

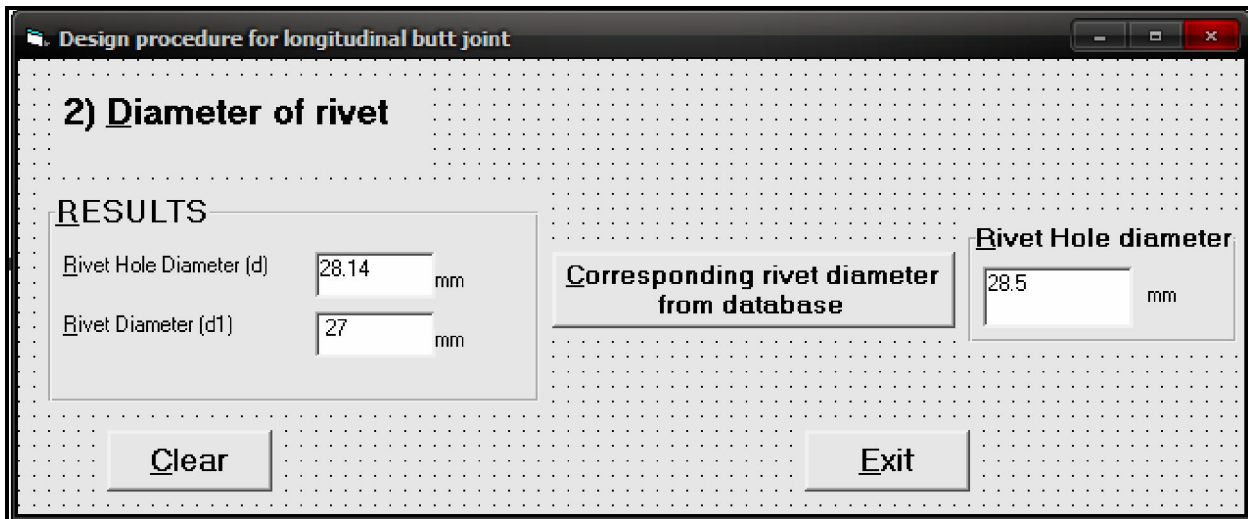

Figure 10 Calculate diameter of rivet frame

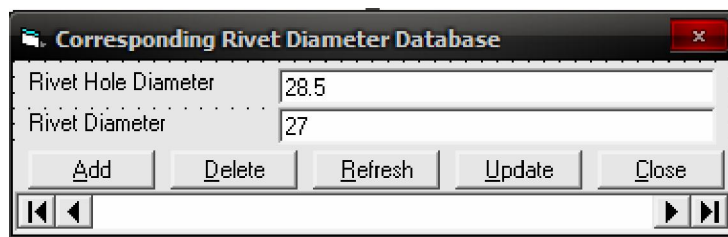

Figure 11 Rivet diameter database frame

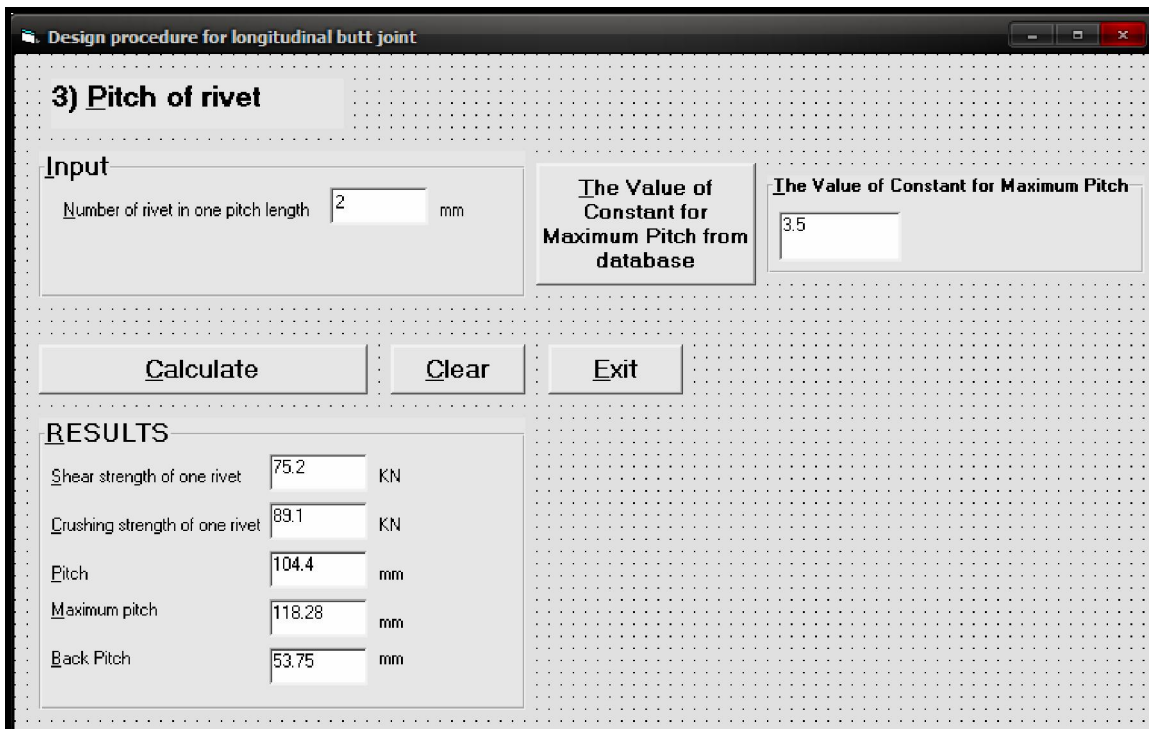
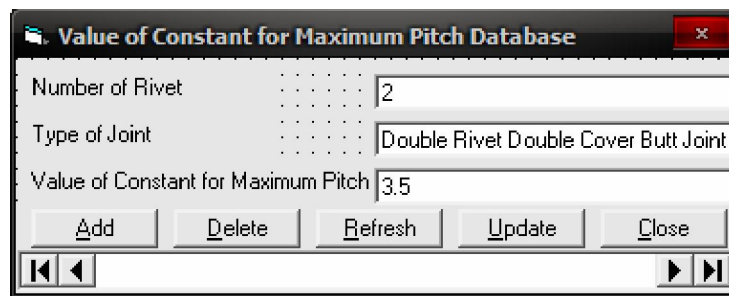

Figure 12 Calculate pitch of rivet frame



## COMPUTER AIDED DESIGN OF RIVETS FOR STEAM BOILER SHELLS



The dialog box titled "Value of Constant for Maximum Pitch Database" contains the following fields and controls:

- Number of Rivet: 2
- Type of Joint: Double Rivet Double Cover Butt Joint
- Value of Constant for Maximum Pitch: 3.5
- Buttons: Add, Delete, Refresh, Update, Close
- Navigation arrows: Home, Previous, Next, End

Figure 13 Value of constant for maximum pitch from database frame

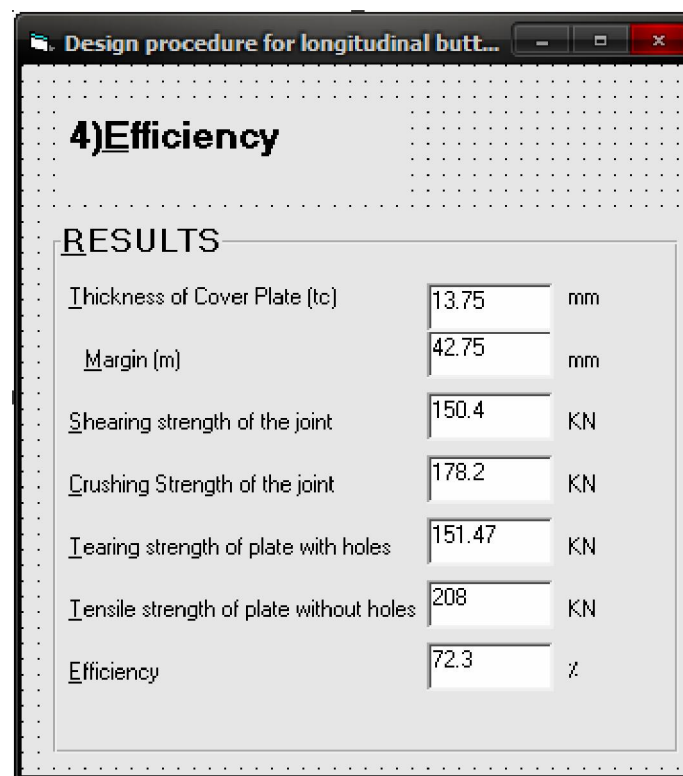

The dialog box titled "Design procedure for longitudinal butt..." displays the following results under the heading "4) Efficiency":

### RESULTS

Thickness of Cover Plate (tc)	13.75	mm
Margin (m)	42.75	mm
Shearing strength of the joint	150.4	KN
Crushing Strength of the joint	178.2	KN
Tearing strength of plate with holes	151.47	KN
Tensile strength of plate without holes	208	KN
Efficiency	72.3	%

Figure 14 Calculate efficiency frame