

Harmonics Distribution in Electrical Power System Containing Static Var Compensator

Mohammed K. Edan*

Received on: 3/3/2008

Accepted on: 9/10/2008

Abstract

This research presents a harmonic analysis of the power system with static VAR compensator. The model is formed by parallel combination of Thyristor Control Reactor (TCR) with a bank of capacitor. This model based on use of harmonic switching functions and this harmonic model is completely general and can be interpreted as a harmonic admittance equivalent. It is suitable for direct incorporation into the harmonic domain frame of reference where it combines easily with frequency dependent admittances of the transmission network, and with other linearised component. This approach leads to efficient iterative solution of power networks containing TCR. The general operating condition corresponds to a case, when the switching instant of thyristor valve are function of network nodal voltage conditions, this applies to both thyristor turn-on and turn-off instants. In such situation the voltage zero crossing points calculated with good accuracy at each iterative step, are used to update the TCR switching function. Newton-Raphson technique is used to determine the zero-crossing points.

Keywords: Harmonics, Static var compensator, Harmonic analysis

توزيع التوافقيات في منظومات القدرة الكهربائية التي تحتوي على معوضات
أستاتيكية للقدرة غير الفعالة

الخلاصة

يقدم هذا البحث تحليل للتوافقيات في منظومة القدرة المزودة بمعوض استاتيكي للقدرة. الانموذج مكون من مسيطر الثايرستور على المفاعلة مربوط على التوازي مع متسعة. هذا الانموذج يعتمد على استخدام دالة الفتح والغلق للتوافقيات. الانموذج عام يمكن تحويله الى مسايرة مكافئة للتوافقيات وبالإمكان دمجها مباشرة في حيز التوافقيات مع السايرة المعتمدة على التردد لشبكات النقل والاجزاء الأخرى. هذا التركيب يقود الى حل تكراري فعال للشبكات التي تحتوي على مسيطر الثايرستور على المفاعلة. شروط العمل العامة تعتمد على الحالة، لحضات الغلق و الفتح للثايروستر تعتمد على شروط فولتية العقدة للشبكة. في هذه الحالة نقاط تقاطع الفولتية مع الصفر تحسب بدقة عند كل تكرار وهذه القيمة تستخدم لتحديث دالة الغلق والفتح الى مسيطر الثايرستور على المفاعلة. استخدمت تقنية نيوتن رافسن لحساب نقاط تقاطع الفولتية مع الصفر.

List of Symbols

A_1 : Conduction area of thyristor 1.
 A_2 : Conduction area of thyristor 2.
 B_1 : Transmission line Susceptance (S)
 C: Capacitance of SVC (F).
 D: Matrix of differentiation.
 G_1 : Transmission line conductance(S)
 h: Harmonic order number.

$I_{L,f}(\alpha)$: Fundamental component of TCR current as function of firing angle (A).
 $I_{L,h}(\alpha)$: Harmonic component current of TCR as function of firing angle (A).
 I_L : Current of TCR reactor (A).
 $J_{11}, J_{12}, \dots, J_{33}$: Jacobean elements.
 k: Iteration counters.
 L: Inductor of TCR (H).

Electromechanical Engineering Department, University of Technology

<https://doi.org/10.30684/etj.27.3.11>

2412-0758/University of Technology-Iraq, Baghdad, Iraq

This is an open access article under the CC BY 4.0 license <http://creativecommons.org/licenses/by/4.0>

$P_{3\phi}$: Three phase active power (KW)
 $Q_{3\phi}$: Three phase reactive power (KVAR)
 R : Resistance at fundamental frequency (Ω)
 R_g, R_l, R_t : Resistance at fundamental frequency of generators, transmission lines ,and transformers respectively(Ω)
 S : Switching function.
 V_T : Voltage of TCR (KV).
 V_L : Reactor voltage of TCR.
 X_g : Generator sub transient reactance (Ω)
 X_l, X_t : Inductive reactance of transmission line and transformer respectively(Ω)
 Y_{TCR} : Harmonic admittance matrix of TCR(S).
 Y_{SVC} : Harmonic admittance matrix of SVC(S).
 Z_g, Z_l, Z_t : harmonic impedance of generator ,transmission line and transformer respectively(Ω) .
 ω_o : Angular velocity at fundamental frequency(rad/sec).
 α : Firing angle of thyristors.
 σ_1, σ_2 : Conduction angle of thyristor 1 and thyristor 2.
 θ_o : Voltage zero crossing angle of thyristor(deg).
 θ_{a1} : Starting conduction angle of thyristor1 (deg).
 θ_{a2} : Starting conduction angle of thyristor2 (deg).
 θ_{b1} : Turn off Angle of thyristor1(deg).
 θ_{b2} : Turn off Angle of thyristor2(deg).
 θ_x : Center of switching function(deg).

1. Introduction

The dynamic behavior of industrial loads such as rolling mills, arc furnace, traction loads and large fluctuating single-phase loads draw wildly fluctuating amounts of reactive power from the supply system .These loads cause unbalance on the system and leads to wide fluctuating in the supply voltage and effects like incandescent light flicker, disturbance in electric control circuits and computer equipments which are undesirable to the

consumer. These loads can handled best by compensator connected to the same bus and therefore requires the use of compensator that can be adapted to load change [1].As it frequently happens, the developing market needs have been answered by technology developments. Advances in high power semiconductor and sophisticated electronic control technologies have development of fast, Static Var Compensators (SVC). These are characterized by extremely rapid response, unrestricted operation, high reliability, and almost unlimited operating flexibility[2] .The use of power- electronics semiconductor – based devices in bulk power transmission for reactive power compensating brought an increased risk of harmonics distortion in the power network because several of these devices generates harmonic current. The significant effects of harmonics in power systems are the reduced equipment life (caused by deterioration of insulation),frequent maintenance and repair ,additional losses in the network ,improper operation of control ,protection and metering devices ,and interference with telecommunication systems [3].

2. Thyristor Controlled Reactor as Harmonic Source

Thyristor controlled reactor ,which have the ability to ensure continuous an fast reactive power and voltage control ,can increase the performance of the system in different ways such as control of transient over voltages at the power frequency ,increase in transient stability and decrease in system oscillation[4].The basis thyristor controlled reactor (TCR) is illustrated in figure(1) ,The thyristor controlled reactor consists of a reactor in series with two parallel inverse thyristor .The two inverse parallel thyristors are gated symmetrically. They control the time for which the reactor conducts and thus control the fundamental component of

the current. The thyristor conduct on alternate half-cycles of the supply frequency dependent on firing angle, which is measured from a zero crossing of voltage. Full conduction is obtained with a firing angle of 90. Under this condition, the current is reactive and its waveform is purely sinusoidal. If the conduction is delayed by equal amount on both thyristor, a series current waveform is obtained as shown in figure (2). Each of these correspond to a particular value of firing angle. Partial conduction is obtained with firing angles between 90 and 180. Figure (2) illustrates, the firing angle control results in a nonsinusoidal current waveform in the reactor, in the other word, the thyristor controlled reactor generates harmonics [2, 5]. Figure (2) show the reactor current $i_L(t)$ and its fundamental component $i_{L1}(t)$ for various firing angle, α . The magnitude of $i_{L1}(t)$ as a function of firing angle α :

$$I_{L1}(\alpha) = V_T / pX_L (2p - 2\alpha + \sin 2\alpha) \quad (1)$$

The fundamental frequency equivalent impedance of the TCR is readily available from (1):

$$X_{TCR} = pX_L / (2p - 2\alpha + \sin 2\alpha) \quad (2)$$

The thyristor controlled reactor harmonic current as function of firing angle α , given by the following expression:

$$I_{Lh}(\alpha) = \frac{4V_T}{pX_L} \left(\frac{h \sin \alpha \cosh \alpha - \cos \alpha \sinh \alpha}{h(h^2 - 1)} \right) \quad (3)$$

For $h=2k+1$, with $k=1, 2, 3, \dots$

In three phase system, three single phase thyristor controlled reactor used in star or delta connection as shown in figure (3) [1, 2, 5].

2.1. Operation of Thyristor Controlled Reactor

Expression for the current through the thyristor controlled reactor and the voltage across (TCR) can be developed. Figure (4) show the voltage and current waveforms in a (TCR). The thyristors are gated once each half cycle allowing control of the current in the reactor and thus allowing control of the reactive current drawn by the circuit. The voltage across the reactor $v_L(t)$, which can be represented by the terminal voltage, $v_T(t)$, multiplied by a switching function $s(t)$ [6,7]:

$$v_L(t) = s(t)v_T(t) \quad (4)$$

And

$$v_L(t) = L \frac{di_L(t)}{dt} \quad (5)$$

Equation (4) and (5) may be expressed in the harmonic domain as follows [8]:

$$V_L = SV_T \quad (6)$$

$$V_L = LD(jh\omega_o)I_L \quad (7)$$

Combining (6) and (7) yields,

$$I_L = Y_{TCR}V_T \quad (8)$$

Where the TCR harmonic admittance matrix Y_{TCR} is:

$$Y_{TCR} = \frac{1}{L} D^{-1}(jh\omega_o)S \quad (9)$$

And the matrix of differentiation $D(jh\omega_o)$ and its inverse $D^{-1}(jh\omega_o)$ are [9],

$$D(jw_o) = \begin{bmatrix} \bullet & 0 & 0 & 0 & 0 & 0 & 0 & 0 & 0 \\ 0 & \bullet & 0 & 0 & 0 & 0 & 0 & 0 & 0 \\ 0 & 0 & -2jw_o & 0 & 0 & 0 & 0 & 0 & 0 \\ 0 & 0 & 0 & -jw_o & 0 & 0 & 0 & 0 & 0 \\ 0 & 0 & 0 & 0 & 0 & 0 & 0 & 0 & 0 \\ 0 & 0 & 0 & 0 & 0 & jw_o & 0 & 0 & 0 \\ 0 & 0 & 0 & 0 & 0 & 0 & 2jw_o & 0 & 0 \\ 0 & 0 & 0 & 0 & 0 & 0 & 0 & \bullet & 0 \\ 0 & 0 & 0 & 0 & 0 & 0 & 0 & 0 & \bullet \end{bmatrix} \quad (10)$$

$$D^{-1}(jw_o) = \begin{bmatrix} \bullet & 0 & 0 & 0 & 0 & 0 & 0 & 0 & 0 \\ 0 & \bullet & 0 & 0 & 0 & 0 & 0 & 0 & 0 \\ 0 & 0 & j/2w_o & 0 & 0 & 0 & 0 & 0 & 0 \\ 0 & 0 & 0 & j/w_o & 0 & 0 & 0 & 0 & 0 \\ 0 & 0 & 0 & 0 & \infty & 0 & 0 & 0 & 0 \\ 0 & 0 & 0 & 0 & 0 & -j/w_o & 0 & 0 & 0 \\ 0 & 0 & 0 & 0 & 0 & 0 & -j/2w_o & 0 & 0 \\ 0 & 0 & 0 & 0 & 0 & 0 & 0 & \bullet & 0 \\ 0 & 0 & 0 & 0 & 0 & 0 & 0 & 0 & \bullet \end{bmatrix} \quad (11)$$

2.2. Voltage zero –Crossing Reference

The operation of the thyristor is a function of the voltage zero crossing, it starts conduction just after the voltage zero crossing is reached .The voltage zero crossing from one period of the voltage waveform to the next is a function of the voltage waveform at the point of connection .Figure (5) illustrates this point, where the zero crossing in a voltage waveform containing distortion is shown. If we assume that the TCR voltage zero crossing occurs at a time t [7, 8], when

$$v_T = \sum_{n=-\infty}^{n=\infty} V_{Tn} e^{jn w_o t} = 0 \quad (12)$$

or at an angle θ_o when

$$\sum_{n=-\infty}^{n=\infty} V_{Tn} e^{jn q_o} = 0 \quad (13)$$

Then it is possible to find the voltage zero –crossing occurs at a reference by solving (13) by iteration using Newton-Raphson method,

$$q_o^{(k+1)} = q_o^k - \frac{v_T}{v'_T} \quad (14)$$

where k is an iteration counter.

$$v_T = \sum_{n=-\infty}^{\infty} V_{Tn} e^{jn q_o^{(k)}} \quad (15)$$

And the derive of equation (15) is,

$$v'_T = \sum jn V_{Tn} e^{jn q_o^{(k)}} \quad (16)$$

The iterative solution of equation (15) requires that a suitable initial condition be selected, and a sensible practice is to assume a sinusoidal waveform as the starting condition .In this case the angle $\theta_o^{(0)}$ is given by [8],

$$q_o^{(o)} = \frac{P}{2} - angle(V_T (h + 2)) \quad (17)$$

2.3. Thyristor Turn –on and Turn-off

A realistic representation of the TCR should include the thyristor's turn-on turn-off action .Figure(6) illustrates the various parameters associated with TCR voltage waveform ,where turn –on and turn –off instants are represented .The TCR voltage zero crossing is taken as the reference for issuing the firing signal α .If the first thyristor fires at time θ_{a1} , the thyristor turns on and conducts for a period σ_1 .It turns off with the zero crossing of the thyristor's current ,at a time θ_{b1} .An equidistant firing scheme is assumed , $\theta_{a2} - \theta_{a1} = \pi$.In this figure the switching function $s(\theta)$ is also shown . The analysis starts at a time of voltage zero crossing θ_o , which may be expressed in terms of complex Fourier harmonic coefficient [7, 8].

$$v_T = \sum_{n=-\infty}^{n=\infty} V_{Tn} e^{jn q_o} = 0 \quad (18)$$

The end of the conduction period, given by the zero crossing of the thyristor current, occurs when the areas A_1 and A_2 are both zero.

$$A_1 = \int_{q_{a1}}^{q_{b1}} v_T dq = \sum_{n=-\infty}^{n=\infty} \frac{V_{Tn}}{jn} (e^{jnq_{b1}} - e^{jnq_{a1}})$$

$$= 0 \tag{19}$$

$$A_2 = \int_{q_{a2}}^{q_{b2}} v_T dq = \sum_{n=-\infty}^{n=\infty} \frac{V_{Tn}}{jn} (e^{jnq_{b2}} - e^{jnq_{a2}})$$

$$= 0 \tag{20}$$

$$q_{a1} = q_o - (p - a) \tag{21}$$

$$q_{a2} = q_{a1} + p \tag{22}$$

Solving equation (18), (19) and (20) for θ_o , θ_{b1} and θ_{b2} using Newton's method, the following equation is solved by iteration [8]:

$$\begin{bmatrix} q_o \\ q_{b1} \\ q_{b2} \end{bmatrix}^{(k+1)} = \begin{bmatrix} q_o \\ q_{b1} \\ q_{b2} \end{bmatrix}^{(k)} - \begin{bmatrix} J_{11} & J_{12} & J_{13} \\ J_{21} & J_{22} & J_{23} \\ J_{31} & J_{32} & J_{33} \end{bmatrix}^{-1} * \begin{bmatrix} v_T \\ A_1 \\ A_2 \end{bmatrix}^{(k)} \tag{23}$$

k is an iteration counter and the Jacobin elements are:

$$J_{11} = \frac{\partial v_T}{\partial q_o} = \sum_{n=-\infty}^{\infty} jnV_{Tn} e^{jnq_o}$$

$$J_{12} = \frac{\partial v_T}{\partial q_{b1}} = 0$$

$$J_{13} = \frac{\partial v_T}{\partial q_{b2}} = 0$$

$$J_{21} = \frac{\partial A_1}{\partial q_o} = - \sum_{n=-\infty}^{\infty} V_{Tn} e^{jn(q_o - (p - a))}$$

$$J_{22} = \frac{\partial A_1}{\partial q_{b1}} = \sum_{n=-\infty}^{\infty} V_{Tn} e^{jnq_{b1}} \tag{24}$$

$$J_{23} = \frac{\partial A_1}{\partial q_{b2}} = 0$$

$$J_{31} = \frac{\partial A_2}{\partial q_o} = - \sum_{n=-\infty}^{\infty} V_{Tn} e^{jn(q_o + a)}$$

$$J_{32} = \frac{\partial A_2}{\partial q_{b1}} = 0$$

$$J_{33} = \frac{\partial A_2}{\partial q_{b2}} = \sum_{n=-\infty}^{\infty} V_{Tn} e^{jnq_{b2}}$$

The initial conditions required for the solution of equation (23) may be taken to correspond to a sinusoidal waveform, which is given by the zero crossing of the fundamental component of v_T . The initial value for θ_o is given by equation (17), and the initial conditions for θ_{b1} and θ_{b2} can be given by assuming quarter-wave symmetry are [8]:

$$q_{b1}^{(o)} = q_o^{(o)} + (q_o^{(o)} - q_{a1}^{(o)}) \tag{25}$$

$$q_{b2}^{(o)} = q_{b1}^{(o)} + p \tag{26}$$

After convergence of the switching function $s(\theta)$ is taken to be at:

$$q_x = q_{a1} + \frac{s}{2} \tag{27}$$

where the conduction angles are given as:

$$s_1 = q_{b1} - q_{a2} \tag{28}$$

$$s_2 = q_{b2} - q_{a2} \tag{29}$$

Then θ_x , σ_1 and σ_2 are used to calculate the harmonic content of the switching

function given by [7]:

$$S_o = \frac{S_1 + S_2}{2p} \tag{30}$$

$$S_n = \frac{1}{np} \left(\sin \frac{nS_2}{2} \cos np + \sin \frac{nS_1}{2} \right) * e^{-jnq_x} \tag{31}$$

It should be noted that these equation are general. They cater for the case when the conduction periods of thyristors1 and 2 differ owing to the existence of voltage waveforms with loss of quarter -wave symmetry. Figure (7) shows the flowchart used for determined the switching function S.

3-Harmonic Model of Three Phases SVC

Three phases SVC harmonic model consists of three single phases SVC harmonic admittance, these admittance connected in star or delta connection, where the harmonic admittance matrix of star connection is [8]:

$$Y_{SVC} = \begin{bmatrix} Y_{SVC-a} & 0 & 0 \\ 0 & Y_{SVC-b} & 0 \\ 0 & 0 & Y_{SVC-c} \end{bmatrix} \tag{32}$$

And the harmonic admittance matrix of delta connection is:

$$Y_{SVC} = \begin{bmatrix} Y_{SVC-ab} + Y_{SVC-ca} & -Y_{SVC-ab} & -Y_{SVC-ca} \\ -Y_{SVC-ab} & Y_{SVC-bc} + Y_{SVC-ab} & -Y_{SVC-bc} \\ -Y_{SVC-ca} - Y_{SVC-bc} & Y_{SVC-ca} + Y_{SVC-bc} & \end{bmatrix} \tag{33}$$

4. Harmonic Model for Power System Elements

To form the harmonic impedance matrix at each harmonic frequency for power system network, harmonic model

for each systems element must be developed.

4.1. Generators

The generators are modeled as series combination or resistance and inductive reactance [10].

$$Z_g = R_g \sqrt{h} + jX_g h \tag{34}$$

Where R_g is derived from the machines power losses.

4.2. Transformers

These are considered to be liner elements whose harmonic impedance as [10, 11]:

$$Z_t = R_t \sqrt{h} + jX_t h \tag{35}$$

Where R_t derived from transformer power losses.

4.3. Transmission Line

The transmission line includes the line total inductance, resistance and conductance modeled as lumped parameter by (nominal π model) as in figure (8) .the series harmonic impedance is [10, 12]:

$$Z_l = R_l \sqrt{h} + jX_l h \tag{36}$$

And the harmonic admittance is:

$$Y_l = G_l + jB_l \tag{37}$$

Where

$$B_l = \omega C_l$$

4.4. Passive Elements

Passive elements are considered to behave linearly with frequency, such as inductor and capacitor .The harmonic impedance for inductor and capacitor are [8]:

$$X_L(h) = jhX_L \tag{38}$$

$$X_c(h) = -jX_c / h \quad (39)$$

4.5. Linear Load

These may be represented by three different models as below [8, 11]:

(i)Parallel R-X_L equivalent, where

$$R = V^2 / P_{3\Phi} \quad (40)$$

And

$$X_L(h) = jhV^2 / Q_{3\Phi} \quad (41)$$

(ii) Parallel R-X_L, with

$$R(h) = V^2 / kP_{3\Phi} \quad (42)$$

And

$$X_L(h) = jhV^2 / kQ_{3\Phi} \quad (43)$$

$$k = 0.1h + 0.9 \quad (44)$$

(iii) Parallel R-X_L in series with X_s,
Where

$$R = V^2 / P_{3\Phi} \quad (45)$$

And

$$X_L(h) = jhR / 6.7(Q_{3\Phi} / P_{3\Phi} - 0.74) \quad (46)$$

$$X_s(h) = j0.073hR \quad (47)$$

5. Block Diagram of Harmonic Analysis in system containing SVC

Figure (9) shows the approach to analysis harmonic in power system including SVC. This approach consists of the following steps.

1-Read the transmission lines parameters (R, X, and B),active and reactive power for each load bus, firing angle α ,thyristor controlled reactor

voltage V_T ,and harmonic order h.

2-Fundamental power flow solution is carried out for the system under study to drive fundamental frequency information for the voltage magnitudes and angles at all nodes of the network for use this information to calculate the parameters of linear loads impedance (R, X_L), and use this information in initial condition.

3-Determining the switching function S according to the flowchart in figure (7).

4-Calculate harmonic impedance matrix of TCR from equation (9) and calculate the harmonic impedance of SVC from equation (32) to star connection and (33) to delta connection.

5-Develop the harmonic model for each power system elements and perform the harmonic modeling of the SVC.

6-Perform the harmonic admittance matrix to the system under study and perform nodal harmonic voltages equation for the system under study.

7-Determine the harmonic voltages for all buses and harmonics currents flowing in all transmission lines in network by solving the nodal harmonic voltages equation.

8-Print and draw the result.

6. System under Study

Figure (10) shows a one line diagram of the system under study, buses one through five are 230 KV and the buses six through twelve are 115 KV .the transmission line and branch data are given in table (1), all base on (100MVA) [12].The static var compensator is three phase star connection simulated by a three phase TCR in parallel with bank of fixed capacitor. The loads (load2, load3, load4, load5, load7, load8, load9,

load10, load11, and load 12) in figure (10) are modeled by using the linear load model type (i).

7. Results

The fundamental load flow results are listed in table (2) and the magnitude of the impedance load buses determined from equation (40),(41).The loads impedances for each bus are listed in table(2).It is observe from the data listed in tables (3), (4),(5),(6), (7)and table (8) in cases for $\alpha=100$, $\alpha=120$, and $\alpha=150$ that the maximum harmonic voltage occurs at the bus directly connected to the SVC, figures (12), (16), and figure (20) show the maximum harmonic voltage to phase (a) at bus 3 for $\alpha=110$, $\alpha=120$,and $\alpha=150$ and figures(11),(15),and(19) show the spectrum of these voltages . It is also observe from tables that the highest harmonic current flowing on transmission lines directly connected to the bus whose SVC connected to it and the buses near this bus , figures(14),(18) ,and(22) show the largest harmonic current flowing in line2-3 for $\alpha=110$, $\alpha=120$,and $\alpha=150$ figures(13),(17),and (21) show the spectrum of these harmonic currents

8. Conclusion

From the results of cases studied, it appears that the harmonic current flows on system transmission lines can exceed the current injected by the SVC at any frequency .It was found that this happens when a transmission line reaches a resonant frequency. The highest harmonic current generates at third harmonic order for all cases study, therefore the highest harmonic voltage and harmonic current occur at third harmonic for all cases. The SVC generated maximum harmonic current at firing angle $\alpha=110$, therefore the

largest magnitude of harmonic voltage occurs at this value of alpha.

9. References

- [1]-D.Thukaram, H.P.Khincha, and B.Ravikumar,"Harmonic Minimization in the Operation of Static VAR Compensators for Unbalance Reactive Power Compensation ", International Conference on Power System Technology, Singapore, November 2004.
- [2]-Lasszlo Gyugyi, "Power Electronic in Electric Utilities: Static Var Compensators ", proceeding of the IEEE, vol.76, No.4, April 1988.
- [3]-R.Gutman, J.J.Kean, M.Ea.Rahman, and O.Veraas, "Application and Operation of A Static VAR System on A Power System American Electric Power Experience", IEEE Transaction on Power Apparatus and System, vol, PAS-104, No.7, July 1985.
- [4]-Muzunoglu,"Harmonics and Voltage Stability Analysis in Power Systems Including Thyristor – Controlled Reactor", Sadhana Vol.30, part 1, February 2005, pp.57-67.
- [5]-Miller, T.J.E, "Reactive Power Control in Electric System", John Wiley and Sons Ltd, 1982.
- [6]-Leonard J.Bhmann and Robert H.Lasseter,"Equivalent Circuit for Frequency Response of A Static VAR Compensator", IEEE Transaction on Power Apparatus and System, vol, PWRS-1, No.4, November 1986.
- [7]- Leonard J.Bhmann and Robert H.Lasseter, "Harmonic Interaction in Thyristor Controlled Reactor Circuit", IEEE Transaction on Power Delivery, Vol.4, No.3, July 1989.
- [8]- E.Acha, M.Madrigal,"Power System Harmonic Computer Modeling and Analysis", John Wiley and Sons

Chichester 2002.

[9]-A.Semlyen, E.Acha, and J.Arrillaga,"Newton –Type Algorithms for the Harmonic phasor Analysis of Non-Linear Power Circuit Periodical Steady State With Special Reference to Magnetic Non-Linearities", IEEE Transaction on Power Delivery, Vol.3, No.3, July 1988.

[10]-J.Arrillaga, N.R.Watson,"Power System Harmonics", John Wiley and Sons, Chichester, 2004.

[11]-Stavros A.Papathanassiou,Michael P.Papadopoulos , "Harmonic Analysis in a Power System Wind Generation ",2004.

<http://www.powerit.rt.edu./AA/chapters/pdffiles/c1pdf.pdf>.

[12]-Task force on Harmonics Modeling and Simulation," Test Systems for Harmonics Modeling and Simulation" IEEE Transaction on Power Delivery, Vol.14, No.2, April 1999.

Brach type	Bus number		R(pu)	X(pu)	B(pu)
	From	to			
Line	1	2	0.01937	0.05916	0.05279
Line	2	3	0.04697	0.19794	0.04380
Line	3	4	0.06700	0.17099	0.03460
Line	4	5	0.01335	0.0209	0.01280
Line	1	5	0.05402	0.22300	0.04920
line	2	4	0.05810	0.17628	0.03740
line	2	5	0.09808	0.20615	0.05522
Trasf	5	6	0.0000	0.25020	0.00000
Trasf	4	7	0.0000	0.25020	0.00000
Line	6	9	0.09495	0.19887	0.0000
Line	6	10	0.12285	0.25575	0.0000
Line	6	11	0.06613	0.13024	0.0000
Line	7	8	0.03181	0.08448	0.0000
Line	7	12	0.01270	0.27033	0.0000
Line	8	9	0.08203	0.19202	0.0000
Line	10	11	0.22087	0.19985	0.0000
Line	11	12	0.17089	0.34795	0.0000

Table (1) transmission line parameter 50HZ system

Bus	Bus voltage(pu)	Angle (deg)	P Load (pu)	Q Load (pu)	Load impedance (Z _L)
2	1.0319	-0.7423	0.5	0.3	1.5660+0.9396i
3	0.9877	-2.2984	0.4	0.35	1.7539+10.962i
4	0.9967	-1.3805	0.6	0.15	1.5583+0.3896i
5	1.0157	-1.5712	0.35	0.15	2.4900+1.0671i
7	0.9827	-1.0010	0.3	0.2	2.2286+1.4857i
8	0.9763	-1.2216	0.2	0.12	3.5039+2.1024i
9	0.9934	-2.1166	0.32	0.1	2.8098+0.8781i
10	0.9313	-0.0452	0.6	0.4	0.3268+0.0504i
11	1.2242	-3.5670	0.45	0.35	1.3270+1.0321i
12	1.0441	-3.6170	0.35	0.2	2.3482+1.3418i

Table (2) fundamental load flow results

Busvoltage h	V ₁	V ₂	V ₃	V ₄	V ₅	V ₆	V ₇	V ₈	V ₉	V ₁₀	V ₁₁	V ₁₂
3	0.0117	0.0181	0.0883	0.0221	0.0180	0.0060	0.0109	0.0100	0.0080	0.0005	0.0045	0.0081
5	0.0018	0.0040	0.0212	0.0048	0.0037	0.0012	0.0023	0.0021	0.0017	0.0001	0.0009	0.0017
7	0.0008	0.0024	0.0140	0.0029	0.0021	0.0007	0.0014	0.0012	0.0010	0.0000	0.0005	0.0010
9	0.0002	0.0007	0.0046	0.0009	0.0006	0.0002	0.0004	0.0004	0.0003	0.0000	0.0001	0.0003
11	0.0001	0.0003	0.0027	0.0005	0.0003	0.0001	0.0002	0.0002	0.0001	0.0000	0.0001	0.0002
13	0.0001	0.0008	0.0070	0.0011	0.0006	0.0002	0.0005	0.0004	0.0003	0.0000	0.0002	0.0003
15	0.0000	0.0005	0.0050	0.0007	0.0004	0.0001	0.0003	0.0003	0.0002	0.0000	0.0001	0.0002
17	0.0000	0.0004	0.0048	0.0006	0.0003	0.0001	0.0003	0.0002	0.0002	0.0000	0.0001	0.0002
19	0.0000	0.0003	0.0036	0.0004	0.0002	0.0001	0.0002	0.0002	0.0001	0.0000	0.0001	0.0001
21	0.0000	0.0001	0.0021	0.0002	0.0001	0.0000	0.0001	0.0001	0.0001	0.0000	0.0000	0.0001
23	0.0000	0.0001	0.0017	0.0002	0.0001	0.0000	0.0001	0.0001	0.0000	0.0000	0.0000	0.0000
25	0.0000	0.0000	0.0003	0.0000	0.0000	0.0000	0.0000	0.0000	0.0000	0.0000	0.0000	0.0000
27	0.0000	0.0000	0.0002	0.0000	0.0000	0.0000	0.0000	0.0000	0.0000	0.0000	0.0000	0.0000
29	0.0000	0.0000	0.0006	0.0000	0.0000	0.0000	0.0000	0.0000	0.0000	0.0000	0.0000	0.0000

Table (3) harmonic bus voltages in per unit for α=110

Busvoltage h	I ₁₋₂	I ₁₋₅	I ₂₋₃	I ₂₋₄	I ₂₋₅	I ₃₋₄	I ₄₋₅	I ₆₋₉	I ₆₋₁₀	I ₆₋₁₁	I ₇₋₈	I ₇₋₁₂	I ₈₋₉	I ₁₀₋₁₁	I ₁₁₋₁₂	I _T
3	0.1018	0.0287	0.1479	0.0441	0.0374	0.0932	0.1425	0.0139	0.0060	0.0120	0.0398	0.0148	0.0161	0.0069	0.0083	0.23
5	0.0136	0.0038	0.0216	0.0066	0.0057	0.0216	0.0182	0.0017	0.0013	0.0018	0.0055	0.0027	0.0030	0.0009	0.0013	0.07
7	0.0058	0.0015	0.0103	0.0033	0.0029	0.0141	0.0076	0.0010	0.0007	0.0009	0.0025	0.0015	0.0014	0.0004	0.0007	0.01
9	0.0013	0.0003	0.0026	0.0009	0.0008	0.0046	0.0017	0.0009	0.0002	0.0002	0.0006	0.0004	0.0004	0.0001	0.0002	0.00
11	0.0006	0.0001	0.0013	0.0004	0.0004	0.0027	0.0008	0.0001	0.0001	0.0001	0.0003	0.0002	0.0002	0.0000	0.0001	0.00
13	0.0010	0.0002	0.0028	0.0009	0.0008	0.0070	0.0016	0.0003	0.0002	0.0002	0.0006	0.0005	0.0005	0.0001	0.0002	0.00
15	0.0006	0.0001	0.0018	0.0006	0.0005	0.0051	0.0009	0.0002	0.0001	0.0001	0.0004	0.0003	0.0003	0.0000	0.0001	0.01
17	0.0004	0.0001	0.0015	0.0005	0.0004	0.0048	0.0007	0.0001	0.0001	0.0001	0.0003	0.0003	0.0003	0.0000	0.0001	0.00
19	0.0002	0.0000	0.0010	0.0003	0.0003	0.0036	0.0005	0.0001	0.0001	0.0001	0.0002	0.0002	0.0002	0.0000	0.0001	0.00
21	0.0001	0.0000	0.0005	0.0002	0.0001	0.0021	0.0003	0.0000	0.0000	0.0000	0.0001	0.0001	0.0001	0.0000	0.0000	0.00
23	0.0001	0.0000	0.0004	0.0001	0.0001	0.0017	0.0002	0.0000	0.0000	0.0000	0.0001	0.0001	0.0001	0.0000	0.0000	0.00
25	0.0000	0.0000	0.0001	0.0000	0.0000	0.0003	0.0000	0.0000	0.0000	0.0000	0.0000	0.0000	0.0000	0.0000	0.0000	0.00
27	0.0000	0.0000	0.0000	0.0000	0.0000	0.0002	0.0000	0.0000	0.0000	0.0000	0.0000	0.0000	0.0000	0.0000	0.0000	0.00
29	0.0000	0.0000	0.0001	0.0000	0.0000	0.0006	0.0001	0.0000	0.0000	0.0000	0.0000	0.0000	0.0000	0.0000	0.0000	0.00

Table (4) harmonic lines current in per unit for α=110

Busvoltage h	V ₁	V ₂	V ₃	V ₄	V ₅	V ₆	V ₇	V ₈	V ₉	V ₁₀	V ₁₁	V ₁₂
3	0.0043	0.0066	0.0324	0.0081	0.0066	0.0022	0.0040	0.0037	0.0030	0.0002	0.0016	0.0030
5	0.0005	0.0012	0.0064	0.0014	0.0011	0.0004	0.0007	0.0006	0.0005	0.0000	0.0003	0.0005
7	0.0001	0.0004	0.0026	0.0005	0.0004	0.0001	0.0003	0.0002	0.0002	0.0000	0.0001	0.0002
9	0.0002	0.0010	0.0069	0.0013	0.0009	0.0003	0.0006	0.0005	0.0004	0.0000	0.0002	0.0004
11	0.0001	0.0006	0.0044	0.0007	0.0005	0.0002	0.0003	0.0003	0.0002	0.0000	0.0001	0.0002
13	0.0000	0.0003	0.0030	0.0005	0.0003	0.0001	0.0002	0.0002	0.0001	0.0000	0.0001	0.0001
15	0.0000	0.0002	0.0022	0.0003	0.0002	0.0001	0.0001	0.0001	0.0001	0.0000	0.0000	0.0001
17	0.0000	0.0000	0.0005	0.0001	0.0000	0.0000	0.0000	0.0000	0.0000	0.0000	0.0000	0.0000
19	0.0000	0.0000	0.0004	0.0000	0.0000	0.0000	0.0000	0.0000	0.0000	0.0000	0.0000	0.0000
21	0.0000	0.0001	0.0010	0.0001	0.0000	0.0000	0.0000	0.0000	0.0000	0.0000	0.0000	0.0000
23	0.0000	0.0000	0.0008	0.0001	0.0000	0.0000	0.0000	0.0000	0.0000	0.0000	0.0000	0.0000
25	0.0000	0.0000	0.0006	0.0001	0.0000	0.0000	0.0000	0.0000	0.0000	0.0000	0.0000	0.0000
27	0.0000	0.0000	0.0005	0.0000	0.0000	0.0000	0.0000	0.0000	0.0000	0.0000	0.0000	0.0000
29	0.0000	0.0000	0.0001	0.0000	0.0000	0.0000	0.0000	0.0000	0.0000	0.0000	0.0000	0.0000

Table (5) harmonic bus voltages in per unit for α=120

Busvoltage h	I ₁₋₂	I ₁₋₅	I ₂₋₃	I ₂₋₄	I ₂₋₅	I ₃₋₄	I ₄₋₅	I ₆₋₉	I ₆₋₁₀	I ₆₋₁₁	I ₇₋₈	I ₇₋₁₂	I ₈₋₉	I ₁₀₋₁₁	I ₁₁₋₁₂	I _{TCR}
3	0.0374	0.0105	0.0543	0.0162	0.0137	0.0342	0.0523	0.0051	0.0022	0.0044	0.0146	0.0054	0.0059	0.0025	0.0031	0.0733
5	0.0041	0.0011	0.0065	0.0020	0.0017	0.0065	0.0054	0.0005	0.0004	0.0005	0.0016	0.0008	0.0009	0.0003	0.0004	0.0147
7	0.0011	0.0003	0.0019	0.0006	0.0005	0.0026	0.0014	0.0002	0.0001	0.0002	0.0005	0.0003	0.0003	0.0001	0.0001	0.0051
9	0.0020	0.0005	0.0040	0.0013	0.0012	0.0069	0.0026	0.0014	0.0003	0.0004	0.0009	0.0006	0.0006	0.0001	0.0003	0.0080
11	0.0009	0.0002	0.0021	0.0007	0.0006	0.0044	0.0013	0.0002	0.0002	0.0002	0.0005	0.0004	0.0003	0.0001	0.0001	0.0077
13	0.0004	0.0001	0.0012	0.0004	0.0004	0.0030	0.0007	0.0001	0.0001	0.0001	0.0003	0.0002	0.0002	0.0000	0.0001	0.0057
15	0.0002	0.0001	0.0008	0.0002	0.0002	0.0022	0.0004	0.0001	0.0001	0.0001	0.0002	0.0001	0.0001	0.0000	0.0001	0.0029
17	0.0000	0.0000	0.0002	0.0001	0.0000	0.0005	0.0001	0.0000	0.0000	0.0000	0.0000	0.0000	0.0000	0.0000	0.0000	0.0011
19	0.0000	0.0000	0.0001	0.0000	0.0000	0.0004	0.0000	0.0000	0.0000	0.0000	0.0000	0.0000	0.0000	0.0000	0.0000	0.0008
21	0.0001	0.0000	0.0003	0.0001	0.0001	0.0010	0.0001	0.0000	0.0000	0.0000	0.0001	0.0000	0.0000	0.0000	0.0000	0.0014
23	0.0000	0.0000	0.0002	0.0000	0.0000	0.0008	0.0001	0.0000	0.0000	0.0000	0.0000	0.0000	0.0000	0.0000	0.0000	0.0018
25	0.0000	0.0000	0.0001	0.0000	0.0000	0.0006	0.0001	0.0000	0.0000	0.0000	0.0000	0.0000	0.0000	0.0000	0.0000	0.0015
27	0.0000	0.0000	0.0001	0.0000	0.0000	0.0005	0.0000	0.0000	0.0000	0.0000	0.0000	0.0000	0.0000	0.0000	0.0000	0.0009
29	0.0000	0.0000	0.0000	0.0000	0.0000	0.0001	0.0000	0.0000	0.0000	0.0000	0.0000	0.0000	0.0000	0.0000	0.0000	0.0004

Table (6) harmonic lines current in per unit for α=120

Busvoltage h	V ₁	V ₂	V ₃	V ₄	V ₅	V ₆	V ₇	V ₈	V ₉	V ₁₀	V ₁₁	V ₁₂
3	0.0010	0.0016	0.0078	0.0020	0.0016	0.0005	0.0010	0.0009	0.0007	0.00004	0.0004	0.0007
5	0.0006	0.0014	0.0076	0.0017	0.0013	0.0004	0.0008	0.0008	0.0006	0.00002	0.0003	0.0006
7	0.0002	0.0006	0.0033	0.0007	0.0005	0.0002	0.0003	0.0003	0.0002	0.0000	0.0001	0.0002
9	0.0001	0.0004	0.0026	0.0005	0.0003	0.0001	0.0002	0.0002	0.0002	0.0000	0.0001	0.0002
11	0.0000	0.0001	0.0005	0.0001	0.0001	0.0000	0.0000	0.0000	0.0000	0.0000	0.0000	0.0000
13	0.0000	0.0000	0.0003	0.0001	0.0000	0.0000	0.0000	0.0000	0.0000	0.0000	0.0000	0.0000
15	0.0000	0.0001	0.0007	0.0001	0.0001	0.0000	0.0000	0.0000	0.0000	0.0000	0.0000	0.0000
17	0.0000	0.0001	0.0007	0.0001	0.0000	0.0000	0.0000	0.0000	0.0000	0.0000	0.0000	0.0000
19	0.0000	0.0000	0.0005	0.0001	0.0000	0.0000	0.0000	0.0000	0.0000	0.0000	0.0000	0.0000
21	0.0000	0.0000	0.0004	0.0000	0.0000	0.0000	0.0000	0.0000	0.0000	0.0000	0.0000	0.0000
23	0.0000	0.0000	0.0001	0.0000	0.0000	0.0000	0.0000	0.0000	0.0000	0.0000	0.0000	0.0000
25	0.0000	0.0000	0.0001	0.0000	0.0000	0.0000	0.0000	0.0000	0.0000	0.0000	0.0000	0.0000
27	0.0000	0.0000	0.0002	0.0000	0.0000	0.0000	0.0000	0.0000	0.0000	0.0000	0.0000	0.0000
29	0.0000	0.0000	0.0002	0.0000	0.0000	0.0000	0.0000	0.0000	0.0000	0.0000	0.0000	0.0000

Table (7) harmonic bus voltages in per unit for $\alpha=150$

Busvoltage h	I ₁₋₂	I ₁₋₅	I ₂₋₃	I ₂₋₄	I ₂₋₅	I ₃₋₄	I ₄₋₅	I ₆₋₉	I ₆₋₁₀	I ₆₋₁₁	I ₇₋₈	I ₇₋₁₂	I ₈₋₉	I ₁₀₋₁₁	I ₁₁₋₁₂	I _{TCR}
3	0.0090	0.0025	0.0131	0.0039	0.0033	0.0082	0.0126	0.0012	0.0005	0.0011	0.0035	0.0013	0.0014	0.0006	0.0007	0.0054
5	0.0049	0.0013	0.0077	0.0024	0.0020	0.0077	0.0065	0.0006	0.0004	0.0006	0.0019	0.0010	0.0011	0.0003	0.0005	0.0045
7	0.0014	0.0004	0.0024	0.0008	0.0007	0.0033	0.0018	0.0002	0.0001	0.0002	0.0006	0.0003	0.0003	0.0001	0.0002	0.0021
9	0.0007	0.0002	0.0015	0.0005	0.0004	0.0026	0.0010	0.0005	0.0001	0.0001	0.0004	0.0002	0.0002	0.0001	0.0001	0.0002
11	0.0001	0.0000	0.0002	0.0001	0.0001	0.0005	0.0001	0.0000	0.00001	0.0000	0.0001	0.0000	0.0000	0.0000	0.0000	0.0007
13	0.0000	0.0000	0.0001	0.0000	0.0000	0.0003	0.0001	0.0000	0.00001	0.0000	0.0000	0.0000	0.0000	0.0000	0.0000	0.0007
15	0.0001	0.0000	0.0003	0.0001	0.0001	0.0007	0.0001	0.0000	0.00002	0.0000	0.0001	0.0000	0.0000	0.0000	0.00002	0.0001
17	0.0001	0.0000	0.0002	0.0001	0.0001	0.0007	0.0001	0.0000	0.00002	0.0000	0.0000	0.0000	0.0000	0.0000	0.00002	0.0004
19	0.0000	0.0000	0.0001	0.0000	0.0000	0.0005	0.0001	0.0000	0.0094	0.0000	0.0000	0.0000	0.0000	0.0000	0.0000	0.0003
21	0.0000	0.0000	0.0001	0.0000	0.0000	0.0004	0.0000	0.0000	0.0000	0.0000	0.0000	0.0000	0.0000	0.0000	0.0000	0.0000
23	0.0000	0.0000	0.0000	0.0000	0.0000	0.0001	0.0000	0.0000	0.0000	0.0000	0.0000	0.0000	0.0000	0.0003	0.0000	0.0002
25	0.0000	0.0000	0.0000	0.0000	0.0000	0.0001	0.0000	0.0000	0.0000	0.0000	0.0000	0.0000	0.0000	0.0000	0.0000	0.0002
27	0.0000	0.0000	0.0000	0.0000	0.0000	0.0002	0.0000	0.0000	0.0000	0.0000	0.0000	0.0000	0.0000	0.0000	0.0000	0.0000
29	0.0000	0.0000	0.0000	0.0000	0.0000	0.0002	0.0000	0.0000	0.0000	0.0000	0.0000	0.0000	0.0000	0.0000	0.0000	0.0001

Table (8) harmonic lines current in per unit for $\alpha=150$

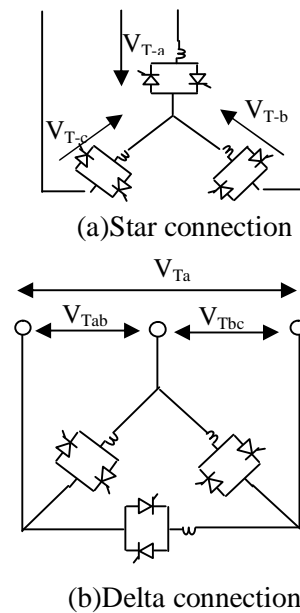
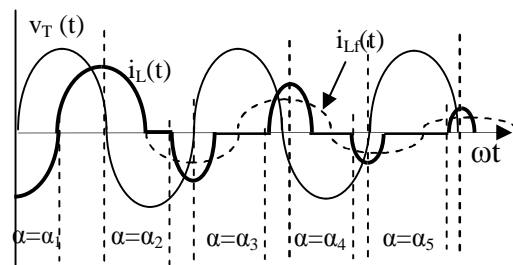
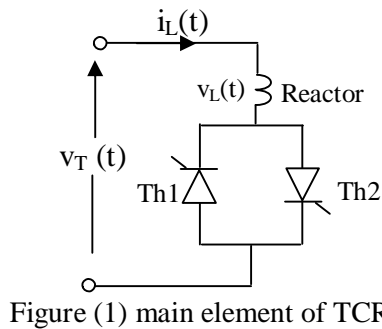

Figure (3) three phase TCR arrangement

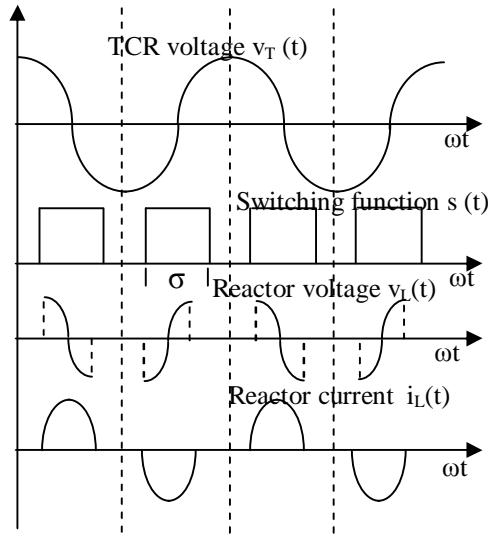

Figure (4) TCR ideal operation

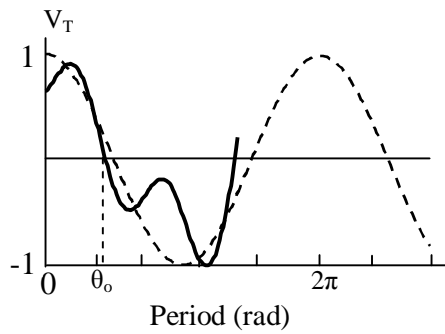

Figure (5) voltage zero crossing

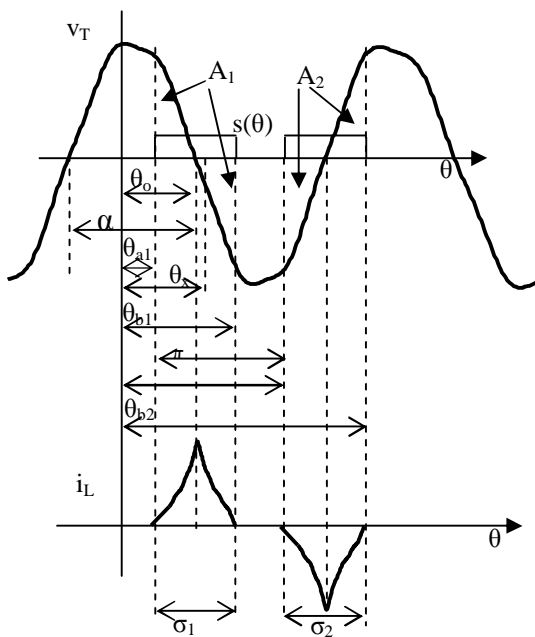

Figure (6) TCR operation

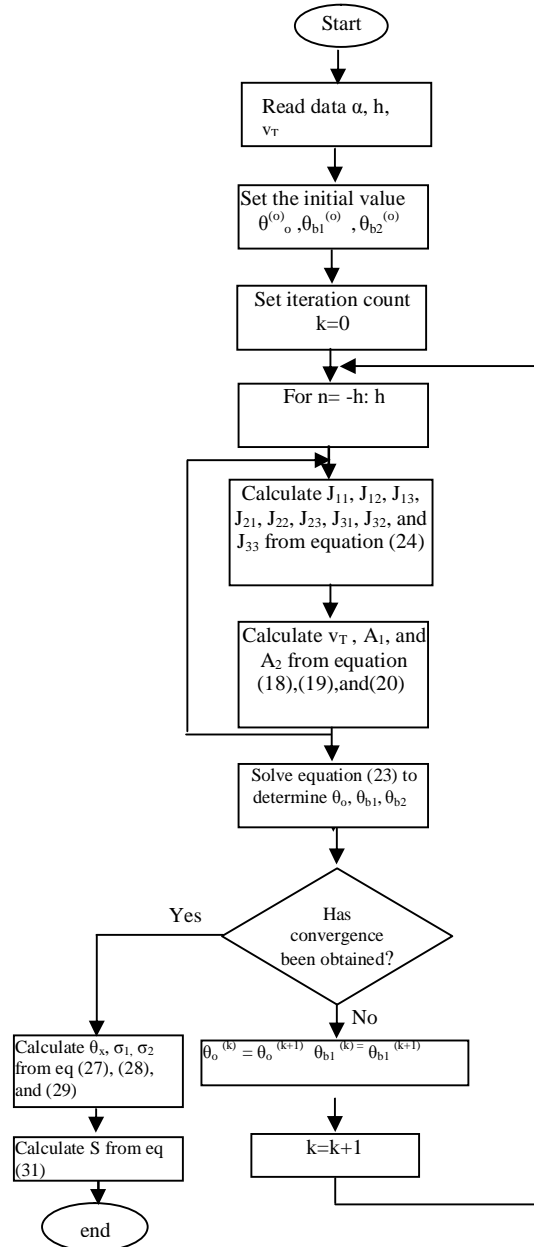

Figure (7) flowchart used to determine the switching function S.

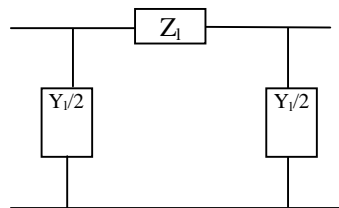

Figure (8) nominal π model of transmission line

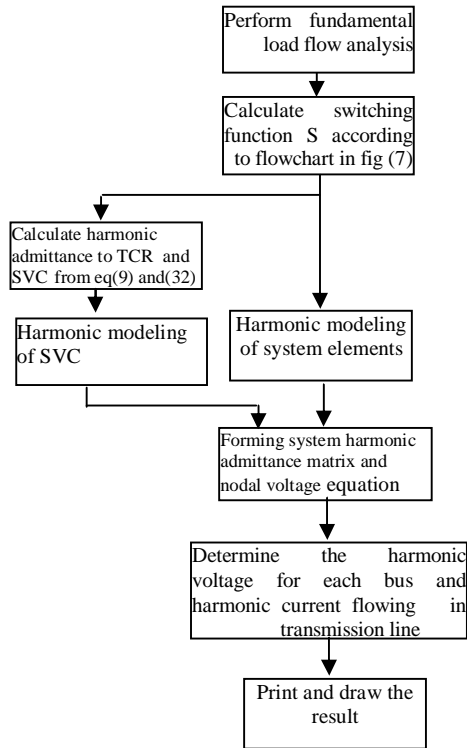

Figure (9) block diagram of harmonic analysis in system include SVC.

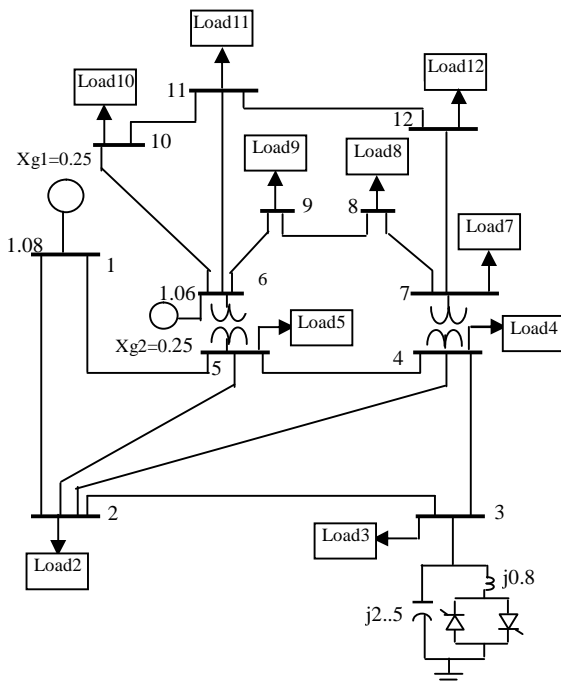

Figure (10) one line diagram of system under study

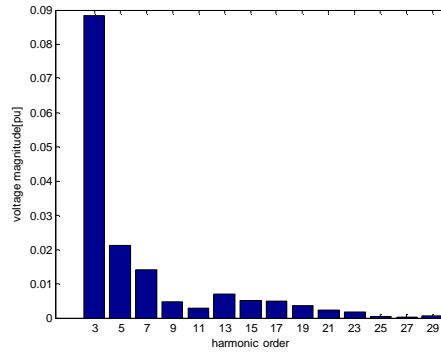

Figure (11) harmonic voltage spectrum at bus 3 for $\alpha=110$

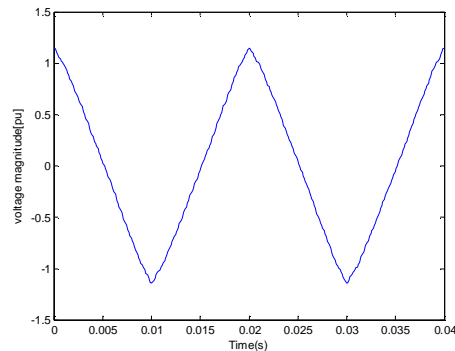

Figure (12) voltage waveform at bus 3 for $\alpha=110$

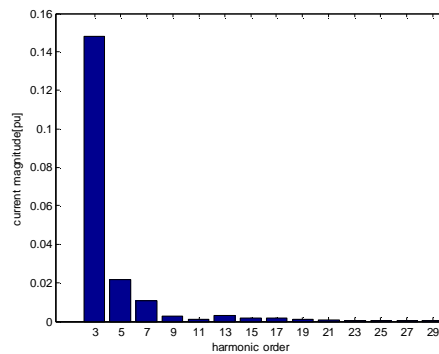

Figure (13) harmonic current spectrum in line 2-3 for $\alpha=110$

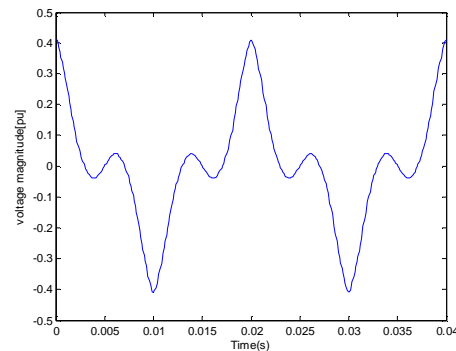

Figure (14) current waveform in line 2-3 for $\alpha=110$

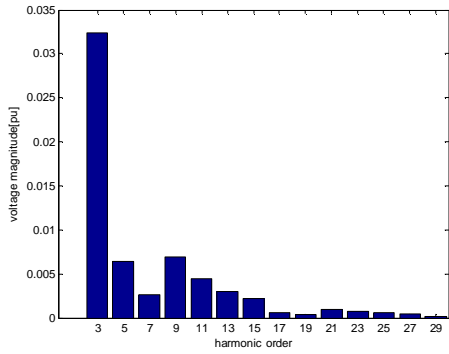

Figure (15) harmonic voltage spectrum at bus 3 for $\alpha=120$

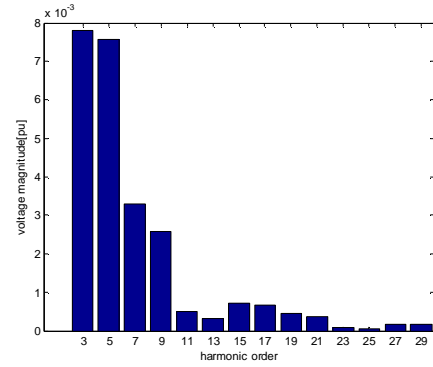

Figure (19) harmonic voltage spectrum at bus 3 for $\alpha=150$

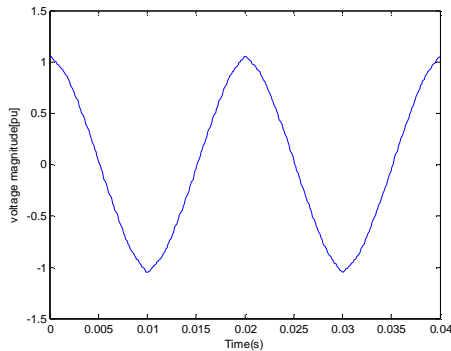
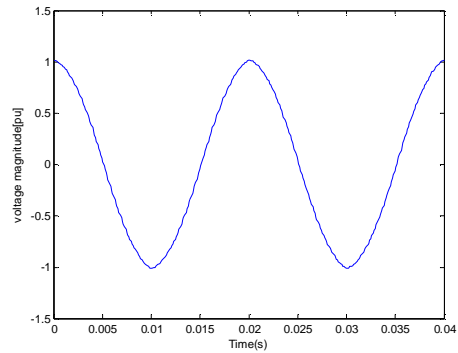

Figure (16) voltage waveform at bus 3 for $\alpha=120$



Figure(20)voltage wave at bus 3 for $\alpha=150$

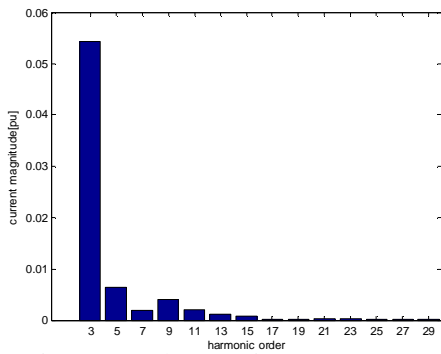

Figure (17) harmonic current spectrum in line 2-3 for $\alpha=120$

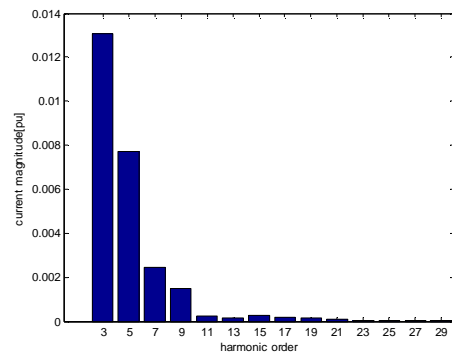

Figure (21) harmonic current spectrum in line2-3 for $\alpha=150$

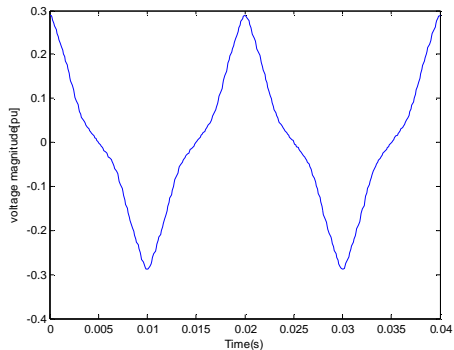

Figure (18) current waveform in line2-3 for $\alpha=120$

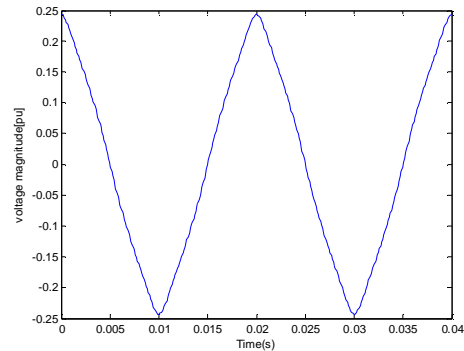

Figure (22) current waveform in line2-3 for $\alpha=150$