

# Distribution Power System Protected by Petersen Coil: Detection of Single Line to Ground Fault Using Deep Learning

**Qusay Muayad Mohammed**

[Qusay.20enp63@student.uomosul.edu.iq](mailto:Qusay.20enp63@student.uomosul.edu.iq)

**Abdulghani Abdulrazaq Al-Taei**

[Drabdulghani18@uomosul.edu.iq](mailto:Drabdulghani18@uomosul.edu.iq)

Electrical Engineering Department, Collage of Engineering, University of Mosul, Mosul, Iraq

Received: December 30<sup>th</sup>, 2022 Received in revised form: February 24<sup>th</sup>, 2023 Accepted: March 2<sup>nd</sup>, 2023

## ABSTRACT

*In all fault detection techniques, fault signal feature extraction is crucial and challenging. Convolutional neural network and continuous wavelet transform (CNN)-the based technique of SLGF detection in distribution power system protected by Petersen coil proposed in this paper. By using the CWT on the zero-sequence current signals of the faulty feeder and healthy feeders, time-frequency RGB scale images acquired. A few RGB scale pictures under different types of faults circumstances, which will extract characteristics of RGB scale image adaptively, trained that which is CNN. A trained CNN could extract features and detect faulty feeder simultaneously. The distribution power system protected by Petersen coil simulated in MATLAB simulated and record the Zero Sequence Current ZSC and analyzed it by Orange big mining tool. The efficacy and the performance the suggested method for detecting faulty feeders are compared and confirmed under various faults scenarios, two methods for identifying faulty feeders on conventional machine learning and artificial feature extraction for comparison, concluded that The CNN best to detected the fault in different condition, for Test 1 and Test 2 were classification accuracy 100%, and Test 3 was 99.5%, and Test 4 was 70.9%.*

## Keywords:

*Single Line to Ground Fault (SLGF); faulty feeder detection; Petersen coil; convolutional neural network; wavelet transform*

*This is an open access article under the CC BY 4.0 license (<http://creativecommons.org/licenses/by/4.0/>).*

*<https://rengj.mosuljournals.com>*

*Email: [alrafidain\\_engjournal1@uomosul.edu.iq](mailto:alrafidain_engjournal1@uomosul.edu.iq)*

## 1. INTRODUCTION

When a single-line-to-ground fault (SLGF) happened in a distribution system that used resonant grounding protected by Petersen coil, given that the fault current is modest and the line-to-line voltage is still symmetrical, the distribution system is permitted to continue functioning for a 1 ~ 2 hours in accordance with technical standards [1].

Recently, several protective methods and schemes proposals for SLGF exist [2], which are categorized into three groups: steady state signals protection methods, schemes for transient state protection, Signal-based protection system, information fusion, and three technology-based protection. The combination of numerous techniques has become possible with the advancement of information fusion technology. In [3] suggested using genetic neural networks to

implement detected for faulty feeders. In [4] proposed an SFGF protection method without setting a threshold.

Techniques based on the wavelet transform and the Bayesian selection methodology is suggested for identifying the faulty feeder [5].

Small current grounding systems use the artificial neural network (ANN) approach to choosing fault lines. The classification results are generated by execution of the ANN model to discover the Testing of incorrect data and the classification rules between the input and target data [6].

## 2. THE THEORETICAL BASES

When a single fault to ground happened, transient current in the zero sequence waveform

characterized between fault feeder and health feeders, the transient ground current

$i_d$  Comprised of transient inductive current  $i_L$  and transient capacitance current  $i_C$  by the equation(1)

$$i_d = i_L + i_C = (I_{Cm} - I_{Lm}) \cos(\omega t + \varphi) + I_{Lm} \cos\varphi e^{-\frac{t}{\tau_L}} + I_{Cm} \left( \frac{\omega_f}{\omega} \sin\varphi \sin\omega_f t - \cos\varphi \sin\omega_f t \right) e^{-\frac{t}{\tau_C}} \quad (1)$$

where  $I_{Lm}$  and  $I_{Cm}$  Capacitive current, power frequency is  $\omega$ , initial phase angle of phase voltage at fault time is  $\varphi$ , angular frequency of free oscillation component is  $\omega_f$  where oscillation frequency defined as number of cycles/oscillation per second,  $\tau_L$ ,  $\tau_C$  is the time constant of inductance and capacitance loops [7].

**2.1 Continuous Wavelet Transform**

Wavelet transformers considered a time-frequency analysis method, which is classified as discrete wavelet transform DWT and continuous wavelet transform CWT [8]; The signal is split into many parts for many different frequency components in mother wavelet transform, where it can scale high-frequency resolution and low time resolution in the low frequencies and high time resolution and low-frequency resolution in the high frequency [9].

The Fourier transform  $\psi(\omega)$  that satisfied the condition:

$$C_\psi = \int_R \frac{|\psi(\omega)|^2}{|\omega|} d\omega < \infty \quad (2)$$

And  $\psi(t)$  is defined as the mother wavelet function where wavelet defined as a wave with limited duration with average value of zero and nonzero norm, and the continuous wavelet function given by

$$\psi_{a,b}(t) = \frac{1}{\sqrt{a}} \psi\left(\frac{t-b}{a}\right) \quad a, b \in R, a \neq 0 \quad (3)$$

Where  $a$  is the scale and  $b$  is the translation parameter.

For signal  $x(t)$  is defined as equation (4) continuous wavelet transform

$$CWT_x(a, b) = \frac{1}{\sqrt{a}} \int_{-\infty}^{\infty} \psi\left(\frac{t-b}{a}\right) x(t) dt \quad (4)$$

Used Analytic Morlet that has equal variance time and frequency

The Fourier transform of the Morlet wavelet is given by

$$\psi(f) = \pi^{1/4} \sqrt{2} e^{-(1/2)(2\pi f - 2\pi f_0)^2} \quad (5)$$

Which is a Gaussian function with a displacement along the frequency axis of  $f_0$ . That is typically the characteristic frequency of the analytical Morlet wavelet rather than the pass band frequency is chosen to be the center frequency of the Gaussian spectrum, which we previously used for the wavelet on the Mexican hat [10].

**2.2 Convolution Neural Network**

The C layer's convolution operation is defined

$$x_j^l = f\left(\sum_{i \in M_j} x_i^{l-1} \cdot K_{ij}^l + b_j^l\right) \quad (6)$$

$l$  is the number of layers, The kernel  $K$ ,  $b$  is biased, and  $x_j^{l-1}$  is the output of layer  $l-1$   $x_j^{l-1}$  is input layer  $l$ ; for activation function  $f$ ,  $M_j$  is the input feature set.

To prevent over-fitting, we used  $S$  (sub-sampling layer)  $S$  as an equation  
Is

$$x_j^l = f\left(a_j^l \cdot \max_{i \in M_j} (x_i^{l-1}) + b_j^l\right),$$

$$x_j^l = f\left(a_j^l \cdot \frac{1}{kt} \sum_{i \in M_j} x_i^{l-1} + b_j^l\right) \quad (7)$$

Where  $a$ ,  $b$  are bias and  $k$ ,  $t$  are dimensional of the pooling matrix. First, the output features pictures from the preceding layer are extended into the column vectors one by one, then stacked to create a single column eigenvector for CNN full-connection layer.

The eigenvector is mapped equation [11],[12].

$$y_k = f(\omega_k x + b_k) \quad (8)$$

In Fig.1 showed CNN structure

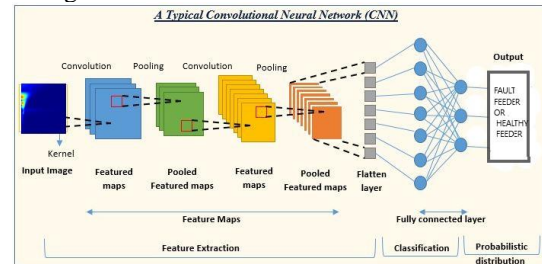

Fig.1 CNN Structure

**2.3 Feature Extraction**

For feature extraction approach in machine and deep learning engineering, the correlation coefficient to similarity distinguish of images to correlation tow points  $p$  and  $q$  with  $k$  dimensions is calculation

$$\text{correlation}(p_k, q_k) = \sum_{k=1}^n \frac{\text{cov}(p_k, q_k)}{\text{std}(p_k) \cdot \text{std}(q_k)} \quad (9)$$

Where

$$\text{cov}(p_k, q_k) = \frac{1}{n} \sum_{k=1}^n (p_k - \bar{p}) \cdot (q_k - \bar{q}) \quad (10)$$

$$\text{std}(p_k) = \frac{1}{n} \sum_{k=1}^n (p_k - \bar{p})^2 \quad (11)$$

Where

$$\tilde{p} = \frac{1}{n} \sum_{k=1}^n (p_k) \quad (12)$$

Where cov is a covariance of variables, Std is a standard deviation, and calculated Euclidean distance to distinguish the difference of amplitude two images.

$$\begin{aligned} & Euclidean(p_k, q_k) \\ &= \sqrt{\sum_{k=1}^n (p_k - q_k)^2} \end{aligned} \quad (13)$$

For feature extraction the images content color, texture, shape, position, and dominate edges of images items and regions [13], [14], [15]. For find similarity of two images by taken points for pixels at images to distinguish by correlation coefficient of points p and q with k dimensions, and to calculate distance by Euclidean distance to describes the difference of points at images [16],[17].

#### 2.4 SVM (Support Vector Machine)

Support vector machines (SVMs) are a collection of supervised learning methods used for regression and classification tasks. Its primary goal is to achieve high predictive accuracy while preventing overfitting to the data. This is accomplished by utilizing machine-learning theory, which involves employing a linear function in a feature space with multiple dimensions. The SVM is trained using an optimization process. Theory based learning algorithm that incorporates a learning bias [18].

#### 2.5 Adaboost

The Boosting technique known as the AdaBoost algorithm, also known as Adaptive Boosting, is used as an Ensemble Method in machine learning. For supervised learning, boosting is used to lower bias and variance. The weights are redistributed to each instance, with higher weights being given to instances that were incorrectly classified, hence the name "adaptive boosting [19].

#### 2.6 Faulty Feeders Detection Based on SVM and Adaboost

classification outcomes may differ when the same features are mixed with several classifiers. SVM and Adaboost classifiers are frequently employed in different classification or recognition tasks. Adaboost has excellent high classification accuracy and flexibility. Structural risk minimization and statistical learning theory are the foundations of the machine learning technique known as SVM, which has a distinct benefit in tackling problems with few samples,

nonlinear behavior, or high dimensions. It is appropriate for both defective and accurate recognition [20].

### 3. THE PROPOSED METHODOLOGY

The proposed methodology is to take the signals of the zero-sequence currents for faulty feeder and healthy feeders, convert them by continuous wavelet transform into scalogram form, collect the images, and discover the features extraction by the convolutional neural network technique, then identify the faulty feeder as explained in Flowchart in Fig.2 .

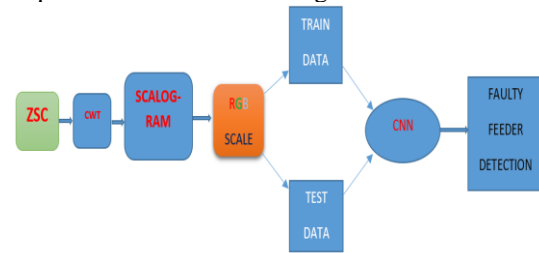

Fig.2 Flowchart of Detection Method SLGF

The distribution power system protected by the Petersen coil model in Fig.3 is simulated by Matlab simulation to generate and record ZSC for faulty feeders and healthy feeders for collected samples for training and Testing in CNN.

Table 1: Parameters of Power System

Three Phase Source	33Kv , 50 Hz
Transformer ( $\Delta$ -Y)	25MVA , 33/11kV , 50 Hz
Length of Feeder1 (Over-Head)	15 km
Length of Feeder 2 (Cable)	10 km
Length of Feeder 3 (Cable)	5 km
Load at Feeder 1	6 MVA
Load at Feeder 2	4.5 MVA
Load at Feeder 3	3 MVA
Petersen Coil Inductance at full compensated	0.6802 H

In Table 1, show the parameters of distribution power system earthed by Petersen Coil.

Table 2: Parameters of Lines

No. of Feeder	Resistance ( $\Omega$ /km)	Inductance (mH/km)	Capacitance (F/km)
Feeder 1	0.13728	1.998	9.39654e-9
Feeder 2	0.5125	1.24	0.3216e-6
Feeder 3	0.5125	1.24	0.3216e-6

In Table 2, show the parameters of lines.

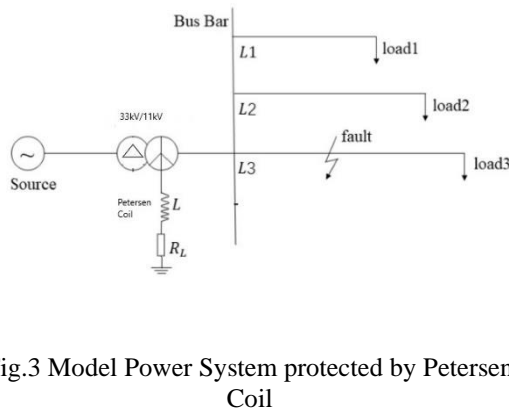

Fig.3 Model Power System protected by Petersen Coil

4. RESULTS AND DISCUSSIONS

This paper is proposed a model for a distribution power system that protected by Petersen coil. Four Tests have been done to detect single line to ground fault, and detected faulty feeder. The samples have been taken by making a fault by steps (1% from feeder length each step). Then, the Samples is recorded zero sequences current ZSC from time when initial fault happened during the first second of the fault, for each feeder to maked the samples, then taken the continuous wavelet transform by analytic Morlet (Gabor) type to obtained the Scalogram as samples, and collect the images to classified by convolution neural network, to normalized the signals, that trained by SqueezeNet [21]. Adaboost and support vector machine SVM for comparison results, analytic the result by Orange Big Mining OBM and obtain confusion matrix,

Confusion matrix is analyzed the results parameters of confusion matrix is showed in Table 4. Where TP: True Positive, FP: False Positive, FN: False Negative, TN: True Negative

		Actual Value	
		Positive (Class A)	Negative (Class B)
Predicted Value	Positive (Class A)	True Positives (TP)	False Positives (FP)
	Negative (Class B)	False Negatives (FN)	True Negatives (TN)

Fig.4 Confusion matrix

Table 3: Parameters of Confusion Matrix

Metric Name	Formula from Confusion Matrix
Accuracy (Classification Accuracy) (CA)	$(TP+TN)/(TP+TN+FP+FN)$
Precision	$TP/(TP+FP)$
Recall, Sensitivity	$TP/(TP+FN)$
Specificity	$TN/(TN+FP)$
F1-Score	$(2*precision*recall)/(precision+recall)$

Where true positive (TP), a Test result that correctly indicates the presence of characteristic. True negative (TN), a Test result that correctly indicates the absence of characteristic. False positive (FP), a Test result which wrongly indicates that a particular attribute is present. False negative (FN), a Test result which wrongly indicates that a particular attribute is absent, AUC is Area Under ROC Curve, ROC is (receiver operating characteristic curve) is a graph showing the performance of a classification model at all classification thresholds [22].

The parameters of CNN are cross-validation 5 fold,100 hidden layers, ReLu activation, ADAM solver, Regulations a = 0.001, the maximum number of iterations is 200, and parameters of Adaboost, the number of estimation is 50, the learning rate is 1.0000. And the parameters of SVM, the cost is 1, regression loss epsilon is 0.1, the kernel is RBF, numerical tolerance is 0.001, and the iteration limit is 100.

In the first Test to discriminate and detect the different faulty feeders in the model, the Petersen coil compensated degree was 100%, and fault resistance ( $R_f$ ) was 1 ohm with 100 images of positive and 200 images of negative. After training, each method classified the faulty feeder into different feeders.

In the second Test, the Petersen coil compensated degree for detecting by changing resistance faults in feeder 1 was 100%. The fault resistance values was 1,100 and 1000 ohms. The Test included 100 positive images and 200 negative images. After training, each method detected the faulty feeder.

In the third Test to discriminate and detect the compensated degree of Petersen coil of faulty feeder in feeder1 with resistance fault 1 ohm was the degree 90%,100%, and 110%, with 100 images of positive and 200 negative. In the fourth Test to discriminate and detect the healthy feeders and faulty feeders, in feeder 1 with 100% compensated degree and fault

resistance 1 ohm, With 100 images of positive and 200 negative.

Table 4: Scores of Test 1

Scores					
Model	AUC	CA	F1	Precision	Recall
SVM	1.0	1.0	1.0	1.0	1.0
CNN	1.0	1.0	1.0	1.0	1.0
AdaBoost	1.0	1.0	1.0	1.0	1.0

The Table 4 explained the Classification Accuracy CA of all classification algorithm detected the fault with 100% accuracy, because the high variance between images features for Test 1.

Confusion matrix for CNN (showing proportion of predicted)				
		Predicted		
		SLGF_100_1_10HM	SLGF_100_2_10HM	SLGF_100_3_10HM
Actual	SLGF_100_1_10HM	100.0 %	0.0 %	0.0 %
	SLGF_100_2_10HM	0.0 %	100.0 %	0.0 %
	SLGF_100_3_10HM	0.0 %	0.0 %	100.0 %

Fig.5 Confusion Matrix for CNN of Test 1

In Fig. 5 explained in Confusion matrix for CNN that the single line to ground fault at 100% Petersen coil compensated at fault resistance 1 Ohm for each feeder-detected accuracy 100%.

Confusion matrix for SVM (showing proportion of predicted)				
		Predicted		
		SLGF_100_1_10HM	SLGF_100_2_10HM	SLGF_100_3_10HM
Actual	SLGF_100_1_10HM	100.0 %	0.0 %	0.0 %
	SLGF_100_2_10HM	0.0 %	100.0 %	0.0 %
	SLGF_100_3_10HM	0.0 %	0.0 %	100.0 %

Fig.6 Confusion Matrix for SVM of Test 1

In Fig. 6 explained in Confusion matrix for SVM that the single line to ground fault at 100% Petersen coil compensated at fault resistance 1 Ohm for each feeder-detected accuracy 100%.

Confusion matrix for AdaBoost (showing proportion of predicted)				
		Predicted		
		SLGF_100_1_10HM	SLGF_100_2_10HM	SLGF_100_3_10HM
Actual	SLGF_100_1_10HM	100.0 %	0.0 %	0.0 %
	SLGF_100_2_10HM	0.0 %	100.0 %	0.0 %
	SLGF_100_3_10HM	0.0 %	0.0 %	100.0 %

Fig.7 Confusion Matrix for Adaboost of Test 1

In Fig. 7 explained in Confusion matrix for Adaboost that the single line to ground fault at 100% Petersen coil compensated at fault resistance 1 Ohm for each feeder-detected accuracy 100%.

Table 5: Scores of Test 2

Scores					
Model	AUC	CA	F1	Precision	Recall
SVM	1.0	1.0	1.0	1.0	1.0
CNN	1.0	1.0	1.0	1.0	1.0
AdaBoost	1.0	1.0	1.0	1.0	1.0

The Table 5 explained the CA of all classification algorithm detected the fault with 100% accuracy, because the high variance between images features for Test 2.

Confusion matrix for CNN (showing proportion of predicted)				
		Predicted		
		SLGF_100_1_1000OHM	SLGF_100_1_1000HM	SLGF_100_1_10HM
Actual	SLGF_100_1_1000OHM	100.0 %	0.0 %	0.0 %
	SLGF_100_1_1000HM	0.0 %	100.0 %	0.0 %
	SLGF_100_1_10HM	0.0 %	0.0 %	100.0 %

Fig.8 Confusion Matrix for CNN of Test 2

In Fig. 8 explained in Confusion matrix for CNN that the single line to ground fault at 100% Petersen coil compensated at fault resistance 1, 100, 1000 Ohm for each feeder-detected accuracy 100% for Test 2.

Confusion matrix for SVM (showing proportion of predicted)				
		Predicted		
		SLGF_100_1_1000OHM	SLGF_100_1_1000HM	SLGF_100_1_10HM
Actual	SLGF_100_1_1000OHM	100.0 %	0.0 %	0.0 %
	SLGF_100_1_1000HM	0.0 %	100.0 %	0.0 %
	SLGF_100_1_10HM	0.0 %	0.0 %	100.0 %

Fig.9 Confusion Matrix for SVM of Test 2

In Fig. 9 explained in Confusion matrix for SVM that the single line to ground fault at 100% Petersen coil compensated at fault resistance 1, 100, 1000 Ohm for each feeder-detected accuracy 100% for Test2.

Confusion matrix for AdaBoost (showing proportion of predicted)				
		Predicted		
		SLGF_100_1_1000OHM	SLGF_100_1_1000HM	SLGF_100_1_10HM
Actual	SLGF_100_1_1000OHM	100.0 %	0.0 %	0.0 %
	SLGF_100_1_1000HM	0.0 %	100.0 %	0.0 %
	SLGF_100_1_10HM	0.0 %	0.0 %	100.0 %

Fig.10 Confusion Matrix for Adaboost of Test 2

In Fig.10 explained in Confusion matrix for Adaboost that SLGF fault at 100% Petersen coil compensated at fault resistance 1, 100, 1000 Ohm for each feeder-detected accuracy 100% for Test2.



Table 6: Scores of Test 3

Scores					
Model	AUC	CA	F1	Precision	Recall
SVM	0.9999319727891156	0.9904761904761905	0.9905090012497044	0.9907407407407407	0.9904761904761905
CNN		1.0	0.9952380952380953	0.9952378522713743	0.9953051643192488
AdaBoost	0.9642857142857143	0.9523809523809523	0.9522370940619564	0.9523498288204171	0.9523809523809523

The Table 6 explained CA for CNN is 0.995, SVM is 0.995 and Adaboost is 0.952, therefore CNN is best to detected fault for Test3.

Confusion matrix for CNN (showing proportion of predicted)

		Predicted		
		SLGF_100%_F1_1OHM	SLGF_110%_F1_1OHM	SLGF_90%_F1_1OHM
Actual	SLGF_100%_F1_1OHM	100.0 %	0.0 %	0.0 %
	SLGF_110%_F1_1OHM	0.0 %	98.6 %	0.0 %
	SLGF_90%_F1_1OHM	0.0 %	1.4 %	100.0 %

Fig.11 Confusion Matrix for CNN of Test 3

In Fig.11 explained Confusion Matrix for CNN with SLGF at 90%, 100%, and 110% of Petersen Coil Compensated at Resistance fault 1 Ohm. In 110% explained is 98.6% for Test3.

Confusion matrix for SVM (showing proportion of predicted)

		Predicted		
		SLGF_100%_F1_1OHM	SLGF_110%_F1_1OHM	SLGF_90%_F1_1OHM
Actual	SLGF_100%_F1_1OHM	100.0 %	0.0 %	1.4 %
	SLGF_110%_F1_1OHM	0.0 %	100.0 %	1.4 %
	SLGF_90%_F1_1OHM	0.0 %	0.0 %	97.2 %

Fig.12 Confusion Matrix for SVM of Test 3

In Fig.12 explained Confusion Matrix for SVM with SLGF at 90%, 100%, and 110% of Petersen Coil Compensated at Resistance fault 1 Ohm. In 90% explained 97.6% for Test 3.

Confusion matrix for AdaBoost (showing proportion of predicted)

		Predicted		
		SLGF_100%_F1_1OHM	SLGF_110%_F1_1OHM	SLGF_90%_F1_1OHM
Actual	SLGF_100%_F1_1OHM	97.1 %	0.0 %	2.9 %
	SLGF_110%_F1_1OHM	0.0 %	94.4 %	2.9 %
	SLGF_90%_F1_1OHM	2.9 %	5.6 %	94.1 %

Fig.13 Confusion Matrix for Adaboost of Test 4

In Fig.13 explained Confusion Matrix for Adaboost with SLGF at 90%, 100%, and 110% of Petersen Coil Compensated at Resistance fault 1 Ohm. In 110% is 94.4%, and in 90% is 94.4% for Test 3.

Table 7: Scores of Test 4

Scores					
Model	AUC	CA	F1	Precision	Recall
SVM	0.8725850340136053	0.6095238095238096	0.6066337719298245	0.607793664143538	0.6095238095238096
CNN	0.8448978591836735	0.7095238095238096	0.7091528309919115	0.7097435897435898	0.7095238095238096
AdaBoost	0.7035714285714285	0.6047619047619047	0.6059409783090155	0.60906838122028	0.6047619047619047

The Table 7 explained CA for CNN is 0.709, SVM is 0.609 and Adaboost is 0.604, therefore CNN is best to detected fault for Test 4.

Confusion matrix for CNN (showing proportion of predicted)

		Predicted		
		SLGF_100%_F1_1OHM_FAULTFEEDER	SLGF_100%_F2_1OHM_SOUNDFEEDER	SLGF_100%_F3_1OHM_SOUNDFEEDER
Actual	SLGF_100%_F1_1OHM_FAULTFEEDER	100.0 %	0.0 %	0.0 %
	SLGF_100%_F2_1OHM_SOUNDFEEDER	0.0 %	56.9 %	44.0 %
	SLGF_100%_F3_1OHM_SOUNDFEEDER	0.0 %	43.1 %	56.0 %

Fig.14 Confusion Matrix for CNN of Test 4

In Fig.14 explained Confusion Matrix for CNN with SLGF at 100% of Petersen Coil Compensated at Resistance fault 1 Ohm. The Faulty feeder is 100%, but 56.9% for healthy feeder 2, and 56% for healthy feeder 3 for Test 4.

Confusion matrix for SVM (showing proportion of predicted)

		Predicted		
		SLGF_100%_F1_1OHM_FAULTFEEDER	SLGF_100%_F2_1OHM_SOUNDFEEDER	SLGF_100%_F3_1OHM_SOUNDFEEDER
Actual	SLGF_100%_F1_1OHM_FAULTFEEDER	100.0 %	0.0 %	0.0 %
	SLGF_100%_F2_1OHM_SOUNDFEEDER	0.0 %	39.7 %	57.3 %
	SLGF_100%_F3_1OHM_SOUNDFEEDER	0.0 %	60.3 %	42.7 %

Fig.15 Confusion Matrix for SVM of Test 4

In Fig.15 explained Confusion Matrix for SVM with SLGF at 100% of Petersen Coil Compensated at Resistance fault 1 Ohm. The Faulty feeder is 100%, but 39.7 % for healthy feeder 2, and 42.7% for healthy feeder 3 for Test 4.

Confusion matrix for Adaboost (showing proportion of predicted)

		Predicted		
		SLGF_100%_F1_1OHM_FAULTFEEDER	SLGF_100%_F2_1OHM_SOUNDFEEDER	SLGF_100%_F3_1OHM_SOUNDFEEDER
Actual	SLGF_100%_F1_1OHM_FAULTFEEDER	100.0 %	3.2 %	0.0 %
	SLGF_100%_F2_1OHM_SOUNDFEEDER	0.0 %	39.7 %	57.0 %
	SLGF_100%_F3_1OHM_SOUNDFEEDER	0.0 %	57.1 %	43.0 %

Fig.16 Confusion Matrix for Adaboost of Test 4

In Fig.16 explained Confusion Matrix for SVM with SLGF at 100% of Petersen Coil Compensated at Resistance fault 1 Ohm. The Faulty feeder is 100%, but 39.7 % for healthy feeder 2, and 43% for healthy feeder 3 for Test 4.

In Fig.17 showed the three-phase voltage and current at bus connected with secondary side of distribution transformer.

In Fig.18 showed the three-phase voltage and current at bus connected with secondary side of distribution transformer. When happened fault at 0.02 second.

In Fig.19, fig.20 and fig.21 showed zero sequence current for faulty feeder 1 at resistance fault 1,100 and 1000 Ohm, respectively.

In Fig.22 and Fig.23 showed Zero sequence current for healthy feeder when fault happened in feeder 1.

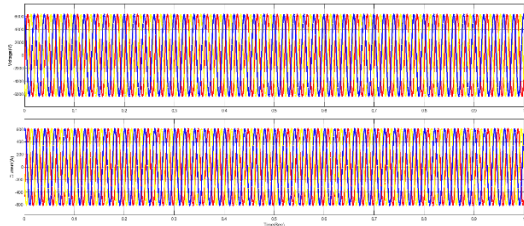

Fig.17 Three-phase voltage and current in Bus at No fault

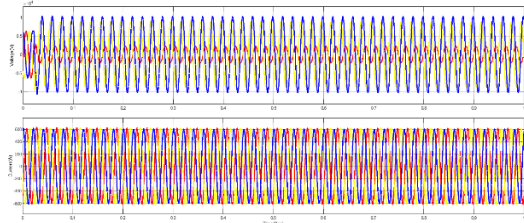

Fig.18 Three-phase voltage and currents in Bus at Fault in Feeder1

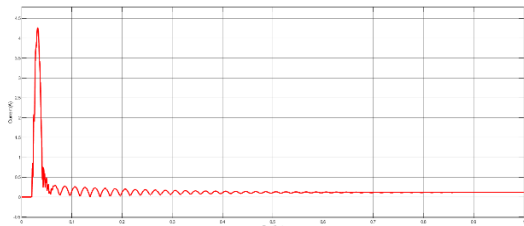

Fig.19 ZSC of Faulty Feeder 1 at  $R_f$  1 Ohm

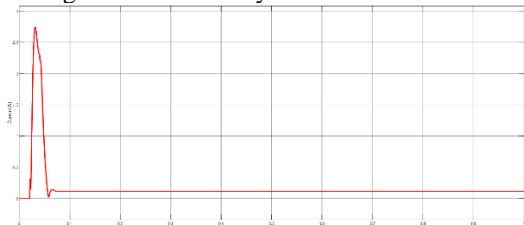

Fig.20 ZSC of Faulty Feeder 1 at  $R_f$  100 Ohm

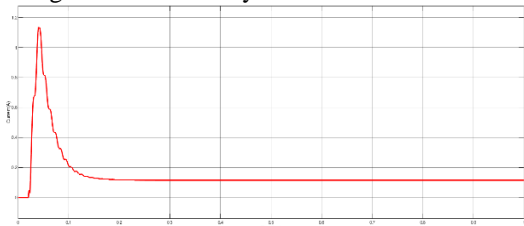

Fig.21 ZSC of Faulty Feeder 1 at  $R_f$  1000 Ohm

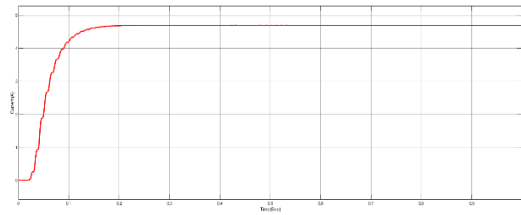

Fig.22 Healthy Feeder 2 at Faulty Feeder 1 at  $R_f$  1000 Ohm

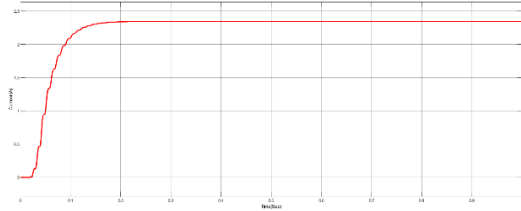

Fig.23 Healthy Feeder 3 at Faulty Feeder 1 at  $R_f$  1000 Ohm

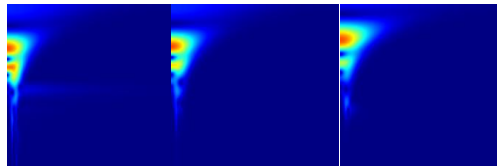

Fig.24 RGB Scale images of Faulty Feeder1 of ZSC signals at 1,100 and 1000 $\Omega$

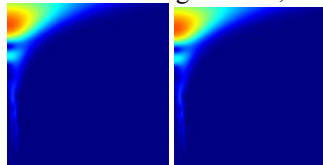

Fig.25 RGB Scale images of Healthy Feeders at fault in Feeder1 at fault resistance 1 $\Omega$

### 5. CONCLUSION

The time-frequency RGB scale images of SLGF signals in a distribution system protected by Petersen coil are created in this study using CWT. The CNN input is regarded as the RGB scale image. Choosing the features and classifier is resolved using a CNN-based fault detection method. The benefit of using a trained CNN is that it can reliably identify the faulty feeder.

The Tests results showed that the suggested fault detection system is reliable and robust despite a wide range of fault situations and interfering factors. The suggested method outperforms methods based on traditional machine learning algorithms, like the Adaboost or SVM, in terms of fault detection.

## REFERENCES

- [1] H. Chen, P. D. S. Assala, Y. Cai, and P. Yang, "Intelligent transient overvoltages location in distribution systems using wavelet packet decomposition and general regression neural networks," *IEEE Trans. Industr. Inform.*, vol. 12, no. 5, pp. 1726–1735, 2016.
- [2] Y. Wang, J. Zhou, Z. Li, Z. Dong, and Y. Xu, "Discriminant-analysis-based single-phase earth fault protection using improved PCA in distribution systems," *IEEE Trans. Power Deliv.*, vol. 30, no. 4, pp. 1974–1982, 2015.
- [3] T. Ji, Q. Pang, and X. Liu, "Study on fault line detection based on genetic artificial neural network in compensated distribution system," in *2006 IEEE International Conference on Information Acquisition*, 2006.
- [4] X. Zeng *et al.*, "A novel single phase grounding fault protection scheme without threshold setting for neutral ineffectively earthed power systems," *CSEE J. Power Energy Syst.*, vol. 2, no. 3, pp. 73–81, 2016.
- [5] N. I. Elkalashy, A. M. Elhaffar, T. A. Kawady, N. G. Tarhuni, and M. Lehtonen, "Bayesian selectivity technique for earth fault protection in medium-voltage networks," *IEEE Trans. Power Deliv.*, vol. 25, no. 4, pp. 2234–2245, 2010.
- [6] Z. Shao, L. Wang, and H. Zhang, "A fault line selection method for small current grounding system based on big data," in *2016 IEEE PES Asia-Pacific Power and Energy Engineering Conference (APPEEC)*, 2016.
- [7] Y. Wang *et al.*, "Faulty feeder detection of single phase-earth fault using grey relation degree in resonant grounding system," *IEEE Trans. Power Deliv.*, vol. 32, no. 1, pp. 55–61, 2017.
- [8] T. M. Lai, L. A. Snider, E. Lo, and D. Sutanto, "High-impedance fault detection using discrete wavelet transform and frequency range and RMS conversion," *IEEE Trans. Power Deliv.*, vol. 20, no. 1, pp. 397–407, 2005.
- [9] P. Malla, W. Coburn, K. Keegan, and X.-H. Yu, "Power system fault detection and classification using wavelet transform and artificial neural networks," in *Advances in Neural Networks – ISNN 2019*, Cham: Springer International Publishing, 2019, pp. 266–272.
- [10] *The illustrated wavelet transform handbook: Introductory theory and applications in science, engineering, medicine and finance.* .
- [11] J. Gu *et al.*, "Recent advances in convolutional neural networks," *arXiv [cs.CV]*, 2015.
- [12] L. Chen, S. Li, Q. Bai, J. Yang, S. Jiang, and Y. Miao, "Review of image classification algorithms based on convolutional neural networks," *Remote Sens. (Basel)*, vol. 13, no. 22, p. 4712, 2021.
- [13] D. A. Mahmood and H. Mahmood, "Automatic triple-A segmentation of skin cancer images based on histogram classification," *AL-Rafidain Engineering Journal (AREJ)*, vol. 23, no. 5, pp. 31–42, 2015.
- [14] L. Sufer Ali and H. Mohammed Hussein, "An efficient algorithm for eye detection in faces images," *AL-Rafidain Engineering Journal (AREJ)*, vol. 23, no. 1, pp. 23–29, 2015.
- [15] Z. Al-Mokhtar, F. Ibraheem, and H. Al-Layla, "A review of digital image fusion and its application," *Al-Rafidain Engineering Journal (AREJ)*, vol. 26, no. 2, pp. 309–322, 2021.
- [16] K. Kavitha, B. Sandhya, and B. Thirumala, "Evaluation of Distance Measures for Feature based Image Registration using AlexNet," *Int. J. Adv. Comput. Sci. Appl.*, vol. 9, no. 10, 2018.
- [17] M.-F. Guo, X.-D. Zeng, D.-Y. Chen, and N.-C. Yang, "Deep-learning-based earth fault detection using continuous wavelet transform and convolutional neural network in resonant grounding distribution systems," *IEEE Sens. J.*, vol. 18, no. 3, pp. 1291–1300, 2018.
- [18] R. Wang, "AdaBoost for feature selection, classification and its relation with SVM, A review," *Phys. Procedia*, vol. 25, pp. 800–807, 2012.
- [19] L. Tiantian and Z. Hongwei, "Large scale classification with local diversity AdaBoost SVM algorithm," *Journal of Systems Engineering and Electronics*, vol. 20, pp. 1344–1350, 2009.
- [20] J. Wang, X. Xiong, N. Zhou, Z. Li, and W. Wang, "Early warning method for transmission line galloping based on SVM and AdaBoost bi-level classifiers," *IET Gener. Transm. Distrib.*, vol. 10, no. 14, pp. 3499–3507, 2016.
- [21] B. Qiang *et al.*, "SqueezeNet and fusion network-based accurate fast fully convolutional network for hand detection and gesture recognition," *IEEE Access*, vol. 9, pp. 77661–77674, 2021.
- [22] E. Bisong and E. Bisong, "Training a Neural Network," in *Building Machine Learning and Deep Learning Models on Google Cloud Platform: A Comprehensive Guide for Beginners*, 2019, pp. 333–343.



## منظومة توزيع القدرة المحمية بملف بيترسون: اكتشاف العطل الأرضي المفرد باستعمال خوارزميات التعلم العميق

عبدالغني عبدالرزاق الطائي  
Drabdulghani18@uomosul.edu.iq

قصي مؤيد محمد  
Qusay.20enp63@student.uomosul.edu.iq

قسم الهندسة الكهربائية، كلية الهندسة، جامعة الموصل، الموصل، العراق

تاريخ القبول: 2 مارس 2023

استلم بصيغته المنقحة: 24 فبراير 2023

تاريخ الاستلام: 30 ديسمبر 2022

### الملخص

في جميع تقنيات كشف الاعطال، يعد استخراج الميزات لإشارات الأعطال أمراً بالغ الأهمية وصعباً. إذ تم اقتراح تقنية تحويل الموجية المستمرة (CWT) والشبكة العصبية الالتفافية (CNN) للكشف عن المغذي العاطل في نظام توزيع القدرة المحمي بواسطة ملف بيترسون في هذا البحث. باستخدام CWT على إشارات التيار ذات التعاقب الصفري للمغذي العاطل والمغذيات السليمة، إذ تم الحصول على صور المقياس الملون RGB للتردد-الزمن. حيث ان CNN تم تدريبها بواسطة عدد قليل من الصور ذات المقياس RGB وفي ظل أنواع مختلفة من ظروف وعوامل العطل، وباستخراج سمات صور المقياس RGB بشكل تكيفي. إذ تمكنت CNN المدربة باستخراج الميزات والكشف عن المغذي العاطل في نفس الوقت. وتم عرض تقنيتين للكشف عن المغذي العاطل على أساس استخراج الميزات الاصطناعية والتعلم الآلي التقليدي من أجل المقارنة. وتمت محاكاة نظام توزيع القدرة المحمي بواسطة ملف بيترسون ببرنامج ماتلاب للمحاكاة وتسجيل تيارات التعاقب الصفري ثم تحليلها بواسطة اداة Orange Big Mining. وتمت مقارنة كفاءة وأداء الطريقة المقترحة للكشف عن المغذي العاطل وتأكيدها في ظل سيناريوهات مختلفة للأعطال. وتم استنتاج ان CNN أفضل في اكتشاف العطل الأرضي المفرد في ظروف مختلفة، في الاختبار 1 و2 كانت دقة التصنيف 100%، والاختبار 3 كانت 99.5%، والاختبار 4 كانت 70.9%.

### الكلمات الدالة:

العطل الأرضي المنفرد، ملف بيترسون، اكتشاف المغذي العاطل، الشبكة العصبية الالتفافية (CNN)، تحويل الموجية.