

Suhad H. JasimDepartment of Electrical
Engineering, University of
Technology, Baghdad, Iraq.
30150@uotechnology.edu.iqReceived on: 07/06/2017
Accepted on: 12/10/2017

Analytical Comparison on Inductive Wireless Power Transfer System for Biomedical Devices

Abstract- This paper presents a comparative analysis for the four basic topologies of inductive link wireless power transmission, thereby allowing designers to select the most appropriate topology according to the requirements of the application. Wireless energy transfer systems applied for diagnostic or monitoring signals in biomedical devices to eliminate the needs for tethering wires or implantable batteries. Inductive link studied as main technique in wireless power transmission for biomedical devices. In various applications, the maximum delivered power and maximum efficiency of an inductive link system are two important factors to be considered. The efficiency expression for power transfer of the four topologies (series – series, parallel – series, parallel – parallel, series-parallel) has been derived. For biomedical devices, theoretically the series – series topology has been identified as the most suited due to its independency on the coupling coefficient however, series-parallel topology is widely used in practice. The circuits have been simulated using ADS simulator of keysight technology at a resonant frequency of 13.56MHz.

Keywords- : Inductive Link, Wireless Transmission, inductive coupling, implanted devices maximum power transfer efficiency, boundary frequency.

How to cite this article: S.H. Jassim, "Analytical Comparison on Inductive Wireless Power Transfer System for Biomedical Devices," *Engineering and Technology Journal*, Vol. 36, Part A, No. 6, pp. 612-619, 2018.

1. Introduction

The transfer of power or electric energy from a power source to the load without using any physical connection between them can be defined as Wireless Power Transfer (Witricity). Depends on the required amount of the transmitted power, the distance between the transmitter, the receiver coils, and the operating frequency, alternative techniques used in wireless power transmission. The three main techniques are the inductive coupling between two separated coils (transmitter and receiver), the microwave power transmission and the third type based on the use of laser technology. Wireless powering for a distance of a few centimeters utilizes reactive coupling such as capacitive and inductive techniques at an operating frequency of several megahertz. As the names refer, inductive coupling is due to a magnetic coupling whereas capacitive coupling is due to electrical coupling. Capacitive coupling is more sensitive to distance variation and requires a dielectric medium while inductive coupling depends on the mutual inductance between two coupled coils, so it is more preferred for the powering of the biomedical devices. In inductive coupling, the power is transformed from DC to AC and a magnetic field is created around the transmitter coil. In practice, the number of the coil turns can be changed depending on coils

shape and the properties of the wire. A more practical approach involves measuring the inductance during construction and odd turns until the specified inductance is reached [1]. A part of the alternating magnetic field generated by the transmitter will be cut by the receiver coil, where an AC current is induced. The received AC power is rectified to produce the required output DC power. Systems based on inductive coupling have low power transfer efficiency when the distance between the transmitter and the receiver coils is increased. As the distance increases, the receiver coil loses more lines of the magnetic field of the transmitter, which causes most of the transmitted power to be wasted. The main structure of wireless power transfer system is shown in Figure 1, it consists of a high speed switching power source, primary impedance compensating network, two magnetically coupled coils, a secondary impedance compensating network, AC- DC rectifier, a voltage regulator and a load.

The biomedical devices have created two main difficulties in the design of power and data transfer capability. Transferring power and data into the patient's body is possible by using wires even though it reduces the quality for long-term monitoring applications.

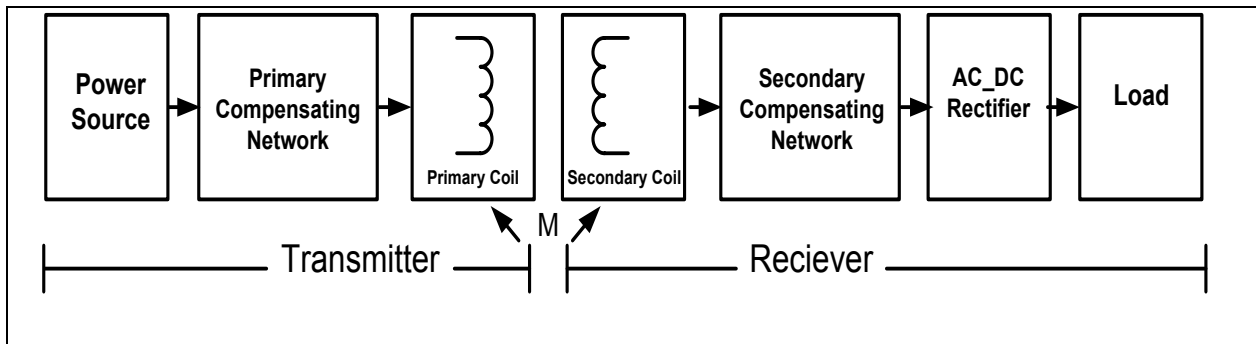

Figure 1: Block Diagram of Inductive Link Wireless Power Transfer System.

Wireless power coupling technique introduces a flexible solution to avoid surgical operations to replace old batteries. These implanted biomedical devices applied for medical applications are imperative but when they malfunction, it cannot be repaired because they are difficult to access.

2. Applications of Wireless Power Transfer System

Recently, wireless power transmission based on inductive link has a wide range of applications. Wireless charging devices for laptops and Mobile phones increases the mobility of these devices and avert the wiring hazards. Electric toothbrush is a preferable application for induction coils to recharge the brush while water makes charging using electric plug unsafe. Due to the existence of skin, air and tissue between the transmitter and the receiver coils, efficiency of inductive power transmission will be limited for biomedical devices in medical application such as Cochlear Implant, Pacemaker, Intraocular, and Bladder Implant.

3. Advantages and Limitations of Wireless Power Transfer

The power can be transferred in any direction by using a magnetic field, which is not harmful to users. Transferring the power wirelessly will avoid the wiring hazard, saving the wiring cost; eliminating mechanical connectors will prevent corrosion, sparking and increase the mobility of the devices. In addition, wireless power transmission enhances the research of biomedical devices in medical applications. On the other hand, power transfer becomes inefficient when the distance between the transmitter and receiver coils increases because the magnetic coupling will be reduced. When a ferromagnetic substance presented between the transmitter and receiver coil some of the transmitted power will be lost. There is need for standardization and adaptation to avoid overheating that occurs because of

different voltages, it requires completely new hardware, which could become very expensive, less efficiency compared to traditional charging.

4. Health risks of Implantable Medical Devices

Despite significant research effort, microorganism contamination has always been a problem in implantable medical devices. Bacteria have the ability to colonize synthetic materials like synthetic fibers used in fabrications of catheters, hips and knee implants and many other devices. Biomedical implantation must meet several requirements. First of all and most important requirement is that it must be accepted by the human body. In other words, it shouldn't cause any allergy, inflammation or toxicity either immediately or after surgery or post-operative. It should possess mechanical strength to endure the forces it's subjected to, so they should have high resistance to breakage or corrosion in different body environments and withstand the different pressure conditions in the human body, apart from fatigue strength and fracture toughness. Above all that, biomaterial should remain intact for a long period of time, which is until the patient's death which means a minimum service period of from 15 to 20 years in older patients and more than 20 years for younger patients. The success of biomedical implant depends on several factors. Firstly the chemical and mechanical properties of the biomaterial. Secondly biocompatibility of the implant. Lastly the recipient's health condition and the surgeon's competency. The currently used materials are selected based on the criteria above. Even though they fail to continue to function in the human body after 12-15 years, which leads to another surgery to regain the functionality of the system [2].

5. Compensation Networks

In order to maximize the transferred power and reduce losses due to poor coupling between the transmitter and receiver coils in the system, the inductance of the coils should be compensated by adding series or parallel capacitances that resonate with the coil inductance. Fundamentally, by adding a series capacitor the real part of the impedance will not be changed and introduces only a negative reactance. On the other hand, adding a parallel capacitor changes both the real and imaginary parts of the impedance. Configuration of the compensating network could be selected depending on the limitations on load, source impedances and the characteristics of the application requirements for the wireless powering devices. In Figure 2, the four typical compensation networks are shown. Primary and secondary capacitors (C_1, C_2) are added either in series or in parallel to resonate with corresponding inductors (L_1, L_2). Addition of these capacitors will improve the efficiency for longer distances compared with non-resonant inductive coupling power transfer. The typical four topologies of the inductive power transfer are series – series (SS), parallel – series (PS), parallel –parallel (PP), and series-parallel (SP). Many precepts can be provided for choosing the best compensating topology, according to the requirements and limitations of the application. In design methodology, the following rules should be taken in attention.

- For variable load, the system desires adding a series primary capacitance, since C_1 in SS or SP topologies independent on the load [3].
- For variable magnetic coupling, the system desires adding series secondary compensation

capacitance, since C_1 and C_2 in SS are independent on mutual inductance [4].

- For fixed coupling and load, the more suitable secondary compensated topology would be chosen in consonance with the load and secondary inductance values [5, 6].

- For the system with non-negligible parasitic parallel capacitance of the inductance, adding parallel compensated capacitance is the most suited topology, that is, the parallel capacitance that resonate with coil can be accounted with the parasitic capacitance of the coil [7].

- The system will require adding a parallel compensation, when the real part of the input impedance is dominated by coil resistance, because adding a parallel capacitance affects the real part of the equivalent impedance [8].

Inductive links with a series resonant secondary have a current output, they only match to small a.c. load resistors while inductive links with a parallel- resonant secondary have a voltage output, they only suitable for large a.c. load resistors [9].

The series-series topology is adopted widely because of its simplicity in design and its independency on the variation of many parameters such as mutual inductance and the load. More complicated topologies have been studied, such as adaptive matching [10, 11], and additional self-resonant coils [12, 13].

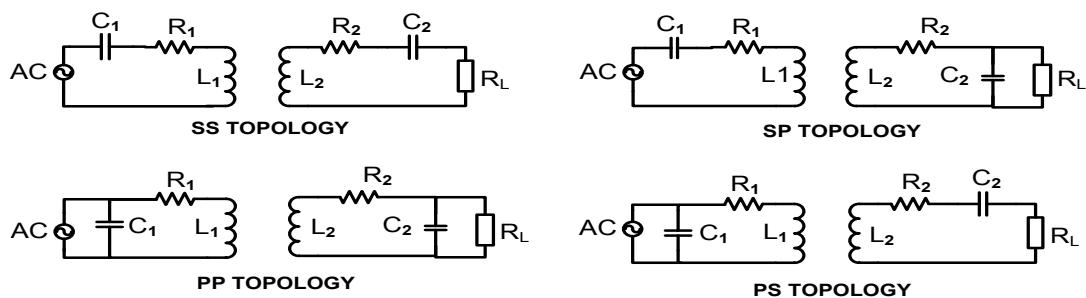

Figure 2: The Four Different Topologies for Inductive Power Transfer.

6. Power Transfer Capability of Wireless Power Transmission

The power transfer capability of inductive wireless power transfer system can be derived by using the same procedure provided in [14]. The secondary load impedance (Z_s) can be calculated

as lumped impedance whose value depends on the secondary compensation as given by:

$$Z_s^{SS/PS} = j\omega L_2 + \frac{1}{j\omega C_2} + R_2 + R_L \quad (1)$$

$$Z_s^{SP/PP} = j\omega L_2 + \frac{1}{j\omega C_2 + \frac{1}{R_L}} + R_2 \quad (2)$$

The reflected impedance of the secondary load impedance (Z_r) is dependent on the coupling

factor (K) between the primary and the secondary coils and the operating frequency as given by:

$$Z_r = \frac{\omega^2 M^2}{Z_s} \quad (3)$$

Where (M) is the mutual inductance ($M = K\sqrt{L_1 L_2}$). Substituting equations (1) and (2) into (3) the reflected resistance (ReZ_r) and reactance (ImZ_r) at resonance frequency can be derived as:

$$ReZ_r^{SS/PS} = \frac{\omega^4 C_2^2 M^2 (R_L + R_2)}{(\omega^2 C_2 L_2 - 1)^2 + \omega^2 C_2^2 (R_L + R_2)^2} \quad (4)$$

$$ReZ_r^{PP/SP} = \frac{\omega^2 M^2 (R_L + R_2 + \omega^2 R_L^2 R_2 C_2^2)}{[R_2 + R_L(\omega^2 C_2 L_2 - 1)]^2 + \omega^2 (L_2 + C_2 R_2 R_L)^2} \quad (5)$$

$$ImZ_r^{SP/PP} = \frac{-\omega C_2 R_L^2 (\omega^2 C_2 L_2 - 1) - \omega L_2}{[R_2 + R_L(\omega^2 C_2 L_2 - 1)]^2 + \omega^2 (L_2 + C_2 R_2 R_L)^2} \quad (6)$$

$$ImZ_r^{SS/PS} = \frac{-\omega^3 M^2 C_2 (\omega^2 C_2 L_2 - 1)}{(\omega^2 C_2 L_2 - 1)^2 + \omega^2 C_2^2 (R_L + R_2)^2} \quad (7)$$

If the system is operating at the resonance frequency given by:

$$\omega_o = \frac{1}{\sqrt{L_1 C_1}} = \frac{1}{\sqrt{L_2 C_2}} \quad (8)$$

To make the two coils resonant some conditions must be satisfied:

$$J\omega L_1 + \frac{1}{J\omega C_1} = 0 \quad (9)$$

$$J\omega L_2 + \frac{1}{J\omega C_2} = 0 \quad (10)$$

Then the reflected resistance and reactance become the following simple equations:

$$ReZ_r^{SS/PS} = \frac{\omega^2 M^2}{R_2 + R_L} \quad (11)$$

$$ReZ_r^{PP/SP} = \frac{M^2 \omega^2 (R_2 + R_L + \omega^2 C_2^2 R_2 R_L^2)}{R_2^2 + \omega^2 (L_2 + C_2 R_L R_2)^2} \quad (12)$$

$$ImZ_r^{SS/PS} = 0 \quad (13)$$

$$ImZ_r^{PP/SP} = \frac{-\omega^3 M^2 L_2}{R_2^2 + \omega^2 (L_2 + C_2 R_L R_2)^2} \quad (14)$$

It can be indicated from above equations that, the main difference between series and parallel secondary capacitance that in series capacitance the reflected reactance is zero, whereas in the parallel capacitance reflects a capacitive load.

7. Primary capacitance

The input impedance (Z_{in}) seen by the source for the series and parallel primary compensated topologies are given as:

$$Z_{in}^{SS/SP} = Z_r + J\omega L_1 + R_1 + \frac{1}{J\omega C_1} \quad (15)$$

$$Z_{in}^{PP/PS} = (Z_r + R_1 + J\omega L_1) // \left(\frac{1}{J\omega C_1}\right) \quad (16)$$

$$Z_{in}^{SS} = \frac{\omega^2 M^2}{R_2 + R_L} + J\omega L_1 + R_1 + \frac{1}{J\omega C_1} \quad (17)$$

$$Z_{in}^{SP} = \frac{M^2 \omega^2 (R_2 + R_L + \omega^2 C_2^2 R_2 R_L^2) - J\omega^3 M^2 L_2}{R_2^2 + \omega^2 (L_2 + C_2 R_L R_2)^2} + J\omega L_1 + R_1 + \frac{1}{J\omega C_1} \quad (18)$$

$$Z_{in}^{PS} = \left(\frac{\omega^2 M^2}{R_2 + R_L} + R_1 + J\omega L_1\right) // \left(\frac{1}{J\omega C_1}\right) \quad (19)$$

$$Z_{in}^{PP} = \left(\frac{M^2 \omega^2 (R_2 + R_L + \omega^2 C_2^2 R_2 R_L^2) - J\omega^3 M^2 L_2}{R_2^2 + \omega^2 (L_2 + C_2 R_L R_2)^2} + R_1 + J\omega L_1\right) // \left(\frac{1}{J\omega C_1}\right) \quad (20)$$

The primary capacitance is selected to resonate with both the primary inductance and the reactance of the reflected impedance to ensure zero phase load operating point for the sources. This is done by applying the following condition:

$$Im(Z_{in}) = 0 \quad (21)$$

The primary capacitance for the four topologies is given as:

$$C_1^{SS} = \frac{1}{\omega^2 L_1} \quad (22)$$

$$C_1^{PS} = \frac{L_1}{\left(R_1 + \frac{\omega^2 M^2}{R_L + R_2}\right)^2 + \omega^2 L_1^2} \quad (23)$$

$$C_1^{SP} = \frac{1}{\omega^2 \left[L_1 - \frac{\omega^2 M^2 L_2}{R_2^2 + \omega^2 (L_2 + C_2 R_2 R_L)^2}\right]} \quad (24)$$

$$C_1^{PP} = \frac{L_1 - \frac{\omega^2 M^2 L_2}{R_2^2 + \omega^2 (L_2 + C_2 R_2 R_L)^2}}{\left[R_1 + \frac{\omega^2 M^2 (R_2 + R_L + \omega^2 C_2^2 R_2 R_L^2)}{R_2^2 + \omega^2 (L_2 + C_2 R_2 R_L)^2}\right]^2 + \omega^2 \left[L_1 - \frac{\omega^2 M^2 L_2}{R_2^2 + \omega^2 (L_2 + C_2 R_2 R_L)^2}\right]^2} \quad (25)$$

For series primary compensated network, the capacitance is independent on the load while in parallel primary compensated network the capacitance depends on the load value therefore it should be designed with respect the required output power because any variation in the load will affect the value of the capacitance.

8. Power Transfer Capability

The input power (P_{in}) drawn from the source is simply the square of the primary current (I_p) multiplied by the sum of the reflected and primary resistances can be given by:

$$P_{in} = (ReZ_r + R_1) I_p^2 \quad (26)$$

Where the primary current as a function of the supply voltage (V) can be given as:

$$I_P = \frac{V}{R_1 + ReZr} \quad (27)$$

The power delivered to the load is the square of the secondary current (I_S) multiplied by the load resistance and can be given as:

$$P_L = I_S^2 R_L \quad (28)$$

Expressions of the output power for the four topologies have been deduced at resonance frequency:

$$P_L^{SS} = \frac{V^2 M^2 \omega^2 R_L}{[R_1(R_2 + R_L) + M^2 \omega^2]^2} \quad (29)$$

$$P_L^{PS} = \frac{V^2 M^2 \omega^2 R_L}{[R_1(R_2 + R_L + M^2 \omega^2)]^2 + \omega^2 L_1^2 (R_2 + R_L)^2} \quad (30)$$

$$P_L^{PP} = \frac{V^2 M^2 \omega^2 R_L (1 + \omega^2 C_2^2 R_L^2) [R_2^2 + \omega^2 (L_2 + R_2 R_L C_2)^2]^2}{(R_1 A B + B^2 M^2 \omega^2 - \omega^2 L_1 L_2 A)^2 + (A B \omega L_1 + A \omega L_2 R_1 + M^2 \omega^3 L_2)^2} \quad (31)$$

$$P_L^{SP} = \frac{V^2 M^2 \omega^2 R_L A^2 (1 + \omega^2 C_2^2 R_L^2)}{(R_1 A + M^2 \omega^2 B)^2 (B^2 + \omega^2 L_2^2)} \quad (32)$$

$$A = R_2^2 + \omega^2 (L_2 + R_2 R_L C_2)^2 \quad (33)$$

$$B = R_2 + R_L + \omega^2 C_2^2 R_L^2 R_2 \quad (34)$$

From above equations, for a constant primary current, the power at the load will vary with respect to the mutual inductance, resonant frequency, load value and the internal resistance of the secondary inductance. Since the internal resistance of the coil can't be changed once the coil is fabricated, the load power will vary directly with respect to the mutual inductance.

9. Efficiency of Wireless Power Transfer

The efficiency can be defined as the ratio of total power delivered to the load divided by the total power that is drawn from the source in one complete cycle. Some of the transferred power is dissipated in the primary and secondary inductances and the rest of the power will deliver the load. It should be intimated that only the type of resonance in the secondary network affects the efficiency regardless of the type of the primary side. Therefore the efficiency of inductive power transfer system is given by:

$$\eta = \frac{P_L}{P_{in}} = \frac{I_S^2 R_L}{(ReZ_r + R_1) I_P^2} \quad (35)$$

$$\frac{I_S}{I_P} = \frac{\omega M}{R_2 + R_L} \quad (36)$$

Substituting the reflected resistance and equation (36) into (35), the power transfer efficiency of the four topologies can be given as:

$$\eta_{SS/PS} = \left\{ 1 + \frac{R_2}{R_L} + \frac{R_1}{K^2 L_1 L_2 R_L} \times \left\{ L_2 + \left[\frac{(R_L + R_2)^2}{L_2} - \frac{2}{C_2} \right] \frac{1}{\omega^2} + \left(\frac{1}{L_2 C_2^2} \right) \frac{1}{\omega^4} \right\} \right\}^{-1} \quad (37)$$

$$\eta_{PP/SP} = \left\{ 1 + \frac{R_2}{R_L} + \omega^2 R_L R_2 C_2^2 + \frac{R_1}{K^2 L_1 L_2 R_L} \left\{ \left[\frac{(1 - \omega^2 L_2 C_2) R_L + R_2}{\omega} \right]^2 + (L_2 + C_2 R_2 R_L)^2 \right\} \right\}^{-1} \quad (38)$$

It should be mentioned that the efficiency depends on the operating frequency and the physical parameters of the coils while the primary current and input voltage don't have any effect on it. In order to compute an expression for maximum efficiency at operating frequency, equations (37) and (38) derived with respect the secondary capacitance and equating it to zero. The value of C_2 is obtained as:

$$C_2^{SS/PS} = \frac{1}{\omega^2 L_2} \quad (39)$$

$$C_2^{PP/SP} = \frac{1}{\omega R_2 \left(\frac{K^2 \omega L_1 + \omega L_2 + R_2}{R_1} + \frac{R_2}{\omega L_2} \right)} \quad (40)$$

For the parallel compensated topology, the secondary capacitance that maximizes the efficiency depends on the coupling coefficient. This is not suitable for implanted biomedical devices since it suffers motion artifacts because of body movements and so the coupling between the primary and secondary coils will vary. Also the coupling coefficient varies from one patient to another. Hence it poses a challenge for the PP/SP topology to maintain the maximum efficiency and power transfer for variations in the coupling using the same hardware. Hence we can conclude that the SS topology is better than the SP topology for biomedical implants that suffer motion artifacts while in operation.

The maximum efficiency for the four topologies is determined by substituting (39) and (40) into (37) and (38) as given by:

$$\eta_{SS/PS}^{max} = \frac{1}{1 + \frac{R_2}{R_L} + \frac{R_1 (R_L + R_2)^2}{K^2 L_1 L_2 \omega^2 R_L}} \quad (41)$$

$$\eta_{SP/PP}^{max} = \left\{ 1 + \frac{R_2}{R_L} + \frac{R_1 R_2}{L_2^2 \omega^2} + \frac{R_1}{K^2 L_1 L_2 R_L} \times \left\{ \frac{R_2^2}{\omega^2} + \left[L_2 + \frac{R_2 R_L}{L_2 \omega^2} \right]^2 \right\} \right\}^{-1} \quad (42)$$

By comparing the maximum efficiency expression in equations (41) and (42) and by choosing the same value of primary and secondary inductances, the cross over frequency (f_c) at which the topologies with parallel and series secondary compensation have the same efficiency can be determined as given by:

$$f_c = \frac{R_L}{2\pi L_2} \left(\sqrt{1 - \frac{K^2 L_1 R_2}{L_2 R_1}} \right) \quad (43)$$

When the operating frequency is larger than the cross over frequency, the series compensated secondary topologies provide a higher efficiency compared with the parallel compensated secondary topology. It should be mentioned that the values of R_1 and R_2 are used in equation (43) are frequency dependent. However the ratio of R_2 to R_1 does not vary with respect to frequency and hence the ratio can be evaluated at any operating frequency and substituted in (43) to find the cross over frequency. Thus, we can deduce from equation (43) that series resonant topology is more suitable for smaller loads and higher operating frequency whereas parallel resonant topology is more suitable for larger loads and lower operating frequency. The operating frequency for implanted biomedical devices in medical applications is chosen based on health hazard and made to be compatible with RFID standards (13.56 MHz).

A theoretical Comparison for the four basic topologies with respect to the primary capacitance using the equations derived previously, the SS topology is the best topology to be chosen for biomedical devices since the primary capacitance is independent on both the load value and the coupling coefficient. The primary capacitance for the SP topology depends on the coupling coefficient, while for PS and PP topologies it is a function of both the load and the coupling coefficient. In medical applications, the coupling coefficient is different from a patient to another and due to the body movements, the magnetically coupling between the primary and secondary coils will vary. For these reasons, the PP/PS/SP topologies are not the preferred choice for biomedical devices but for many other applications. An inductively coupled wireless power transfer system designed for maximum efficiency. The secondary inductance assumed to be a squared spiral coil with a value of 9.5nH and an internal resistance of 5Ω, this value is chosen to be within a range of the spiral coil designed for biomedical devices in [15]. Then, the value of the secondary capacitance C_2 has been calculated by using equations (39) and (40). Different values for the primary inductance have been chosen (10uH and 100uH) to study and the variation of

the efficiency and power transfer with respect to the coupling coefficient. The AC voltage source has been set to 5V at an operating frequency 13.56MHz. The circuit has been simulated using ADS simulator from Keysight technologies. It can be mentioned from figures 3 and 4 that for SS topology, larger value of the primary inductance provides lower transferred power and higher efficiency. For a given coupling coefficient value, power at the load is dropped for larger values of L_1 because of the large mutual inductance which reduces the power drawn from the source. Therefore, the primary inductance should be selected to be small enough to deliver the required power to the load and large enough to get an accepted efficiency. After choosing the appropriate value of L_1 based on the required power and efficiency, C_1 is calculated using equations (22) and (25) to ensure zero-phase operating point for the source. Figure 5 describes the variation of efficiency with respect to frequency for different values of coupling coefficient for SS/PS topologies. The higher value of the coupling coefficient provides higher efficiency, as it can be observed from the equation (42). For PP/SP topologies, figures 6, 7 and 8 show the variation of the efficiency with respect to the frequency and coupling coefficient.

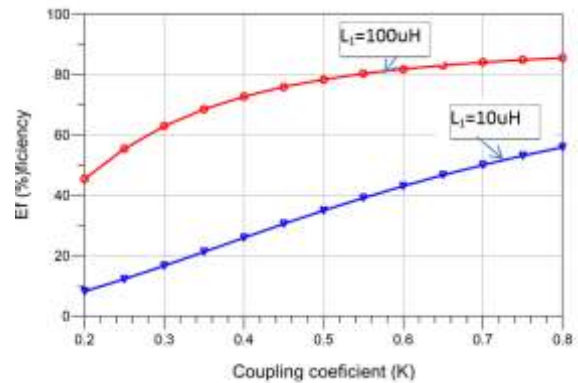

Figure 3: The Variation of Efficiency with Respect to Coupling Coefficient for SS/PS Topologies.

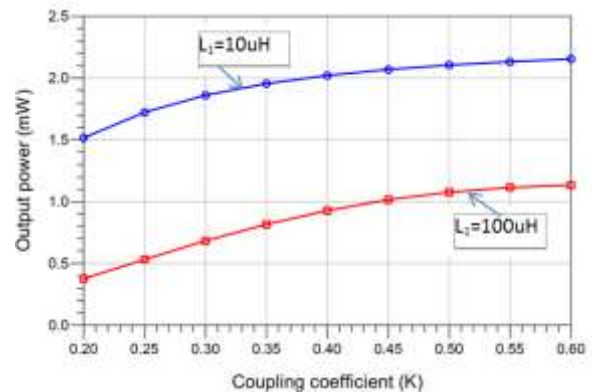

Figure 4: The Variation of the Power Delivered to the Load Verses Coupling Coefficient for SS Topology

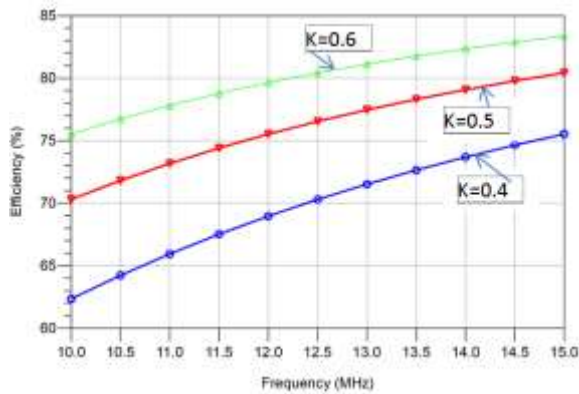

Figure 5: the Variation of Efficiency Verses Frequency for Different Values of Coupling Coefficient for SS/PS Topologies

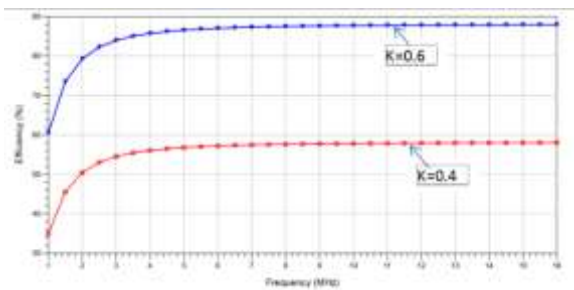

Figure 6: Efficiency Variation with respect to Frequency for Different Values of Coupling Coefficient for PP/SP Topologies

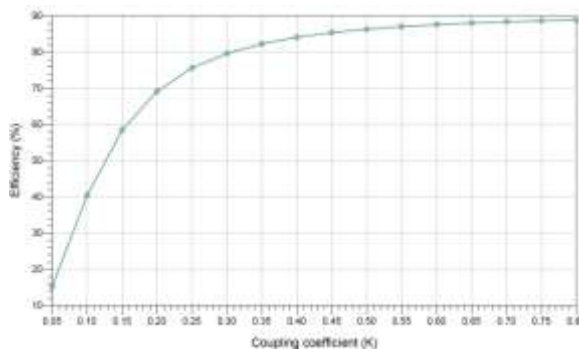

Figure 7: Efficiency Variation with respect to Coupling Coefficient for PP/SP Topologies

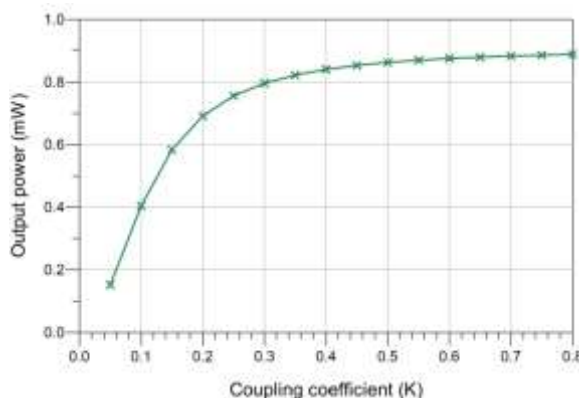

Figure 8: Power delivered to the load verses coupling coefficient for SP topology.

For SS/PS topologies, the secondary network compensated with a series capacitance, the reflected reactance is zero ($Im(Z_r) = 0$) at resonant frequency, the primary inductance value is chosen independently on both the mutual coupling and the load. For PP/SP topologies, the secondary network compensated with a parallel capacitance, the reflected reactance is capacitive and independent on the load at resonant frequency, and the primary inductance value is chosen depending only on the mutual coupling. Although PS topology has resistive reflected impedance represents the load, the parallel capacitance in the primary network depends on both the load and mutual coupling. Therefore, SS topology theoretically is the best choice for biomedical applications since the primary capacitance is independent on both the magnetic coupling and the load. However, in practice the SP topology is widely used due to the ability of the primary circuit (tuned in series resonance) to provide a low impedance load to drive the transmitter coil, whereas the secondary circuit (tuned in parallel resonance) is able to drive a nonlinear rectifier load. The optimum values of C_1 , C_2 and ω to achieve the maximum output power for SP topology has been determined in [16], optimal efficiency with respect to resonant frequency and mutual inductance for SS topology has been determined in [17]. Paper [18] derived an expression called the critical coupling point; beyond this point, the system will be unable to drive the load with maximum efficiency.

10. Conclusion

Wireless power transmission mostly used in implantable biomedical devices as a solution for the limited lifetime of batteries. Power loss caused by heat production is one of the challenges needed to be overcome in developing a system of efficient wireless power transfer. Another challenge that needed to overcome is the difference in coupling coefficients between the two separated coils, which may be reduced because of the presence of air, skin and movements of the eye. This paper provided the power transfer capability expression and analyzed the four topologies (SS_PS_PP_SP) briefly. The SS topology has been chosen as the most suited topology for biomedical implants since primary capacitance is independent on the magnetic coupling in contrast to the three other topologies.

The expressions for the maximized efficiencies are verified with ADS simulator.

References

- [1] M.A. Hannan, S. Mutashar, S. A. Samad and A. Hussain, "Energy harvesting for the implantable biomedical devices: issues and challenges", *Biomedical Engineering Online* 13:79, June 2014.
- [2] G. Manivasagam, D. Dhinasekaran and A.Rajamanickam, "Biomedical Implants Corrosion and its Prevention A Review," *Recent Patents on Corrosion Science*, No. 2, p.p. 40-54 2010.
- [3] C. Wang, G.A. Covic, and O.H. Stielau, "Power Transfer Capability and Bifurcation Phenomena of Loosely Coupled Inductive Power Transfer Systems," *IEEE transactions on industrial electronics*, Vol. 51, No. 1, pp. 148-157, February 2004.
- [4] J. Moradewicz, and M.P. Kazmierkowski, "Contactless Energy Transfer System with FPGA-Controlled Resonant Converter," *IEEE transactions on industrial electronics*, Vol. 57, No. 9, pp. 3181 – 3190, September 2010.
- [5] M. Yang, Y. Wang, X. Zhang, and Liang Li, "Analysis of Reflected Load Model For Inductively Coupled Power Transfer Systems," *IEEE Asia-Pacific Power and Energy Engineering Conf.*, Wuhan, China, 2010.
- [6] M. Kiani, and M. Ghovanloo, "A Figure-of-Merit for Designing High Performance Inductive Power Transmission Links," *IEEE transactions on industrial electronics*, Vol. 60, No. 11, pp. 5292 - 5305, November 2013.
- [7] M. Pinuela, D.C Yates, S. Lucyszyn, and P.D. Mitcheson, "Maximizing DC to Load Efficiency for Inductive Power Transfer," *IEEE transactions on industrial electronics*, Vol. 28, No. 5, pp. 2437 - 2447, May 2013.
- [8] Z.N. Low, , R.A. Chinga, R. Tseng, and J. Lin, "Design and Test of a High Power High-Efficiency Loosely Coupled Planar Wireless Power Transfer System," *IEEE transactions on industrial electronics*, Vol. 56, No. 5, pp. 1801 - 1812, May 2009.
- [9] K.V. Schuylenbergh and R. Puers, "Inductive Powering to Biomedical Systems Basic Theory and Application," *Springer Science and Business Media B.V.*, Book 2009.
- [10] A.P. Sample, B.H. Waters, S.T. Wisdom, and J.R. Smith, "Enabling Seamless Wireless Power Delivery in Dynamic Environments," *Proceedings of IEEE* Vol. 101, No. 6,p.p. 1343–1358, 2013.
- [11] B.H. Waters, A.P. Sample, and J.R. Smith, "Adaptive Impedance Matching For Magnetically Coupled Resonators," in *Progress In Electromagnetics Research Symposium Proceedings*, Moscow, Russia, p.p. 694–701, August 2012.
- [12] C.J. Chen, T.H. Chu, C.-L. Lin, and Z.C. Jou, "A Transfer," *IEEE Transactions on Circuits and Systems II*, Vol. 57, No.7, p.p. 536–540, 2010.
- [13] D. Ahn, S. Hong, "A Transmitter or A Receiver Consisting of Two Strongly Coupled Resonators for Enhanced Resonant Coupling in Wireless Power Transfer," *IEEE transactions on industrial electronics*, Vol. 61, No.3, p.p. 1193–1203, 2014.
- [14] J.T. Boys, G.A. Covic, and A.W. Green, "Stability and Control of Inductively Coupled Power Transfer Systems," *Proceedings of IEE Electronic, Power Applications*, Vol. 147, No. 1, pp. 37–43, January 2000.
- [15] W.B. Kuhn, "Analysis of Current Crowding Effects in Multi turn Spiral Inductors," *IEEE Transactions on Microwave Theory and Techniques*, Vol. 49, No. 1, pp. 31-38, January 2001.
- [16] Y.H. Chao, J.J. Shieh, C.T. Pan, W.C. Shen and M.P. Chen, "A Primary Side Control Strategy for Series-Parallel Loosely Couple Inductive Power Transfer Systems," *Second IEEE Conference on Industrial Electronics and Applications*, 2007.
- [17] Kunwar Aditya, "A Review of Optimal Conditions for Achieving Maximum Power Output and Maximum Efficiency for a Series-Series Resonant Inductive Link," *IEEE transactions on transportation electrification*, p.p. 303-311, Vol. 3, issue 2, June 2017.
- [18] L. Chen, S. Liu, Y. Zhou and T.J. Cui "An Optimizable Circuit Structure for High-Efficiency Wireless Power Transfer," *IEEE transactions on industrial electronics*, p.p. 339-349, Vol. 60, No. 1, January 2013.

Author's biography

Assistant lecturer Suhad Hussein Jasim, Electrical Engineering department, University of technology, Baghdad, Iraq, completed bachelor of engineering (Electrical Engineering) in the year of 1990, University of Baghdad and M.Sc. degree in Electronic Engineering from University of Technology in 2014.