

Design and Implementation of Model Predictive Controller

Hiba Abdulkareem Saleh
heba39566@gmail.com

Thakwan Mohammed Saleem
thakwan59@gmail.com

Computer Engineering Department, Collage of Engineering, University of Mosul

Received: 6/10/2021

Accepted: 7/2/2022

ABSTRACT

The precise position control of a DC servo motor is a major concern in today's control theory. This work presents position following and forecast of DC servo engine utilizing an alternate control technique. Control technique is required to limit and diminish the consistent state error. A model predictive controller MPC is utilized to plan and actualize these prerequisites. Two sorts of controlling techniques are presented in this task. The Active Set Method (ASM), the inside point technique (IIP), and have been utilized as controlling strategies. This work distinguishes and depicts the plan decisions identified with a two sorts of controllers and judicious regulator for a DC servo motor. Execution of these regulators has been confirmed through reproduction utilizing MATLAB/SIMULINK programming. As indicated by the recreation results the Comparisons among ASM, IIP. The tuning strategy was increasingly proficient in improving the progression reaction attributes, for example, decreasing the rise time, settling time and most prominent overshoot in Position control of DC servo motor.

Keywords:

DC servo motor, MPC, ASM, predictive control, IIP.

This is an open access article under the CC BY 4.0 license (<http://creativecommons.org/licenses/by/4.0/>).
<https://rengj.mosuljournals.com>

1. INTRODUCTION

It is very basic to design a control system that would deal with the problem of nonlinear effects that excessively influence the steady operation of our electric engines. DCSM(D.C ServoMotor)straightforward engine which is generally controlled for explicit precise revolution with the guide of an uncommon course of action ordinarily a shut circle input control framework called SERVOMECHANISM. The DCSM has such a significant number of utilizations. A portion of the applications are found in far off controlled toy vehicles for controlling course of movement and it is likewise utilized as the engine which moves the plate of a CD or DVD player. The principle purpose for utilizing a servo is that it gives high accuracy, for example it will just turn as much we need and afterward stop and hang tight for next sign to make further move. This is not normal for a typical electrical engine which turns over pivoting as and when force is applied to it and the revolution proceeds until we switch off the power, MPC and furthermore

called control horizon, retreating horizon or quadric programming control. MPC is an input calculation that utilizes a model to anticipate the future yield of the procedure by taking care of an advancement issue at each time venture to locate the ideal activity of the control by which the anticipated yield of the procedure become close as conceivable to the ideal reference or the objective by limiting the blunder between the reference and the anticipated yield ,MPC is a control innovation which can be set up with the capacity to deal with the issue of streamlining with imperatives, it is utilized in numerous applications, for example, physical procedures automated control framework, petrochemical industry. The center of the MPC controller is to take care of a limited advancement issue on the web so that in the greater part of MPC frameworks the online computational multifaceted nature results executed by a PCs of a superior [1].

2. Literature Review

In 1960, Kalman are right off the bat chipped away at straight MPC. Kalman said that the plant which can be constrained by a direct control can be improved. After that LQR(Linear-Quadratic Regulator) was driven and intended to make a minimization of unconstrained quadratic capacity of information and states. Due to the non-linearity of the most plants that utilized in industry and there is no imperative of it LRQ isn't generally utilized in the business. Then Dynamic Matrix Control (DMC), contrived by Shell Oil , and a related methodology created by ADERSA have very comparative capacities [2].

A versatile MPC procedure Generalized Predictive Control (GPC) has additionally gotten significant consideration [3]. In 2003, Both Ruth Millman and Joseph Davison maintained the algorithm New programming solution (QP) squared control Updated time bellow of the effective group algorithm (active group) based directly on multiplication methods Lacran multiplier And equations of determinants, and various of this method The primary-secondary of the middle point (inner double inner point) [4].

In 2009, was carried out by researchers P.D.Dimitrion, et al. , represent real-time predictive control based on the MPC An embedded microcontroller using SoC technology within a chip ,the chip as an assistant processor performs calculations to calculate the optimal point in the programming solution Using the logarithmic numbering system (LNS) to represent the numbers [5]. In 2010, D. Wilson et al., represented constructive predictive control On the model with simple requirements using both matrix field programmable gates Spartan 3, Digital Signal Processing Chips (DSP chips), Microcontroller Microcontroller (PC) for designing embedded applications [6]. In 2011, J.L.Jenez, E.C.Kerrigan represents quadratic programming in a matrix of programmable field gates for linear control For linear operations, the specifiers within the model-based predictive control have been used Parallel Tubing Technology to Reduce Quadratic Programming Time [7].

In 2013, Vihangkumar V. Naik, et al. design Model Predictive Control of DC Servomotor using Active Set Method[8]. In 2013 ,J.L.Jerez, P.J.Goulart, represent the model-based predictive control on the gates matrix Virtex 6 programmable, using fast gradient method to solve quadratic programming (QP) with the use of a decimal point(fixed point numbers) [9]. In 2016, Zidong Wang et al.,design Robust model predictive control under redundant channel

transmission with applications in networked DC motor systems[10]. In any case, writing study shows that few control procedures were proposed for the DCSM. In 2016 researchers et al.,design Model Predictive Climate Control of a Swiss Office Building [15].

3. D.C. Servo Motor Analysis

In this research, the dc servo motor has been consider as a linear SISO (Single Input Single Output) system having third order transfer function. The speed and position of a DC servo engine can be fluctuated by controlling the field transition, the armature opposition or the terminal voltage applied to the armature circuit. The three most basic position control strategies are field obstruction control, armature voltage control, and armature opposition control. Here the armature voltage control has been considered in light of the fact that servo engine is less delicate to change in field current. In force condition field motion is adequately huge. Consequently, every little change in armature current, I_a , turns out to be a lot of touchy to the servo engine, here consider the armature controlled DC servo engine framework.The structure of the Armature controlled DC servo motor is shown in Figure 1 [16].

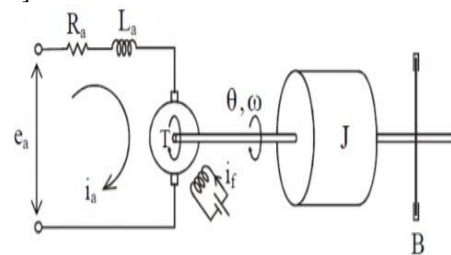

Fig. 1 Armature controlled DC servo motor[16].

Mathematical model for DC motor is[16]:

$$\frac{\Theta(s)}{E_a(s)} = \frac{K_{TM}}{S[(L_a S + R_a)(J S + B) + K_{TM} K_b]} \quad (1)$$

Where R_a , L_a , J , and B , are the servo motor armature resistance and inductance, torque friction constant, and flux motor density respectively. While, E_a , I_a , E_b , T , and θ , are the armature voltage and current, motor voltage, torque, and motor displacement respectively, in order to simplify the calculations, K_{TM} , K_b (The motor torque and motor constants respectively), are considered having the same values and replaced by K .

4. MPC Problem Analysis

Model predictive control is a model based optimal control method that solves the constrained finite-horizon optimization problem by predicting the future behavior of system variables using the current state of the system at each sampling time. The predictions along the prediction and control horizon are calculated in order to minimize a cost function that generally depends on error and control signal. Only the first element of the obtained optimal control sequence is applied to the real system and the whole algorithm is repeated by measuring or observing the system output at the next sampling time. In the method, the cost function to be optimized depends on error and control signals along prediction and control horizon, respectively .

The optimal control sequence that minimizes the cost function is obtained along the control horizon by using the prediction of system states. Only the first element of the sequence is applied to the real system and the whole algorithm is repeated by measuring or estimating the system output at the next sampling time. The receding horizon control strategy provides the system a feedback and in this way, it is possible to compensate the modeling errors and the disturbances that affect to the system [17], [18]. Basically, a MPC loop consists of a system model, a cost function and a optimization tool. There are two essential parameters in the loop: Prediction horizon N_p and control horizon N_c . Whereas the prediction horizon refers to the length of horizon to be predicted, the control horizon defines the number of elements in the candidate control sequence to be applied to the system during the prediction horizon. Therefore, the inequality $N_c \leq N_p$ must always be satisfied and the elements after the N_c^{th} of candidate control sequence must be equal to the N_c^{th} element of the sequence. is shown in Figure. 2 The basic structure of MPC [19], [20].

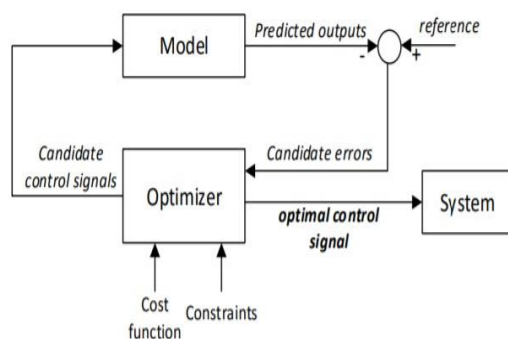

Fig. 2 The basic structure of the model predictive control[21].

4.1. Discrete-time MPC State Space Analysis

In this section, fundamental thoughts and terms about the discrete model prescient control will be introduced. The reason for using the discrete state space analysis is that for the facilities and the wide range of computational flexibilities available in the discrete analysis. The same state space analysis discussed in the previous section will be repeated with discrete time domain and more details. For straightforwardness, we start our examination by accepting that the basic plant is a solitary information and single-yield framework, depicted by [22]:

$$x_m(K + 1) = A_m x_m(K) + B_m u(K), \quad (2)$$

$$y = C_m x_m(K) \quad (3)$$

where u is the controlled variable or info variable; y is the cycle yield; and $x_m(K)$ is the state variable vector with accepted measurement $n1$. Note that this plant model has $u(k)$ as its info. Subsequently, we need to change the model to suit our plan reason in which an integrator is installed. Note that an overall plan of a state-space model has an immediate term from the info signal $u(k)$ to the yield $y(k)$ as :

$$y(K) = C_m x_m(K) + D_m u(K) \quad (4)$$

In any case, because of the rule of subsiding skyline control, where a current data of the plant is needed for expectation and control, we have verifiably accepted that the info $u(k)$ can't influence the yield $y(k)$ simultaneously. In this way, $D_m = 0$ in the plant model. Taking a distinction procedure on the two sides of (4), we get that

$$\begin{aligned} x_m(K + 1) - x_m(K) &= A_m(x_m(K) - x_m(K - 1)) \\ &+ B_m(u(K) - u(K - 1)) \end{aligned} \quad (5)$$

Let us denote the difference of the state variable by

$$\begin{aligned} \Delta x_m(K + 1) &= X_m(K + 1) - x_m(K), \\ \Delta x_m(K) &= x_m(K) - x_m(K - 1) \end{aligned} \quad (6)$$

And the difference of the control variable by:

$$\Delta u(K) = u(K) - u(K - 1) \quad (7)$$

These are the additions of the factors $x_m(K)$ and $u(K)$. with this change, the distinction of the state-space condition is:

$$\Delta x_m(K + 1) = A_m \Delta x_m(K) + B_m \Delta u(K). \quad (8)$$

Note that the contribution to the state model is $\Delta u(K)$. The subsequent stage is ro interface $\Delta x_m(K)$ to the yield $y(K)$. To do as such, another state variable vector is picked to be

$$\begin{aligned} x(K) &= [\Delta x_m(K)^T \ y(K)]^T, \\ y(K + 1) - y(K) &= C_m(x_m(K + 1) - x_m(K)) \end{aligned} \quad (9)$$

$$= C_m A_m \Delta x_m(K) + C_m B_m \Delta u(K) \tag{10}$$

Putting together (9) with (10) leads to the following state-space model:

$$\begin{bmatrix} \Delta x_m(K+1) \\ y(K+1) \end{bmatrix} = \begin{bmatrix} A_m & 0_m^T \\ C_m A_m & 1 \end{bmatrix} \begin{bmatrix} \Delta x_m(K) \\ y(K) \end{bmatrix} + \begin{bmatrix} B_m \\ C_m B_m \end{bmatrix} \Delta u(K) \tag{11}$$

$$y(K) = \begin{bmatrix} c \\ 0_m 1 \end{bmatrix} \begin{bmatrix} \Delta x_m(K) \\ y(K) \end{bmatrix} \tag{12}$$

Where $0_m = [0 \ 0 \ \dots \ 0]$ the trio (A,B,C) is known as the model, which will be utilized in the plan of prescient control

4.2. MPC of State and Output Variables inside One Optimization Window

Over the detailing of the numerical model, the subsequent stage in the plan of a prescient control framework is to figure the anticipated plant yield with the future control signal as the movable factors. This expectation is depicted inside an improvement window. This part will inspect in detail the enhancement inside this window. Here, we accept that the current time is k_i and the length of the enhancement window is N_p as the quantity of tests. For straightforwardness, the instance of single-information and single-yield frameworks is viewed as first, at that point the outcomes are stretched out to multi-input and multi-yield frameworks.

Expecting that at the inspecting moment k_i , $k_i > 0$, the state variable vector $x(k_i)$ is accessible through estimation, the state $x(k_i)$ gives the current plant data. The more broad circumstance where the state isn't straightforwardly estimated will be talked about later. The future control direction is meant by

$$\Delta u(k_i), \Delta u(k_i + 1), \dots, \Delta u(k_i + N_c - 1), \tag{13}$$

where N_c is known as the control skyline directing the quantity of boundaries used to catch the future control direction. With given data $x(k_i)$, the future state factors are anticipated for N_p number of tests, where N_p is known as the forecast skyline. N_p is additionally the length of the streamlining window. We indicate the future state factors as

$$x(k_i + 1 | k_i), x(k_i + 2 | k_i), \dots, x(k_i + m | k_i), \dots, x(k_i + N_p | k_i) \tag{14}$$

where $x(k_i+m | k_i)$ is the anticipated state variable at k_i+m with given current plant data $x(k_i)$. The control skyline N_c is picked to be not exactly (or equivalent to) the forecast skyline N_p . In light of the state-space model (A, B, C), the future state factors are determined successively utilizing the arrangement of future control parameters[31]:

$$\begin{aligned} x(K_i + 1 | K_i) &= A_x(K_i) + B\Delta u(K_i) \\ x(K_i + 2 | K_i) &= A_x(K_i + 1 | K_i) + B\Delta u(K_i + 1) \\ &= A^2 x(K_i) + AB\Delta u(K_i) + B\Delta u(K_i + 1) \end{aligned}$$

$$\begin{aligned} x(K_i + N_p | K_i) &= A^{N_p} x(K_i) + A^{N_p-1} B\Delta u(K_i) \\ &\quad + A^{N_p-2} B\Delta u(K_i + 1) \\ &\quad + \dots + A^{N_p-N_c} B\Delta u(K_i + N_c - 1). \end{aligned} \tag{15}$$

From the predicted state variables, the predicted output variable are, by substitution

$$\begin{aligned} y(K_i + 1 | K_i) &= CAx(K_i) + CB\Delta u(K_i) \\ y(K_i + 2 | K_i) &= CA^2x(K_i) + CAB\Delta u(K_i) \\ &\quad + CB\Delta u(K_i + 1) \\ y(K_i + 3 | K_i) &= CA^3x(K_i) + CA^2B\Delta u(K_i) \\ &\quad + CAB\Delta u(K_i + 1) \\ &\quad + CB\Delta u(K_i + 2) \end{aligned}$$

$$\begin{aligned} &\dots \\ &\dots \\ &\dots \\ y(K_i + N_p | K_i) &= CA^{N_p}x(K_i) + CA^{N_p-1}B\Delta u(K_i) \\ &\quad + CA^{N_p-3}B\Delta u(K_i + 1) \\ &\quad + \dots \\ &\quad + CA^{N_p-N_c}B\Delta u(K_i + N_c - 1). \end{aligned} \tag{16}$$

Note that all anticipated factors are defined as far as present status variable data $x(k_i)$ and the future control movement $\Delta u(k_i+j)$, where $j = 0, 1, \dots, N_c - 1$. Define vectors:

$$Y = [y(K_i + 1 | K_i) \ y(K_i + 2 | K_i) \ y(K_i + 3 | K_i) \ \dots \ y(K_i + N_p | K_i)]^T \tag{17}$$

$$\Delta U = [\Delta u(K_i) \ \Delta u(K_i + 1) \ \Delta u(K_i + 2) \ \dots \ \Delta u(K_i + N_c - 1)]^T \tag{18}$$

where in the single-information and single-yield case, the component of Y is N_p and the element of ΔU is N_c . We gather (17) and (18) together in a minimized network structure as:

$$Y = F_x(K_i) + \Delta U \tag{19}$$

Where

$$F = \begin{bmatrix} CA \\ CA^2 \\ CA^3 \\ \vdots \\ CA^{N_p} \end{bmatrix} \quad \Phi \\
 = \begin{bmatrix} CB & 0 & 0 & \dots & 0 \\ CAB & CB & 0 & \dots & 0 \\ CA^2B & CA\Phi B & CB & \dots & 0 \\ \vdots & \vdots & \vdots & \vdots & \vdots \\ CA^{N_p-1}B & CA^{N_p-2}B & CA^{N_p-3}B & \dots & CA^{N_p-N_c}B \end{bmatrix} \quad (20)$$

For a given set-point signal $r(k_i)$ at test time k_i , inside a forecast skyline the goal of the prescient control framework is to bring the anticipated yield as close as conceivable to the set-point signal, where we accept that the set point signal remaining parts consistent in the advancement window.

This goal is then made an interpretation of into a plan to track down the 'best' control boundary vector ΔU with the end goal that a blunder work between the set-point and the anticipated yield is limited. Accepting that the information vector that contains the set-point data is:

$$E_s^T = \overbrace{[1 \ 1 \ \dots \ 1]}^{N_p} r(k_i), \quad (21)$$

We characterize the expense work J that mirrors the control unbiased as

$$J = (R_s - Y)^T(R_s - Y) + \Delta U^T \hat{R} \Delta U \quad (22)$$

The structure of MPC is shown in Figure 3.

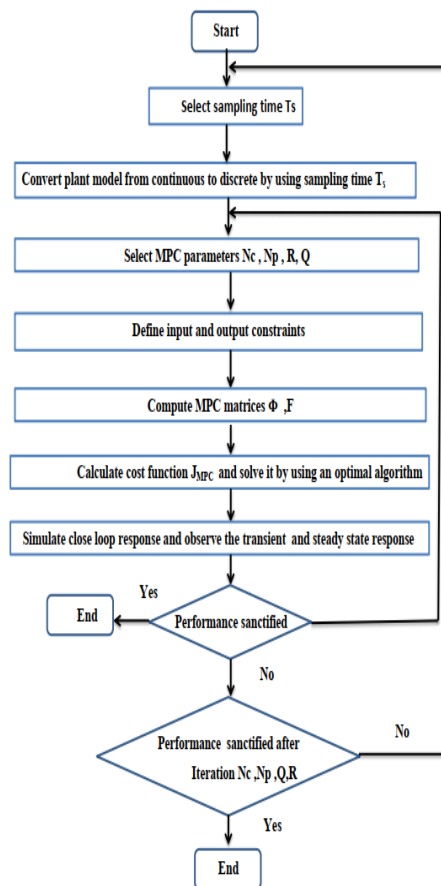

Fig. 3 Model predictive controller design flowchart.

4.3 Active Set Methods(ASM)

The idea of active set methods is to define at each step of an algorithm a set of constraints, termed the working set, that is to be treated as the active set. The working set is chosen to be a subset of the constraints that are actually active at the current point, and hence the current point is feasible for the working set then the algorithm proceeds to move on the surface defined by the working set of constraints to an improved point at each step of the active set method, an equality constraint problem is solved, If all the Lagrange multipliers $\lambda_i \geq 0$, then the point is a local solution to the original problem if, on the other hand, there exists a $\lambda_i < 0$, then the objective function value can be decreased by relaxing the constraint i (i.e., deleting it from the constant equation) [18],[19].

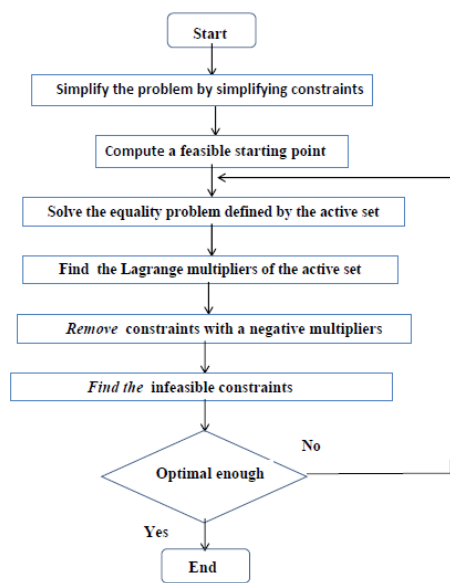
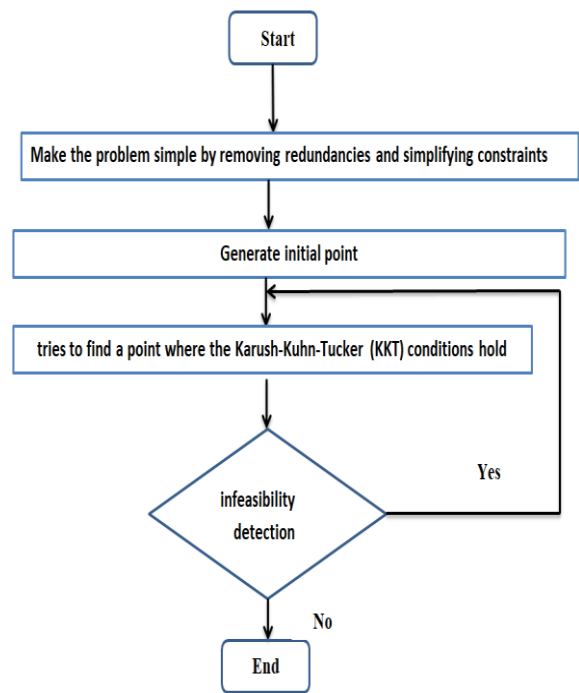

Fig . 4 ASM flowchart.

4.4. Infeasible Interior Point (IIP)

Interior point methods are guaranteed to converge, within a given accuracy, much faster than QP algorithms. Inside point strategies tackle issues iteratively to such an extent that all repeats fulfill the imbalance limitations rigorously. They approach the arrangement from either the inside or outside of the doable district yet never lie on the limit of this region ,to set up the conditions empowering us to plan the inside point techniques by defining a Lagrangian capacity, the general theory on compelled enhancement has been used and setting up Karush-Kuhn-Tucker (KKT) conditions for the QP's we wish to settle [20],[21].



owchart.

5. D.C servo motor simulation

The D.C. servo motor of the plant has been implemented with the parameters shown in the table 1 and simulated using MatLab19b m. files and Simulink tool box

Table 1: D.C. servo motor parameters [22]

Parameters	Value
J: Moment of inertia of the motor(Kgm ² /rad)	0.016
B: Viscous friction coefficient (Nm/(rad/sec))	0.1
L: Armature inductance (H)	0.01
R: Armature resistance (Ω)	1
K _{TM} : Electromotive force constant (Vs/rad)	0.04
K _b : Back emf constant of motor (volt/(rad/sec)	0.04

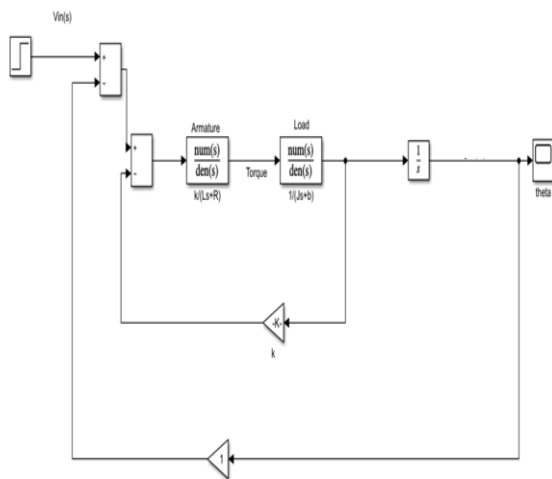

Fig. 6 Simulink schematic of DC motor control system.

The m. files codes utilized to present the operation of the D.C servo motor plant, transfer function. The Simulink step response illustrated in Figure 7 and The step response characteristic of the position of dc servo motor such as the peak overshoot, the settling time, and the rise time are illustrated table 2

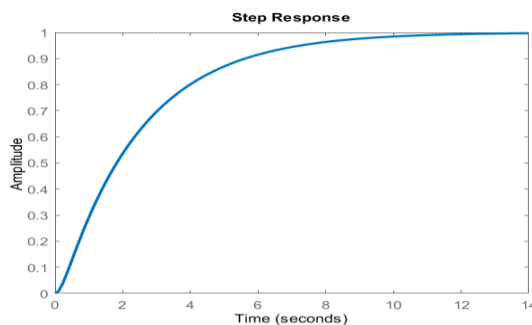

Fig. 7 Step response of the position of D.C. servo motor using matlab m file.

Table 2: Characteristics of the step response of D.C servo motor

Characteristics	Value
Rise time	5.2061 sec
Settling time	9.4213 sec
Overshoot	0 %

6. MPC Design and Simulation

The MPC design has been designed in both ASM and IIP algorithms with the parameters shown in table 3 and have been represented via two MatLab19b techniques, the m. files ,the Simulink tool box as well as LabVIEW simulation toolbox as illustrated in Figures 8,9,10

Table 3:The parameters that used to design MPC controller in ASM and IIP

Parameter	Value
Sampling time	0.01 sec
Prediction horizon	20
Control horizon	4
Input weight	0.1
Output weight	10
Input constraint	$-10 < u < 10$
Output constraint	$0 < y < 1$

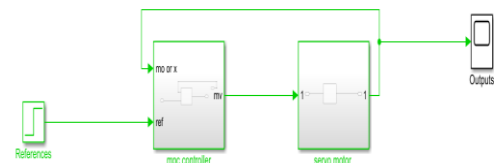

Fig. 8 Simulink model of DC Servo Motor control system based on MPC controller

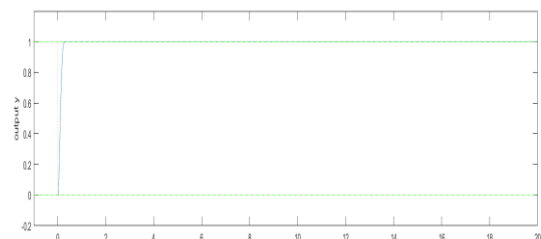

Fig.. 9 The step response of both MPC controller algorithms using m.file.

From table 4 the performance parameters of the MPC controller that designed in both ASM and IIP are in the same values expected the execution time of both algorithms that show that the designed MPC controller in the IIP algorithm has less execution time compared with the MPC controller that designed in ASM algorithms, this is because the Active set algorithm will perform a calculation to find feasible starting point ,this requires more math operations and more time . As well as the step response of the designed MPC controller, shows the effect of the constrain in the output when ($0 < y < 1$).

Table 4:The performance parameters by designing MPC controller

Performance parameters	algorithm IIP	ASM algorithm
Settling time (sec)	0.2387	0.2387 sec
Rise time (sec)	0.1489 sec	0.1489 sec
Overshoot	0%	0%
Execution time(period=1/fc)	40.5469	26.8438
Cost function value	2.1296e-09	2.1296e-09

Comparing the performance of the D.C servo motor with MPC controller and the performance of the D.C servo motor without a controller there is an enhancement in the performance of the D.C servo motor when the MPC controller has been used to control it as shown in table 5.

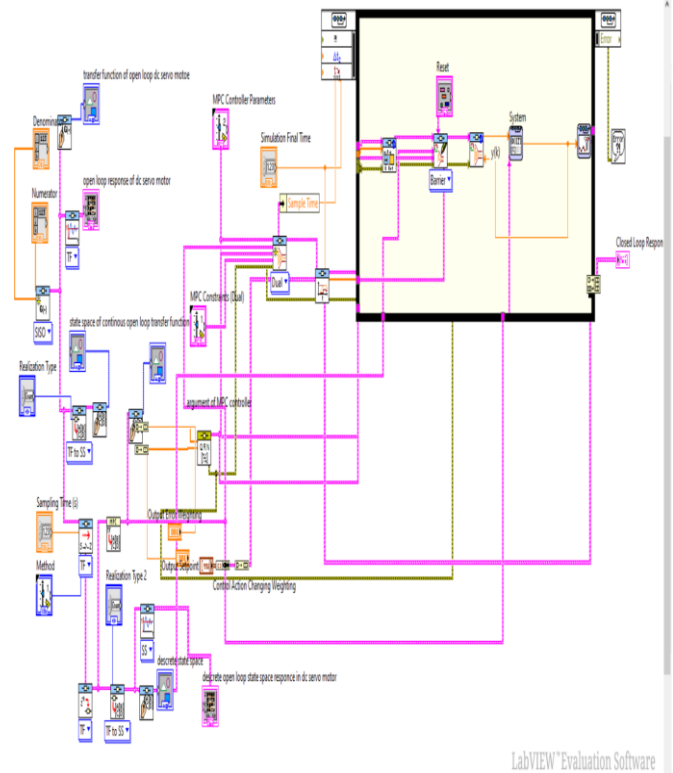

Fig.. 10 Designing MPC controller by using simulation in LabVIEW program

Table 5:The performance enhancement by MPC controller

Performance parameters	algorithm IIP	ASM algorithm	servo motor
Settling time	0.2387 sec	0.2387 sec	9.4213 sec
Rise time	0.1489 sec	0.1489 sec	5.2061 sec
Overshoot	0%	0%	0%

6.1.The effect of changing the sampling time(T_s) in the performance of MPC controller.

The sample time is a key concept in model predictive control. The effect of changing the sampling time in the performance of MPC controller when prediction horizon ($N_p=20$), control horizon($N_c=4$), output weight ($y_o=10$) Input weight ($y_u =0.1$) is shown in Figure 12 and Table 6.

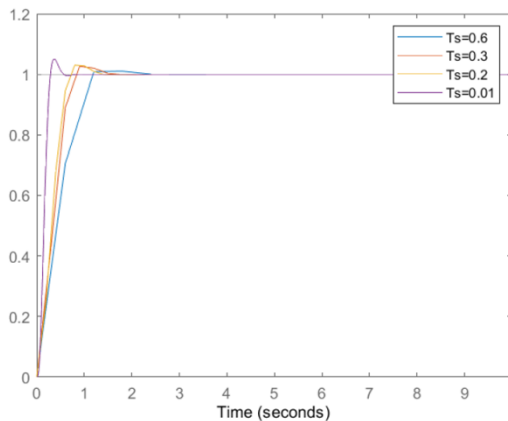

Fig . 11 Effect of changing sampling time value

Table 6: Effect of changing Ts in MPC controller

Sampling time (sec)	Rise time (sec)	Settling time (sec)	Overshoot
0.6	0.9001	1.1433	1.0331
0.3	0.5525	1.2054	2.6474
0.2	0.4875	1.0874	3.0444
0.01	0.1718	0.4783	5.0361

From the previous result that illustrated in Figure 12 and the table 6 that shows when the value of sampling time become small the overshoot parameter will be increased but the rise time and settling decreased.

When Ts turns to low value, the evaluation attempt also implementation period increment effectually as the MPC maximization case is evaluated rather generally. Rapid Ts will need a more estimation horizon to maintain the estimation period steady.

Nevertheless, as discussed in the Prediction Horizon section, more prediction horizons direct to further judgment variables as well extra restrictions those put the optimization problem more difficult also further multiplexed to evaluate hence, the best selection is a balance of response with calculations attempt.

6.2.The effect of changing the prediction horizon in the performance of MPC controller.

In Model Predictive Control, the expectation skyline, Np is likewise a significant thought.The performance of MPC controller effected when changing the prediction horizon when sampling time (Ts=0.01sec),control horizon(Nc=4),output

weight (yo=10) Input weight (yu =0.1) as shown in Figure 13 and table 7

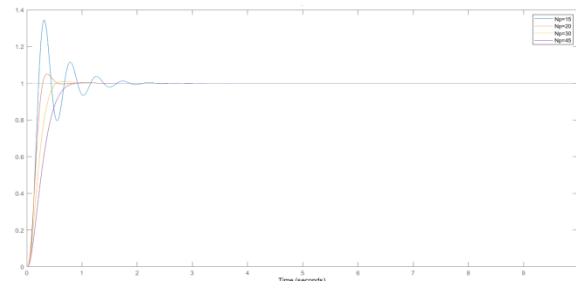

Fig .12 Effect of changing prediction horizon

Table 7:The Effect of changing Np in MPC controller

Prediction horizon	Rise time (sec)	Settling time (sec)	Overshoot
15	0.1246	1.6092	37.5226
20	0.1616	0.4790	8.7928
30	0.2448	0.4796	2.5333
45	0.2803	0.6545	0

The previous result shows that when the prediction horizon increased the overshoot decreased but the rise time and settling time increased . However, larger Np values lead to more decision variables which lead to a larger optimization problem the dimensions of many matrices in the MPC optimization problem are proportional to Np with longer execution times and higher memory requirement and QP solution time increase.

6.3.The effect of changing the control horizon in the performance of MPC controller.

Control horizon (Nc) is the number of samples within the prediction horizon where the MPC controller can affect the control action. The control horizon falls between 1 and the prediction horizon Np .The performance of MPC controller effected when changing the prediction horizon when sampling time (Ts=0.01sec),prediction horizon(Np=20),output weight (yo=10) and Input weight (yu =0.1) is show in Figure 13 and table 8.

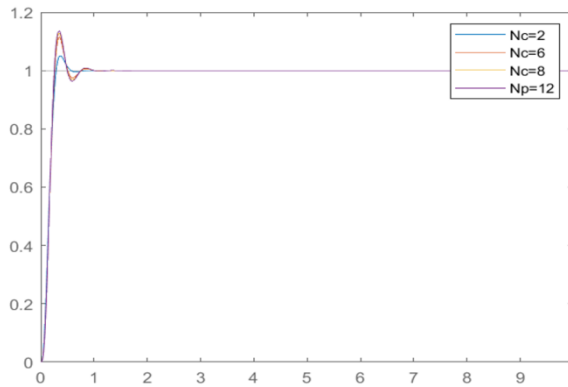

Fig .13 The effect of changing the control horizon in MPC

Table 8: Effect of changing Nc in MPC controller

Control horizon	Rise time (sec)	Settling time (sec)	Overshoot
2	0.1718	0.4783	0
6	0.1616	0.4790	8.7928
8	0.1540	0.6702	12.7250
12	0.1523	0.6761	13.5717

Little Nc implies less factors to register in the QP addressed at each control span, which advances quicker calculations.

In the event that the plant incorporates delays, $N_c < N_p$ is fundamental. Something else, some MV moves probably won't influence any of the plant yields before the finish of the forecast skyline. Small Nc promotes an internally stable controller.

7. comparison between the responses of the control system based on simulink and LabVIEW programs

The MPC design has been designed in both MatLab19b Simulink tool box and LabVIEW simulation toolbox with the parameters shown in table 3 and the m. files, the as well as as illustrated in Figures 14 and ,15

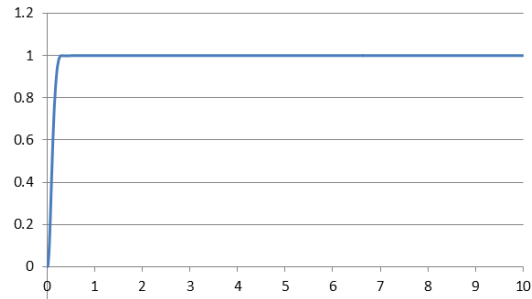

Fig. 14 The step response of MPC controller using labview simulation tool box.

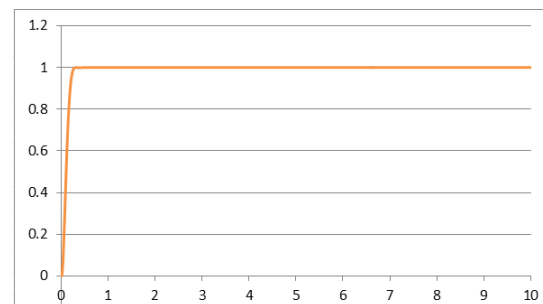

Fig. 15 The step response of MPC controller using MatLab19b Simulink tool box.

Table 9: the responses of the control system based on simulink and LabVIEW programs.

Performance parameters	SIMULINK IN MATLAB	labview simulation tool box.
Settling time	0.2387 sec	0.2395sec
Rise time	0.1489 sec	.1482 sec
Overshoot	0%	0%

8 .CONCLUSION

The MPC controller are designed in this paper to increase the performance of DC Servo Motors. Various methods, such as ASM and IIPare used to design MPC controller by MatLab19b and labview simulation tool box. Several metrics are used to evaluate the performance of the designed optimal controllers, including rise time, maximum overshoot, settling time, execution time, and cost.

8. References

- [1] C. E. García, D. M. Prett, and M. Morari, Model predictive control: Theory and practice—A survey, *Automatica*, vol. 25, no. 3, pp. 335–348, May 1989
- [2] Y. Ding, L. Wang, Y. Li, and D. Li, Model predictive control and its application in agriculture: A review, *Comput. Electron. Agric.*, vol. 151, pp. 104–117, Aug. 2018.
- [3] S. Chidrawar and B. Patre, Generalized Predictive Control and Neural Generalized Predictive Control, no. 13, p. 21, 2008
- [4] .R. Milman and E. J. Davison, Evaluation of a new algorithm for model predictive control based on non-feasible search directions using premature termination, in *42nd IEEE International Conference on Decision and Control (IEEE Cat. No.03CH37475)*, Maui, Hawaii, USA, 2003, vol. 3, pp. 2216–2221,
- [5] L. Bleris and M. V. Kothare, LNS architectures for embedded model predictive control processors, in *Proceedings of the 2004 international conference on Compilers, architecture, and synthesis for embedded systems - CASES '04*, Washington DC, USA, 2004, p. 79,
- [6] J. Currie, D.I. Wilson, Lightweight Model Predictive Control intended for embedded applications, *Proceedings of the 9th International Symposium on Dynamics and Control of Process Systems (DYCOPS 2010)*.
- [7] E. C. Kerrigan, J. L. Jerez, G. A. Constantinides, and K.-V. Ling, Model predictive control for deeply pipelined field-programmable gate array implementation: algorithms and circuitry, *IET Control Theory Appl.*, vol. 6, no. 8, pp. 1029–1041, May 2012,
- [8] V. V. Naik, D. N. Sonawane, D. D. Ingole, and D. Ginoya, Model Predictive Control of DC Servomotor using Active Set Method, in *2013 IEEE International Conference on Control Applications (CCA)*, Hyderabad, India, Aug. 2013, pp. 820–825,
- [9] L. Bleris and M. V. Kothare, LNS architectures for embedded model predictive control processors, in *Proceedings of the 2004 international conference on Compilers, architecture, and synthesis for embedded systems - CASES '04*, Washington DC, USA, 2004, p. 79,.
- [10] Y. Song, Z. Wang, D. Ding, and G. Wei, Robust model predictive control under redundant channel transmission with applications in networked DC motor systems: Robust Model Predictive Control Under Redundant Channel, *Int. J. Robust Nonlinear Control*, vol. 26, no. 18, pp. 3937–3957, Dec. 2016,
- [11] D. Sturzenegger, D. Gyalistras, M. Morari, and R. S. Smith, Model Predictive Climate Control of a Swiss Office Building: Implementation, Results, and Cost–Benefit Analysis, *IEEE Trans. Control Syst. Technol.*, vol. 24, no. 1, pp. 1–12, Jan. 2016
- [12] S. He, Z. Chen, and X. Gao, Parameter Solving of DC Servo Motor PID Controller Based on Improved Firefly Algorithm, in *2018 3rd International Conference on Robotics and Automation Engineering (ICRAE)*, Guangzhou, Nov. 2018, pp. 136–140
- [13] D. S. M. Girirajkumar, “APPLICATION OF ANT COLONY OPTIMIZATION ALGORITHM FOR SPEED CONTROL OF A REAL TIME D.C. SHUNT MOTOR,” p. 2.
- [14] J. B. Rawlings, D. Q. Mayne, and M. M. Diehl, *Model predictive control: theory, computation, and design*, 2nd edition. Madison, Wisconsin: Nob Hill Publishing, 2017.
- [15] N. S. Rathore, D. P. S. Chauhan, and V. P. Singh, Tuning of PID controller for position control of DC servo motor using Luus-Jaakola Optimization, in *2015 International Conference on Computer, Communication and Control (IC4)*, Indore, India, Sep. 2015.
- [16] P. E. Orukpe, MODEL PREDICTIVE CONTROL FUNDAMENTALS, *Niger. J. Technol.*, vol. 31, no. 2, p. 10
- [17] J. A. Rossiter, *Model-based predictive control: a practical approach*. Boca Raton, Fla.: CRC Press, 2004
- [18] N. Goldberg and S. Leyffer, Active Set Method for Second-Order Conic-Constrained Quadratic Programming, p. 21.
- [19] S. Leyffer, The Return of the Active Set Method, p. 4.
- [20] Q. Guo, L. Jiang, J. Gao, X. Wang, and X. Xiao, Research on reliability optimization of weapon system based on Generalized Lagrange multipliers, in *2011 International Conference on System science, Engineering design and Manufacturing informatization*, Guiyang, China, Oct. 2011, pp. 17–19,
- [21] J. J. Moré and G. Toraldo, Algorithms for bound constrained quadratic programming problems, *Numer. Math.*, vol. 55, no. 4, pp. 377–400, Jul. 1989.
- [22] S. He, Z. Chen, and X. Gao, “Parameter Solving of DC Servo Motor PID Controller Based on Improved Firefly Algorithm,” in *2018 3rd International Conference on Robotics and Automation Engineering (ICRAE)*, Guangzhou, Nov. 2018, pp. 136–140

تصميم وتنفيذ نموذج المتحكم التنبؤي

ذكوآن محمد سليم
thakwan59@gmail.com

هبة عبد الكريم صالح
heba39566@gmail.com

جامعة الموصل - كلية الهندسة - قسم هندسة الحاسوب

المخلص

يعد التحكم في الموضع المحدد لمحرك مؤازر DC مشكلة كبيرة في فرضية التحكم الحالية. يقدم هذا العمل متابعة الموقف والتنبؤ بمحرك مؤازر DC باستخدام تقنية تحكم بديلة. تقنية التحكم مطلوبة للحد من خطأ الحالة المتسق وتقليله. يتم استخدام وحدة تحكم تنبؤية نموذجية MPC لتخطيط وتحقيق هذه المتطلبات الأساسية. يتم تقديم نوعين من تقنيات التحكم في هذه المهمة. تم استخدام استراتيجيات المجموعة الديناميكية ASM ، وتقنية النقطة الداخلية IIP ، كاستراتيجيات تحكم. يتميز هذا العمل وبصور قرارات الخطة المحددة بنوعين من وحدات التحكم والمنظم الحكيم لمحرك مؤازر يعمل بالتيار المستمر. تم تأكيد تنفيذ هذه الهياكل التنظيمية من خلال الاستنساخ باستخدام برمجة MATLAB / SIMULINK. كما يتضح من نتائج الاستجمام ، فإن المقارنات بين ASM و IIP. كانت استراتيجيات الضبط بارعة بشكل متزايد في تحسين سمات تفاعل التقدم ، على سبيل المثال ، تقليل وقت الصعود ، ووقت الاستقرار ، وأبرز تجاوز في التحكم في موضع محرك سيرفو DC. توفر تقنية المنظم الإدراكي النموذجي أفضل تنفيذ وتعميم لتقنية MPC المتاحة على وحدات التحكم الأخرى

الكلمات الدالة:

محرك سيرفو DC ، MPC ، ASM ، تحكم تنبؤي ، IIP.