



## A Comparative Study of Perturb and Observe (P&O) and Incremental Conductance (INC) PV MPPT Techniques at Different Radiation and Temperature Conditions

Marwan E. Ahmad\*, Ali H. Numan , Dhari Y. Mahmood 

Electrical Engineering Dept., University of Technology-Iraq, Alsina'a Street, 10066 Baghdad, Iraq.

\*Corresponding author Email: [eee.19.09@grad.uotechnology.edu.iq](mailto:eee.19.09@grad.uotechnology.edu.iq)

### HIGHLIGHTS

- Extract the maximum output power from photovoltaic (PV) panels under different solar radiation and temperature conditions.
- A comparative study between perturb and observe (P & O) and incremental conduction (INC) algorithms.
- The boost converter design increases the voltage of the photovoltaic panel by controlling the duty cycle.
- The performance of the INC algorithm is better than that of P & O.

### ABSTRACT

The biggest challenge in the solar system is to extract the maximum output power from photovoltaic (PV) panels under different solar radiation and temperature conditions. This paper presents a comparative study between perturb and observe (P & O) and incremental conduction (INC) algorithms. These are the most popular algorithms for tracking solar PV panels and extracting the maximum power point (MPP) under different climate conditions. The studied PV system and the MPPT techniques have been investigated by simulation using MATLAB/Simulink. The simulation includes a boost converter, which increases the PV panel voltage by controlling the duty cycle. The obtained results show that the P & O performance close to MPP under constant test conditions (STC) is better than the variable conditions due to oscillation. In contrast, the performance of the INC algorithm is better than P & O in terms of speed to reach MPP, accuracy, and quality under changes in radiation and temperature conditions.

### ARTICLE INFO

**Handling editor:** Ivan A. Hashim

**Keywords:**

Solar PV panel; PV Characteristics; STC; Boost converter; MPPT; P&O Algorithm  
INC Algorithm

## 1. Introduction

Electric energy is essential in the daily life of people. The demand for electric power increases due to the increase in population and industrial development in the world. The generation of electric power increased from 17.3 trillion kilowatts in 2005 to 24.4 trillion kilowatts in 2015 and could reach 33.3 trillion kilowatts in 2030. Most of the electrical energy is generated from fossil fuels, that is, from non-renewable energy. With the increase in energy demand, economic and environmental problems have emerged, such as greenhouse gas emissions such as carbon dioxide (CO<sub>2</sub>), Environmental contamination, and probable fossil fuel depletion. To secure the future of electricity, the globe is moving towards developing renewable energy sources [1, 2].

In light of technological development, the world has turned to renewable energy sources (RES); perhaps the most important is solar energy. Clean, sustainable energy can be trusted to form a microgrid that helps the power grid solve problems. Increasing energy demand and some environmental and economic problems resulting from fossil fuels [3,4]. Therefore, it requires quality in controlling its capabilities and the integrity of its requirements to maintain continuity of power supply [5]. Despite the benefits of PV systems, the PV system is considered to be of low efficiency due to its dependence on the power of the PV panel. The PV panel is affected by environmental factors such as radiation and temperature, which leads to energy loss and low efficiency and its impact on the electrical characteristics of voltage-current and voltage-power, thus on the connected load [6,7]. To improve the efficiency of the PV system, techniques are used for maximum power point tracking (MPPT) in the PV panels with the

converter circuit, which is done by adjusting the duty cycle (D) of the boost converter, So that the input power matches a load of the PV system. so The task of MPPT is to extract the maximum possible power from the PV array under various conditions [8]. Many kinds of literature examined the use of (MPPT) techniques to improve the efficiency of the photovoltaic system, especially the techniques proposed in this paper (P&O and INC). It showed the technical efficiency of INC in terms of performance, fast-tracking time, and less fluctuation, such as [6],[7],[16],[18]. This paper presents a study of the advantages of the most common MPPT algorithms (INC) and (P&O), comparing the two methods on the MATLAB / SIMULINK platform, based on a 17 kW PV array and boost converter. INC algorithm proves to be more efficient compared to P&O in terms of fast-tracking time, low oscillation, and good performance in various weather conditions.

## 2. System Model

The proposed system model consists of a PV array of about 17 kW, with a boost converter and an MPPT. Figure 1 shows the proposed system model, and the parts of the system will be explained in detail below.

### 2.1 PV panels

A solar cell is a semiconductor material that converts solar radiation into electricity. Depending on semiconductor material and technology, the solar cell can generate 0.5 to 0.8v. These voltages are considered insufficient for applications, so these cells are connected in series or parallel of a single frame forming the solar panel. The equivalent circuit of a solar cell consists of a single diode or double diode and a current source ( $I_{ph}$ ), in addition to a series resistance ( $R_s$ ) of low value and parallel resistance ( $R_{sh}$ ) of high value. It may be neglected. In this paper, a single diode is used because it is simple in analysis and more efficient [9-11]. Figure 2 illustrates the equivalent circuit of a single-valve solar cell.

The equation of current for a solar panel circuit according to the given equivalent circuit is:

$$I_{PV} = I_{Ph} - I_o \left[ \exp\left(\frac{q \times V_{PV} + I_{PV} \times R_s}{N_s A K T_a}\right) - 1 \right] + I_{sh} \tag{1}$$

and

$$I_{sh} = \frac{V_{PV} + I_{PV} R_s}{R_{sh}} \tag{2}$$

Where:  $I_{PV}$ : Current of PV cell, A,  $I_{Ph}$ : Photo-current generated by the photoelectric effect (Amper),  $I_o$ : Reverse saturation current,  $I_{sh}$ : Shunt current (A),  $q$ : Electron charge equal to  $1.6 \times 10^{-19}$  coulomb,  $R_s$ : Series resistance ( $\Omega$ ),  $R_{sh}$ : Shunt of resistance ( $\Omega$ ),  $V_{PV}$ : Output voltage from PV, panel, A: Ideality factor of the diode, K: Boltzmann’s constant equals  $1.3805 \times 10^{-23}$  J/k,  $N_s$ : Number of cells connected in series,  $T_a$ : Operating temperature (K).

Based on the PV panel model, a PV array consisting of two series and (28) panels in parallel that can be constructed and simulated on Matlab. Measuring the properties of the solar cells in terms of voltage and power curves (P-V), current, and voltage curves (I-V) depends on the solar panel parameters used in Table 1.

The voltage and power curve at standard conditions STC is shown in Figure 3. Figure 4 shows the energy dependence of solar panels on irradiance, where the irradiance changes 1000 W/m<sup>2</sup>, 800 W/m<sup>2</sup>, 600 W/m<sup>2</sup>, 400 W/m<sup>2</sup>, and 200 W/m<sup>2</sup> at the same temperature at 25 °C, and with it, the MPP changes at each radiation.

**Table 1:** Parameters of solar array 305 sun power at STC

Parameter	Value
Maximum power (Pmax)	305 W
Rated Voltage Vmp	54.7 V
Rated Current Imp	5.58 A
Open Circuit Voltage Voc	64.2 V
Short Circuit Current Isc	5.96 A
Solar Cells	96

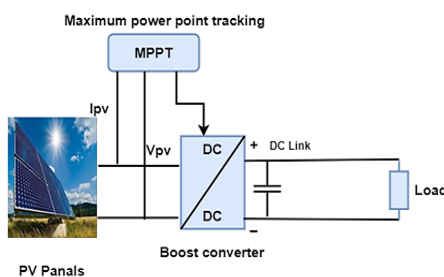

**Figure 1:** Block diagram of the system

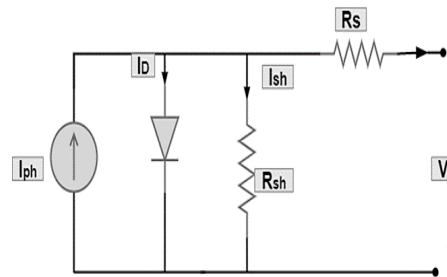

**Figure 2:** Single-diode PV equivalent circuit

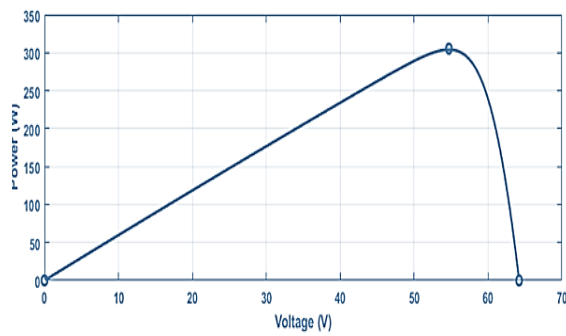

Figure 3: P-V characteristics of the PV panel under STC

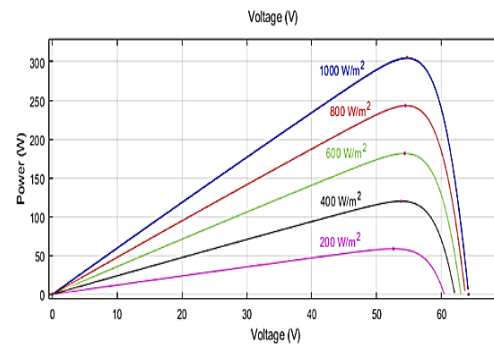

Figure 4: P-V characteristics of the PV panel under variable irradiation

## 2.2 MPPT Algorithms

Climatic conditions and accompanying changes such as temperature and radiation affect power generation in a PV array, leading to a chipping phenomenon in the generation. With an increasing temperature, the Voc voltage decreased, while solar radiation increased the ISC current of the short circuit. A single point in the PV array can operate at a maximum loading force called the Maximum Power Point (MPP). The site of this point is non-linear and affected by temperature changes and solar radiation, which leads to its deflection, so the photoelectric system should use the MPPT maximum power point tracking algorithm to ensure the efficiency High for system and continuous operation without cutting [12,13].

Figure 5 shows the characteristics curve of open-circuit voltage and short circuit current I-V and the power curve for open-circuit voltage P-V. It references the maximum MPP power point of the PV array. MPPT algorithm can be defined as a technique used to track the maximum power point in a PV array and maintain the output power's stability under different temperature and solar radiation changes. There are many algorithms used for this purpose. Each algorithm has different characteristics and advantages in terms of simplicity, complexity, speed of proximity of MPP, vibration, electronic and computational cost [14,15]. P&O and INC algorithms are considered the most popular in use due to their excellent features, including ease of implementation, MPP proximity, and response speed [16]. The two algorithms will be explained in the section below.

### 2.2.1 Perturb and Observe (P&O)

The P&O technique is commonly used to extract power near a PV array. The advantages of this technique are that it is easy to implement, has excellent performance, and can be used in low-cost systems. The principle of this technique's work is based on the disturbance of current or voltage in the PV array by decreasing or increasing the "On" time of the pulse period at each cycle and its effect on the output power. In addition, it involves periodic monitoring, comparison of frequencies in voltage or current, and controlling the reduction and increase of the voltage or even the current. The period can be increased or decreased depending on the formula  $\Delta P/\Delta V$ . If the value  $\Delta P/\Delta V$  is more significant than zero, the algorithm decreases the "On" period.

On the other hand, suppose the value  $\Delta P/\Delta V$  is less than zero. In that case, after several iterations, the algorithm increases the "On" period until it reaches a constant value close to the PV array's maximum power point (MPP). Hence, it requires current and voltage sensors. Figure 6 provides a flowchart of the P&O algorithm [17,18].

### 2.2.2 Incremental Conductance Algorithm (INC)

The INC algorithm has been proposed to overcome some shortcomings of the (P&O) algorithm, such as steady-state error, rapid response to variable solar radiation, and convergence velocity. One advantage of this algorithm is its combination of speed and accuracy, while the P&O algorithm must choose between speed and accuracy. This is achieved by deriving the relationship  $P \times V$  concerning voltage or current. MPP can be calculated using the  $dp/dv$  and  $-I/v$  relationship, as shown in the following derivation.

$$P = V \times I \tag{3}$$

$$\frac{dP}{dv} = I + V \cdot \frac{dI}{dv} \tag{4}$$

Or

$$\frac{dP}{dI} = V + I \cdot \frac{dv}{dI} \tag{5}$$

From the calculation  $\Delta I$  and  $\Delta V$  to depend on the values I and V, the MPP values can be inferred from the following expressions:

$$\frac{\Delta I}{\Delta V} > \frac{-I}{V} \text{ The point of operation is the left of MPP}$$

$\frac{\Delta I}{\Delta V} = \frac{-I}{V}$  The point of operation is exactly at MPP

$\frac{\Delta I}{\Delta V} < \frac{-I}{V}$  The point of operation is to the right of MPP

According to these comparisons, the algorithm increases or decreases the voltage in the PV array. Figure 7 illustrates an INC algorithm's flowchart [19-21].

### 3. Boost Converter

The step-up converter is also called a boost converter because the output voltage exceeds the input voltage. It consists of two semiconductors (IGBT or MOSFET and the diode), an inductor for energy storage, a filter composed of a capacitor, load resistance, and the DC source. The MOSFET changes the duty cycle (D), and the power transfer is modified from the input source to the load. As shown in Figure 8, the MOSFET works to change the duty cycle (D), and the power transfer is modified from the input source to the load. Figure 9 shows waveforms of the Boost converter [22,23]. Using Faraday's law, the relationship between the output and input voltage of the boost converter can be found by using equation 6: [24,25].

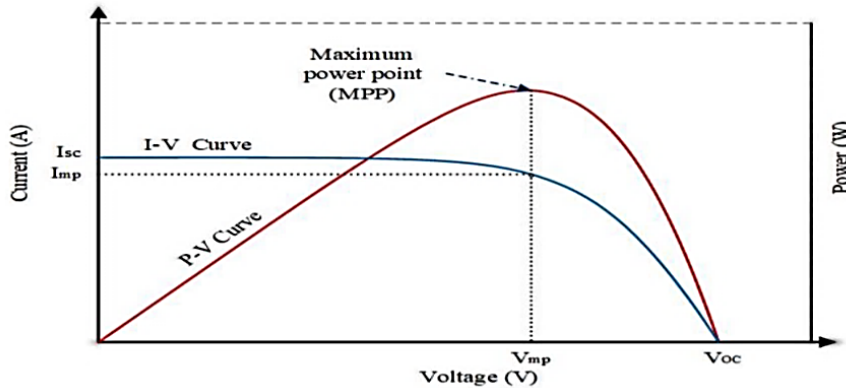

Figure 5: I-V and P-V output characteristics

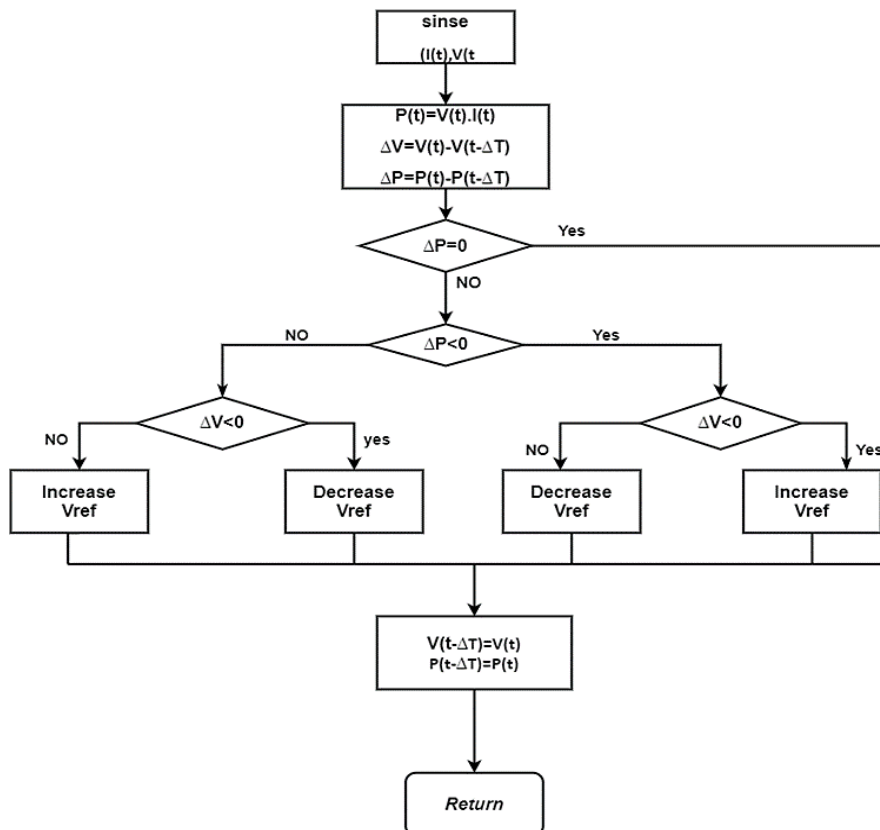

Figure 6: Flowchart of P&O Algorithm

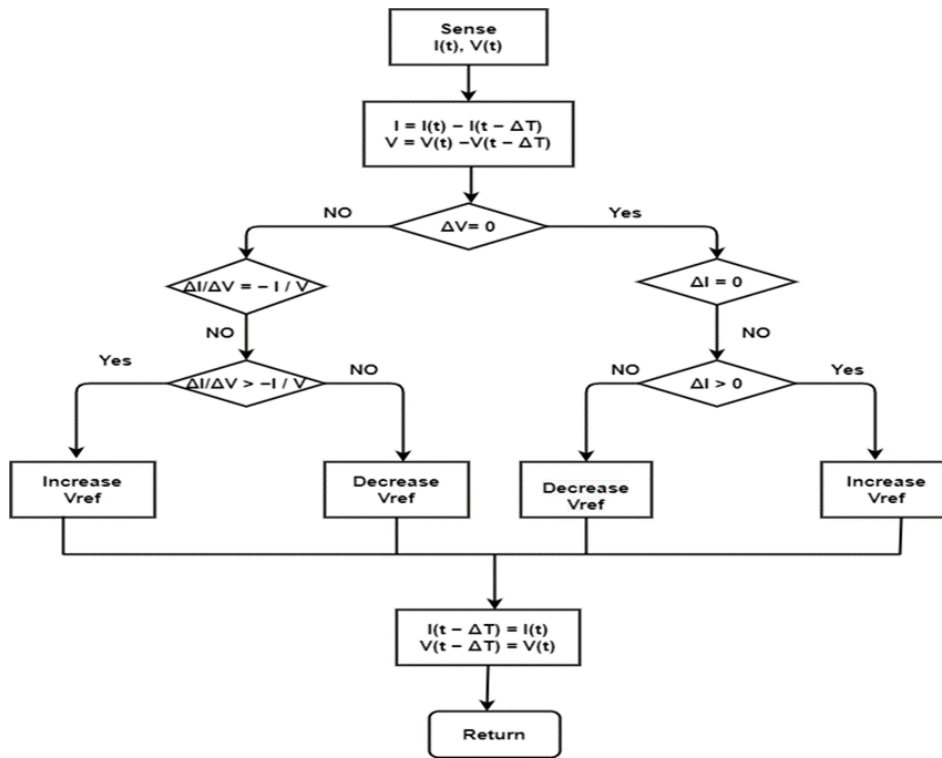

Figure 7: Flowchart of INC algorithm

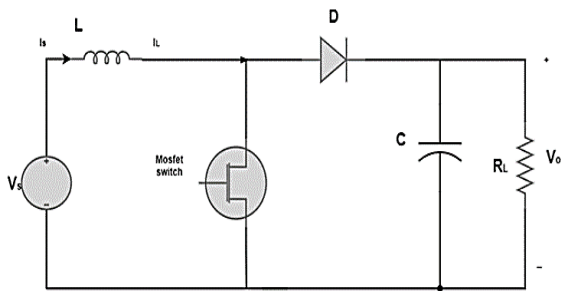

Figure 8: Boost converter circuit

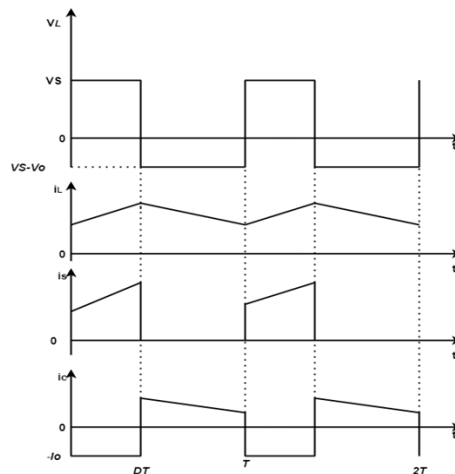

Figure 9: Boost converter waveforms

$$V_s \cdot DT = (V_o - V_s)(1 - D) \tag{6}$$

Where:  $V_s$ : Input voltage,  $V_o$ : Output voltage of DC-DC boost converter,  $D$ : Duty cycle, and the DC voltage transfer function:

$$M_v = \frac{V_o}{V_s} = \frac{1}{1-D} \tag{7}$$

Where:  $M_v$ : Transfer function of DC voltage. The minimum value of the inductor can be calculated in the boost converter:

$$L_{min} = \frac{(1-D)^2 D R_L}{2f_s} \tag{8}$$

where:  $f_s$ : Switching frequency,  $R_L$ : Load resistance.

The operation of the boost converter in continuous conduction mode (CCM) means that the output current does not reach zero when the switch is turned off.  $L \gg L_{min}$  where  $L_{min}$  is the boundary inductance, Calculates the minimum value of the capacitor:

$$C_{min} = \frac{D V_o}{V_r R_L f_s} \quad (9)$$

Where:  $V_r$ : Voltage ripple. To Calculation of load resistance:

$$P_{in} = V_s I = \frac{V_o^2}{R_L} \quad (10)$$

Where:  $P_{in}$ : Input power,  $I$ : Input current

Using the equations from (6) to (10), the boost converter is designed in Table 2.

#### 4. Simulation

The MATLAB / SIMULINK platform is used to create the simulation designs. The simulation of the proposed system is performed using the P&O algorithm and then the INC algorithm based on the parameters of Tables 1 and 2. Figure 10 shows a complete system designed in Simulink.

**Table 2:** Design specifications of the boost converter

Parameters	Values
Maximum power ( $P_{max}$ )	17.1kW
Output Voltage ( $V_o$ )	218.5 v
Output voltage ripple ( $\Delta V_o$ )	0.02 v
Switching frequency ( $f_s$ )	10kHz
Load resistance ( $R$ )	2.83 $\Omega$
Inductance ( $L$ )	5mH
Output filter capacitance	12mf

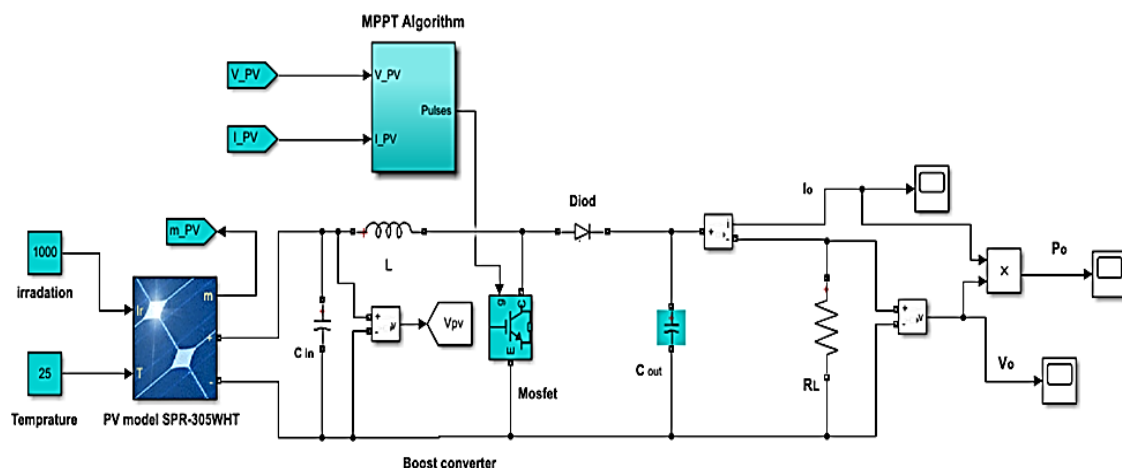

**Figure 10:** Complete system designed in Simulink

#### 5. Results and Discussion

Based on the datasheet presented in Tables 1 and 2, in which two panels were connected in series and 28 panels in parallel, the output voltage was 109.4 volts, the current was 156.24, and the output capacity was about 17kW. These results were used as a simulation for a DC power system consisting of a PV array and Boost converter, in addition to the load ( $R$ ). To keep the maximum power generated by the solar panels, two technologies, MPPT P&O and INC, use and compare them. The results were implemented in two scenarios as follows:

**Scenario I:** Under standard test condition (STC) ( $1000\text{W/m}^2$ ,  $25^\circ\text{C}$ ), Figures 11 to 13 show the voltage, current, and power curves using the INC and P&O algorithm under standard conditions STC

Simulation results show the performance of the PV system using INC and P&O algorithms STC, that is, when the temperature is constant and so is the radiation, as the P&O algorithm quickly finds MPP. Still, it oscillates at MPP due to oscillation in the duty cycle, as shown in Figure 14. In contrast, the INC algorithm finds MPP after a time delay, but there are few oscillations in the duty cycle, as in Figure 12. Optimizing the duty cycle can improve the performance of the P&O algorithm, making MPP tracking Best.

**Scenario II:** under partial shading conditions ( $500\text{W/m}^2$ ,  $32^\circ\text{C}$ ), In this case, the system is tested in three cyclic states. The first is periodic ( $t = 0$  to  $t = 0.6$ ) the radiation is reduced to  $800\text{W/m}^2$  with a constant temperature (STC) of  $25^\circ\text{C}$ , the second

cycle irradiance ( $t = 0.6$  to  $1.2$ ) which gradually decreases to  $400 \text{ W/m}^2$  by degree. The temperature changes until reaching  $20^\circ\text{C}$ . At the third cycle ( $t = 1.2$  to  $t = 2$ ), the radiation level returns to rise until it reaches a maximum of  $1000 \text{ W/m}^2$  with the temperature gradually changing to  $32^\circ\text{C}$ . Figures 15, 16, and 17 show the curve results for tracking the maximum power of the PV array under different conditions using the INC and P&O algorithm in addition to radiation and temperature changes.

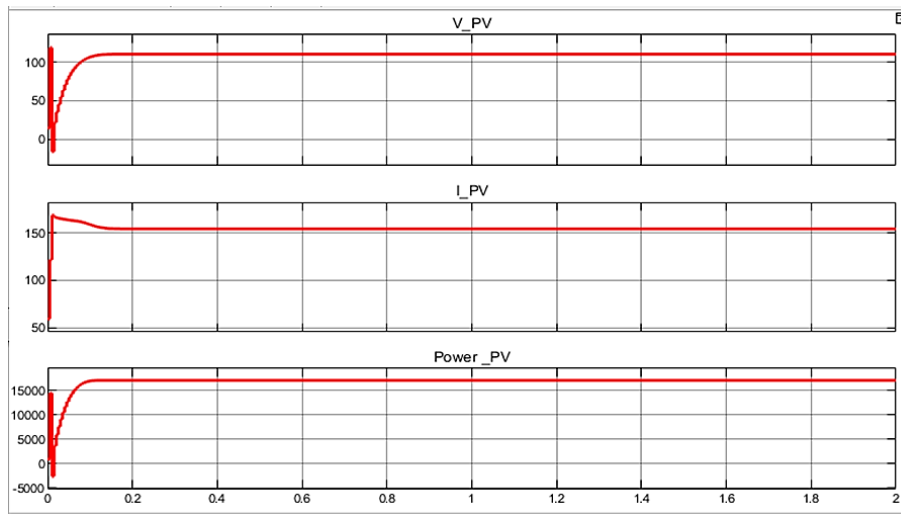

Figure 11: Voltage, current, and power output from the PV array under STC using the INC algorithm



Figure 12: The duty cycle of the INC algorithm

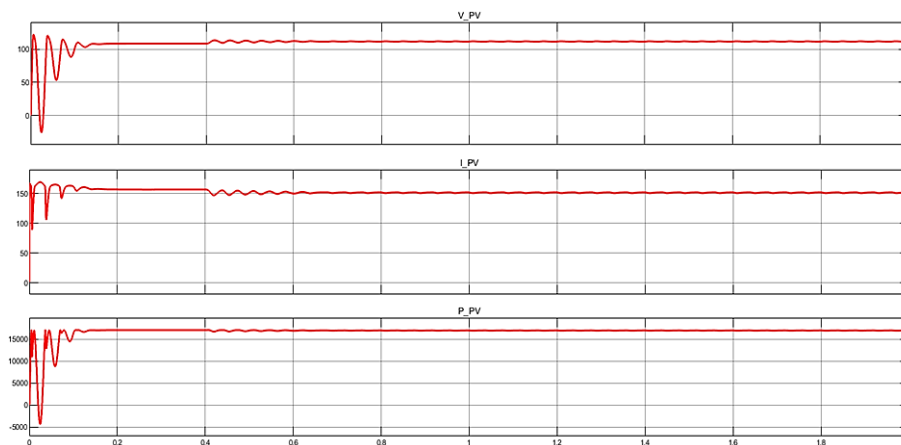

Figure 13: Voltage, current, and power output from the PV array under STC using the P&O algorithm

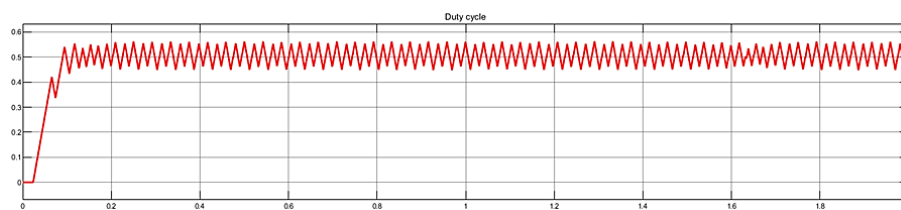

Figure 14: The duty cycle of P&O Algorithm



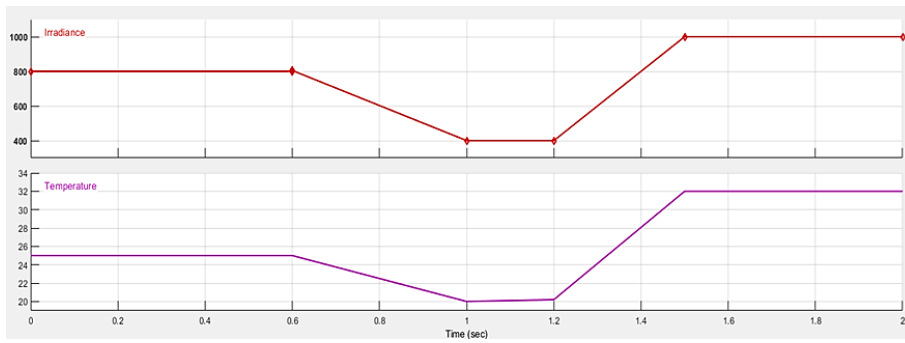

Figure 15: Radiation and temperature changes

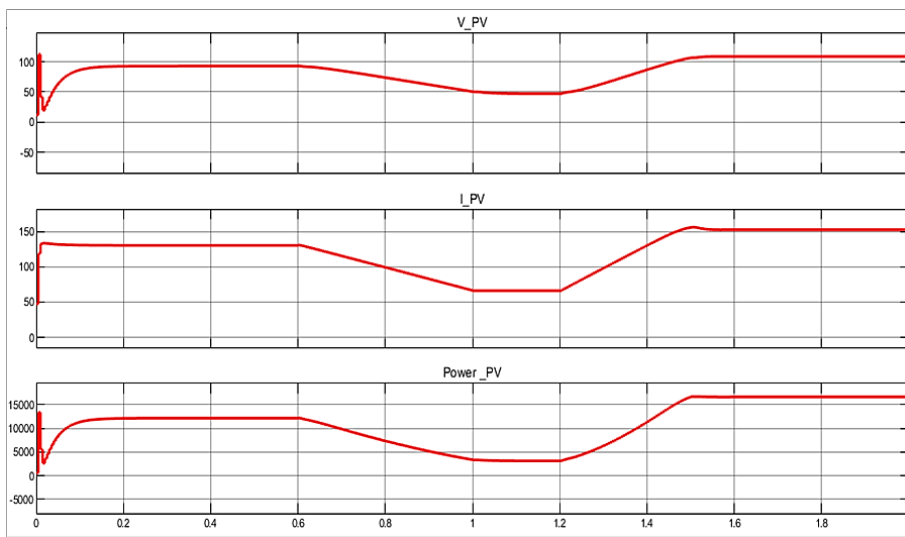

Figure 16: Voltage, current, and power output from the PV array under variable test conditions using the INC algorithm

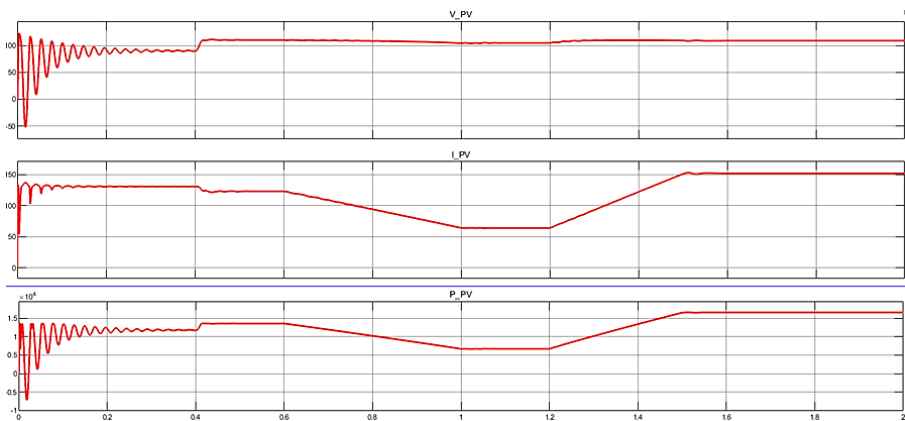

Figure 17: Voltage, current, and power output from the PV array under variable test conditions using the P&O algorithm

### 6. Conclusion

The work includes using MPPT technology to extract the maximum power from a 17 kW PV array under standard radiation, temperature (STC), and variable conditions. The algorithms used for this purpose are P&O and INC, and a study was conducted on the way the two algorithms work and the use of the boost converter to change the duty cycle and match The output power with the load. Based on the MATLAB /SIMULINK platform, the results were compared in the two methods. Results showed that P&O technology has the advantage of working near MPP despite slight oscillation but also works under static conditions (STC) better than variable conditions. As for INC technology, it is accurate and fast in tracking MPP compared to P&O and successfully reducing oscillation in various changing conditions, so it can be concluded that the INC algorithm works better than the P&O Algorithm.



### Author contribution

All authors contributed equally to this work.

### Funding

This research received no specific grant from any funding agency in the public, commercial, or not-for-profit sectors.

### Data availability statement

The data that support the findings of this study are available on request from the corresponding author.

### Conflicts of interest

The authors declare that there is no conflict of interest.

### References

- [1] M. Kumar, Design and Simulation of Grid Connected PV System, M.Sc. thesis, IIT Univesity, Electr. Eng. , 2016.
- [2] D. Bacha: Burger, B.:Etxeberria-Otadui, I.:Martins, J., S. :Picaul. PVs in Microgrids. IEEE Ind. Electron. Mag., 9 (2015) 33–46.
- [3] P. Ray, Microgrid : Operation, Control, Monitoring and Protection. Springer Verlag Berlin Heidelberg. 2020
- [4] W. Xiao, Photovoltaic Power System. in Photovoltaic Power System. John Wiley & Sons, USA. 2017
- [5] K. Sasi Kottayil, 2021, Smart Microgrids book, Taylor & Francis Group, USA.
- [6] F. E. Tahiri, K. Chikh, M. Khafallah, A. Saad, Comparative study between two Maximum PowerPoint Tracking techniques for photovoltaic system, Proc. Int. Conf. Elect. Infor. Tec., (2016) 107–112.
- [7] K. Jain, M. Gupta, A. Kumar. Bohre, Implementation and Comparative Analysis of P&O and INC MPPT Method for PV System, India. Int. Conf. Power. Electron., (2018) 1–6. <https://doi.org/10.1109/IICPE.2018.8709519>
- [8] A. N. M. Mohammad, M. A. M. Radzi, N. Azis, S. Shafie, An enhanced adaptive perturb and observe technique for efficient maximum power point tracking under partial shading conditions, Appl. Sci., 10 (2020) 3912. <https://doi.org/10.3390/app10113912>
- [9] A.Y. Mohammed, Modeling and Simulation of 1MW Grid Connected Photovoltaic System, M.Sc. Thesis. Dep. Electr. Eng., University of Technology-Iraq, 2017.
- [10] T. S. Kishore, S. D. Kaushik, Y. V. Madhavi, Modelling, Simulation and Analysis of PI and FL Controlled Microgrid System , IEEE. Int. Conf. Intell. Comput. Commun., (2019) 1–8. <https://doi.org/10.1109/ICECCT.2019.8869379>
- [11] A. F. Hussein, H. A. R. Akkar, Intelligent controller Design based on wind-solar system, Eng. Technol. J., 39 (2021) 326–337. <https://doi.org/10.30684/etj.v39i2a.1761>
- [12] C. B. N. Fapi, P. Wira, M. Kamta, A Fuzzy Logic MPPT Algorithm with a PI Controller for a Standalone PV System under Variable Weather and Load Conditions, Int. Conf. App. Smart Sys., (2018) 24–25. <https://doi.org/10.1109/ICASS.2018.8652047>
- [13] M. Q. Ali, M. S. Tapou, H. A. Dhahad. Performance evaluation of Photovoltaic Panels by a Proposed Automated System Based on Microcontrollers, Eng. Technol. J., 39 (2021) 9–21. <https://doi.org/10.30684/etj.v39i1a.1634>
- [14] T. V. Muni, D. Priyanka, S. V. N. L. Lalitha, Fast acting MPPT algorithm for soft switching interleaved boost converter for solar photovoltaic system, J. Adv. Res. Dynam. Contr. Sys., 10 (2018) 996–1003.
- [15] S. D. Al-Majidi, M. F. Abbod, H. S. Al-Raweshidy, A novel maximum power point tracking technique based on fuzzy logic for photovoltaic systems, Int. J. Hydrogen. Energy, 43 (2018) 14158–14171 <https://doi.org/10.1016/j.ijhydene.2018.06.002>
- [16] S. Saravanan, N. R. Babu, Maximum power point tracking algorithms for photovoltaic system - A review, Renew. Sust. Energ. Rev., 57 (2016) 192–204. <https://doi.org/10.1016/j.rser.2015.12.105>
- [17] F. L. Tofoli, D. De. Ca. Pereira, W. J. De. Paula, Comparative study of maximum power point tracking techniques for photovoltaic systems, Int. J. Photoenergy., 2015 . <http://dx.doi.org/10.1155/2015/812582>
- [18] M. H. Mahmood , I. I. Ali , Od. A. Ahmed, Comparative Study of Perturb & Observe, Modified Perturb & Observe and Modified Incremental Conductance MPPT Techniques for PV Systems, Eng. Technol. J., 38 (2020) 478–490. <https://doi.org/10.30684/etj.v38i4a.329>
- [19] R. I. Putri, S. Wibowo, M. Rifa, Maximum power point tracking for photovoltaic using incremental conductance method, Energy. Procedia., 68 (2015) 22–30. <https://doi.org/10.1016/j.egypro.2015.03.228>

- [20] B. Singh, B. Verma, P. K. Padhy, Study of PO and INC PV MPPT techniques for different environment conditions, IEEE Int. Conf. Power. Int. J. Electr. Power. Energy. Syst., 3 (2018) 165–169. <https://doi.org/10.1109/ICPEICES.2018.8897479>
- [21] S. Lyden, M. E. Haque, Maximum Power Point Tracking techniques for photovoltaic systems: A comprehensive review and comparative analysis, Renew. Sustain. Energy Rev., 52 (2015) 1504–1518. <https://doi.org/10.1016/j.rser.2015.07.172>
- [22] K. S. Faraj , J. Farhood, Analysis and comparison of DC-DC boost converter and interleaved DC-DC boost converter, Int. J. Eng. Technol. 38 (2020) 622-635. <https://doi.org/10.30684/etj.v38i5A.291>
- [23] M. H. Rashid, Power Electronics Handbook, Butterworth- Heinemann, 2018.
- [24] A.Chandramouli, V. Sivachiadambaranathan, Design and analysis of a photovoltaic system with a DC-DC boost converter, Int. Conf. Comput. Commun. Methods., (2019) 59–67. <https://doi.org/10.1109/ICCMC.2019.8819836>
- [25] K. Basaran, N. S. Cetin, Designing of a fuzzy controller for grid connected photovoltaic system's converter and comparing with PI controller, IEEE. Int. Conf. Renew. Energy. Res. Appl., (2017) 102–106. <https://doi.org/10.1109/ICRERA.2016.7884437>