



Analysis and Comparison of DC-DC Boost Converter and Interleaved DC-DC Boost Converter

Karrar S. Faraj ^{a*}, Jasim F. Hussein^b

^a Electrical Engineering Department, University of Technology, Iraq. 30736@student.uotechnology.edu.iq

^b Electrical Engineering Department, University of Technology, Iraq. 3705@uotechnology.edu.iq

*Corresponding author.

Submitted: 24/05/2019

Accepted: 06/06/2019

Published: 25/05/2020

KEY WORDS

Boost Converter,
Interleaved Boost
Converter, Continuous
Current Mode, MPPT,
Input Current ripple,
Output Voltage ripple.

ABSTRACT

The step-up converters are widespread use in many applications, including powered vehicles, photovoltaic systems, continuous power supplies, and fuel cell systems. The reliability, quality, maintainability, and reduction in size are the important requirements in the energy conversion process. Interleaving method is one of advisable solution for heavy-performance applications, its harmonious in circuit design by paralleling two or more identical converters. This paper investigates the comparison performance of a two-phase interleaved boost converter with the traditional boost converter. The investigation of validation performance was introduced through steady-state analysis and operation. The operation modes and mathematical analysis are presented. The interleaved boost converter improves low-voltage stress across the switches, low-input current ripple also improving the efficiency compared with a traditional boost converter. To validate the performance in terms of input and output ripple and values, the two converters were tested using MATLAB/SIMULINK. The results supported the mathematical analysis. The cancelation of ripple in input and output voltage is significantly detected. The ripple amplitude is reducing in IBC comparing with a traditional boost converter, and the ripple frequency is doubled. This tends to reduce output filter losses, and size.

How to cite this article: K. S. Faraj and J. F. Hussein, "Analysis and comparison of DC-DC boost converter and interleaved DC-DC boost converter," Engineering and Technology Journal, Vol. 38, Part A, No. 05, pp. 622-635, 2020.

DOI: <https://doi.org/10.30684/etj.v38i5A.291>

This is an open access article under the CC BY 4.0 license <http://creativecommons.org/licenses/by/4.0>.

1. Introduction

DC/DC converters are very essential units that are used in renewable power conversion units as electronic operating systems for power applications. Most renewable outlets, as well as photovoltaic (PV) systems and wind energy, have the least voltage output. They demand booster circuits to provide sufficient voltage at the output side. They demand booster circuits to provide sufficient voltage at the output side. The PV current ripple magnitude is an important factor for maximum power point tracking (MPPT) [1]. As electronic operating systems for power applications, the high current ripples can embarrass MPPT algorithm program. Lead to produce more oscillation around the maximum power point (MPP). This will disturb the system performance during the MPP tracking

point [1]. For such systems, it is preferred to have a switching strategy with a faster transient response. As well, minimize ripples and switching losses to a low value as possible.

The conventional boost converter static gain capacity is limited. The high-output voltage essentially can be handled by a high duty ratio. Thus, the switch device will remain under ON state Long-term intervals. If the boost current is high, the diode can suffer from the reverse-recovery phenomenon. Therefore, it is important to do not rely solely on high-voltage duty ratio applications [2, 3].

The necessity converter requirements are to be capable of a high voltage conversion ratio with low ripple value. [4] In relation, a high switching frequency is preferred to reduce the passive component size. The suitable, efficient and more effective power conversion process is being subject to many researchers [5-8]. Based on the conventional DC-DC boost converter, theology has proposed several step-up DC-DC optimization techniques improving key issues such as efficiency, voltage gain, and power quality management.

One of the most important techniques is to increase the voltage without the need for severe duty ratios. Figure 1 proposes a possible categorization for DC-DC boost converter kinds.

The output of power quality can be increased by using the interleaving technique. Interleaving techniques is one of the advisable solutions to reduce the ripple voltage and current for high power applications due to its harmonious circuit in design by paralleling two or more identical converters [5]. These advantages cause the proposed converter to be a good candidate for PV system applications. These benefits of interleaving technique encourage researchers to study and analyses under interleaved boost converter title

[7, 9, 10, 11].

This paper investigates the effectiveness offered by the interleaved boost converter. A comparison and performance analysis of both the interleaved boost converter and the conventional boost converter is presented. The validation was introduced through the steady-state analysis of traditional and interleaved boost DC-DC converter with different operating modes. Designs of the simulation were obtained using MATLAB/SIMULINK. The properties of the quality are compared with theoretical results.

2. DC-DC boost converter (step-up)

A boost converter is a converter with a voltage output in excess of its voltage input [12]. The traditional DC-DC boost converter circuit diagram is seen in Figure 2. It is a switching converter that operates by periodically ON-OFF state. Boost converter involves an input voltage V_{in} inductor L , controlled semiconductor switch (S) like MOSFET, IGBT and BJT, diode (D), capacitor (C_{out}), load resistance (R_{load}).

Continuous current mode (CCM) or discontinuous current mode (DCM) can be used by the boost converter. These modes can also be calculated by the current inductor value and can be calibrated by duty ratio. This paper investigates the continuous current mode (CCM).

When the switch S at ON state Figure 3, Diode D is reverse biased. The voltage of the inductor is much the same as that of input. The current rises and the energy stored in the inductor.

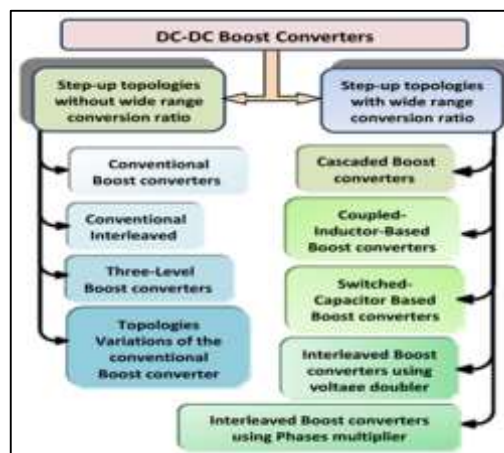

Figure 1: Proposed Category of non-isolated DC-DC boost converters

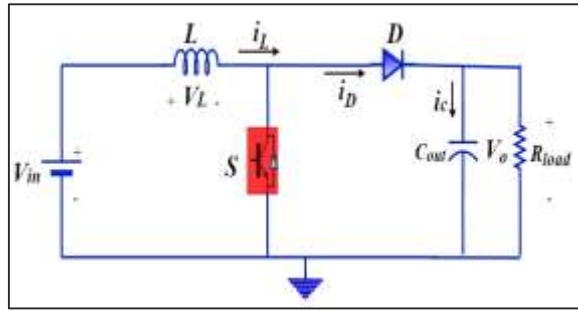

Figure 2: Circuit diagram of a conventional DC-DC boost converter

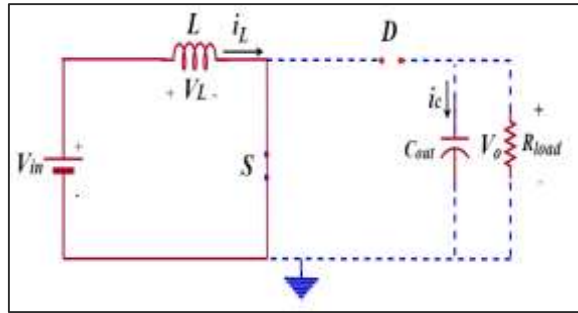

Figure 3: Traditional DC-DC boost converter in ON State (switch closed)

$$V_L = V_{in} \quad (1)$$

$$L \frac{di_L}{dt} = V_{in} \quad (2)$$

$di_L = \Delta i_L$; $dt = \delta T$ when the switch is close.

$$(\Delta i_L)_{closed} = \frac{V_{in} \delta T}{L} \quad (3)$$

Where δ is duty cycle ($\frac{t_{on}}{T}$), V_L and i_L are the inductor voltage and current respectively. T is really the one-cycle period, V_{in} is the input voltage.

When the switch S is in OFF states the diode D has become forward biased, Figure 4. The current flows in the direction to the load from the inductor and input source to receive energy stored. The current of the inductor reduces and the energy stored is released. This will cause the voltage of the output to surpass the voltage of the input.

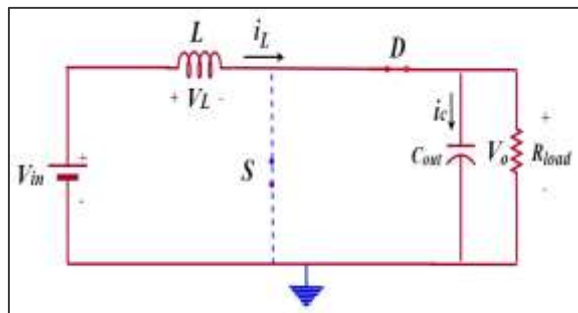

Figure 4: Traditional DC-DC boost converter in OFF State (switch opened)

$$V_L = V_{in} - V_o \quad (4)$$

$$L \frac{di_L}{dt} = V_{in} - V_o \quad (5)$$

$$(\Delta i_L)_{open} = \frac{(V_{in} - V_o)(1 - \delta)T}{L} \quad (6)$$

At Steady-state operation:

$$V_o = \frac{V_{in}}{1 - \delta} \quad (7)$$

Where:

V_o : Output voltage (V).

We can deduce in the above equation that while the switch S is in OFF state the output voltage is greater than the input voltage. For the desire to be more accurate in the estimation of output:

Input power = Output power

$$V_{in} I_{in} = \frac{V_o^2}{R} \quad (8)$$

Where R is the load resistance. By solving the average current of the inductor and making different adjustments, I_L can be expressed as:

$$I_L = \frac{V_{in}}{(1 - \delta)^2 R} \quad (9)$$

The average value and the current swing are used to determine the maximum and minimum inductor currents. The maximum current of the inductor can be written as:

$$I_{max} = I_L + \frac{\Delta i_L}{2} = \frac{V_{in}}{(1 - \delta)^2 R} + \frac{V_{in} \delta T}{2L} \quad (10)$$

The minimum current of the inductor may be written as:

$$I_{min} = I_L - \frac{\Delta i_L}{2} = \frac{V_{in}}{(1 - \delta)^2 R} - \frac{V_{in} \delta T}{2L} \quad (11)$$

In equation (11), the inductor current has been developed on the assumption that it is continuous, meaning that it is always positive. For I_{min} to be positive, this is a necessary condition. Therefore, (12) determines the boundary between continuous and discontinuous inductor current.

$$I_{min} = 0 = \frac{V_{in}}{(1 - \delta)^2 R} - \frac{V_{in} \delta T}{2L} \quad (12)$$

Thus, the boost converter's lowest possible combined effect of inductance and switching frequency is:

$$L_{min} = \frac{\delta (1 - \delta)^2 R}{2f} \quad (13)$$

Where:

f : Switching frequency (Hz).

I_{in} : Input current (A).

I_L : Inductor current (A).

L_{min} : Minimum of inductor (H).

In the boost converter, the inductor value is greater than L_{min} which is designed for continuous-current operation of a design spectacle. It is beneficial to describe L in terms of a desired Δi_L .

$$L = \frac{V_{in} \delta T}{\Delta i_L} = \frac{V_{in} \delta}{\Delta i_L f} \quad (14)$$

It is possible to write the ripple factor (r) and the lowest possible capacitor value for continuous current mode as:

$$|\Delta Q| = \left(\frac{V_o}{R}\right) \delta T = C \Delta V_o \quad (15)$$

$$r = \frac{\Delta V_o}{V_o} = \frac{\delta}{RC f} \quad (16)$$

$$C_{min} = \frac{\delta}{R \left(\frac{\Delta V_o}{V_o}\right) f} \quad (17)$$

Where:

- ΔV_o : Change of output voltage (V).
- ΔQ : Change in capacitor charge (C).
- r : Ripple factor (%).
- C_{min} : Minimum of capacitor (F).

3. Interleaved DC-DC boost converter

The interleaved boost converter means parallel connection of converters, by parallel connection the current divided. So, the I^2R losses minimized and current stress decreased. The current ripple at the output side will be reduced, and this shall reflect the input current also. The rating of the converter increase and the overall efficiency also increases due to the above reasons.

Interleaving technique is a various switching interconnection that improves synchronizing of the effective pulse frequency. The energy can be rescued and enhances power conversion without affecting conversion efficiency by an interleaving technique [1]. The interleaved DC-DC boost converter circuit graph is seen in Figure 5.

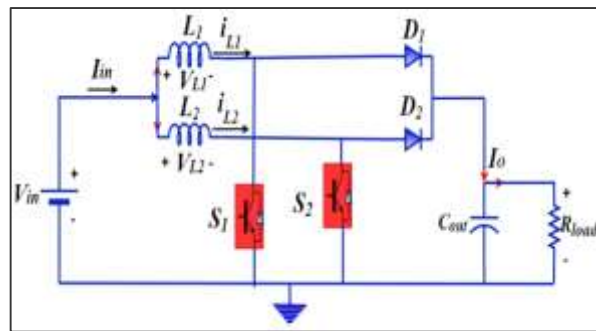

Figure 5: interleaved DC-DC boost converter

The interleaved boost converter comprises two parallel switches S_1, S_2 ; inductors L_1, L_2 , diodes D_1, D_2 Capacitor C and load resistor R with a trustworthy source of input (V_{in}). Phase-shifted switching function controls the switches. The boost converter interleaved can operate in four modes. Only continual current mode (CCM) is analyzed in this paper in order to simplify the calculation [13]. The two inductance values are considered similar ($L_1 = L_2 = L$) and similar duty cycles ($D_1 = D_2 = D$) with time delay by $\frac{T}{2}$.

Mode I: switch S_1 and S_2 are closed, D_1 and D_2 are turned off. The interleaved boost converter (IBC) circuit schematic in mode I can be seen in Figure 6. Diodes in this mode D_1 and D_2 are reverse biased. The input supply energy to the inductor L_1 , and L_2 resulting in rise of the inductor current i_{L1} and i_{L2} .

$$V_{L1} = V_{in} \quad (18)$$

$$V_{L2} = V_{in} \quad (19)$$

Where:

$$V_{L1} = L_1 \frac{di_{L1}}{dt} \text{ and } V_{L2} = L_2 \frac{di_{L2}}{dt}$$

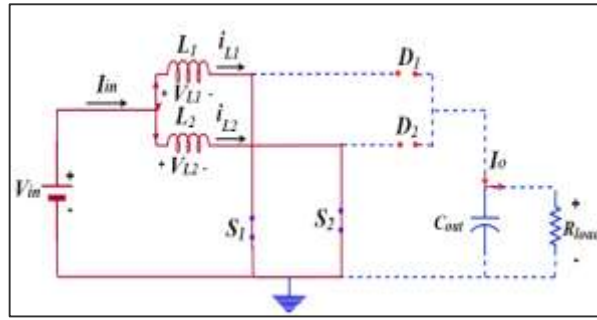

Figure 6: (Mode I of interleaved DC-DC boost converter)

Mode II: The switch S_1 closed, and S_2 opened, hence, D_1 turned OFF and D_2 turned ON. Figure 7 displays the interleaved boost converter circuit graph in mode II. Diode D_1 is backward biased in this mode while diode D_2 is forward biased. The input provides energy to the L_1 inductor, this leads to an increase in the inductor current i_{L1} .

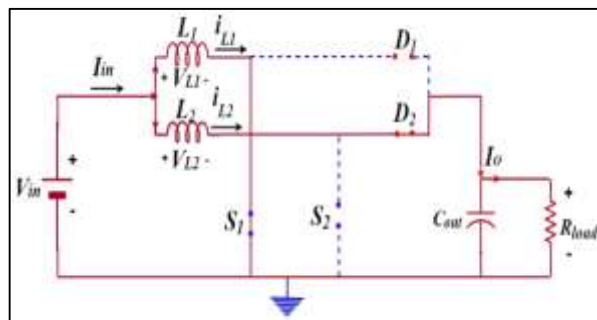

Figure 7: Mode II of interleaved DC-DC boost converter

Almost at the same time, the inductor L_2 provides the load with energy this leads to a lowering in the current i_{L2} of the inductor.

$$V_{L1} = V_{in} \quad (20)$$

$$V_{L2} = V_{in} - V_o \quad (21)$$

Mode III: The S_1 switch is opened, the S_2 switch is closed, then, D_1 turns ON and the D_2 turns OFF. Figure 8 indicates the interleaved DC-DC boost converter circuit diagram in mode III. Diode D_1 is forward biased in this mode while diode D_2 is backward biased. Inductor L_1 discharges and supplies the load with energy going to result in the current downturn i_{L1} inductor. Almost at the same time, The input is an energy supply to the Inductor L_2 leading to an increase in current of the inductor i_{L1} .

$$V_{L1} = V_{in} - V_o \quad (22)$$

$$V_{L2} = V_{in} \quad (23)$$

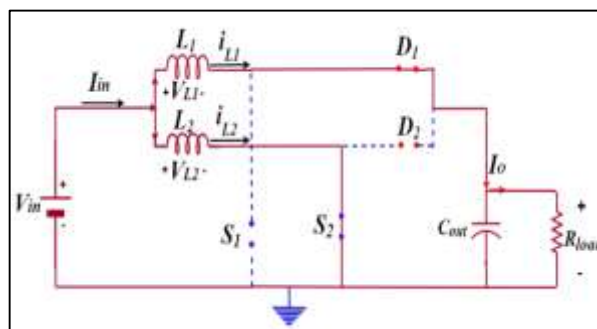

Figure 8: Mode III of (interleaved boost converter)

Mode IV: switches S_1 and S_2 are opened, D_1 and D_2 are turned ON. Figure 9 demonstrates the interleaved boost converter circuit schematic in mode IV.

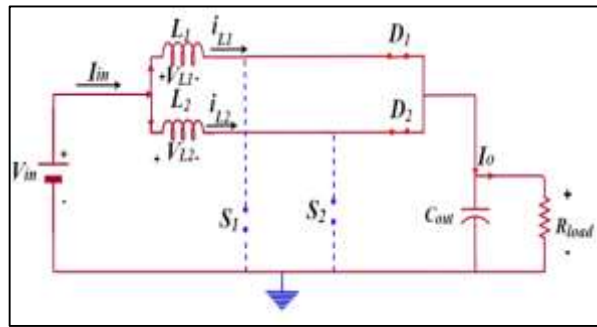

Figure 9: Mode IV of interleaved DC-DC boost converter

The diodes D_1, D_2 are biased forward in this mode IV. This causes both L_1, L_2 inductors to discharge and supply the load with energy this leads to a lowering in the current i_{L1} and i_{L2} inductor. The rate will change i_{L1} and i_{L2} can be written as:

$$V_L = V_{in} - V_o \quad (24)$$

$$\frac{di_{L1}}{dt} = \frac{di_{L2}}{dt} = \frac{V_{in} - V_o}{L} \quad (25)$$

For Steady-state operation

$$V_o = \frac{V_{in}}{(1 - \delta)} \quad (26)$$

The minimum inductor values L_1 and L_2 for continuous conduction (CCM) converter operation are specified by:

$$L_{1min} = L_{2min} = \frac{V_{in}\delta T}{2\Delta i_L} \quad (27)$$

Where:

L_{1min} is the minimum inductance value of L_1 . L_{2min} is the minimum inductance value of L_2 .

The capacitor C is given by:

$$C_{min} = \frac{\delta}{R\left(\frac{\Delta V_o}{V_o}\right)f_s} \quad (28)$$

4. Simulation

The Designs of the simulation are developed with MATLAB/SIMULINK platform. The main waveforms are shown in this section. The input DC voltages vary from 1V to 9V with a fixed duty cycle and measurement of output voltages. The converters' results waveforms were scoped within the same time scaling period for the observation, comparison and illustrated issues. The results are depicted with step up the voltage from 9V to 29.25V. Specification of converter parameters are $R=12\Omega$, $L_1=L_2=3mH$ and $C=10mF$ used for both converters. All switching elements are set at 20kHz switching frequency.

1. Traditional DC-DC boost converter

Figure 10 demonstrates the Simulink boost converter.

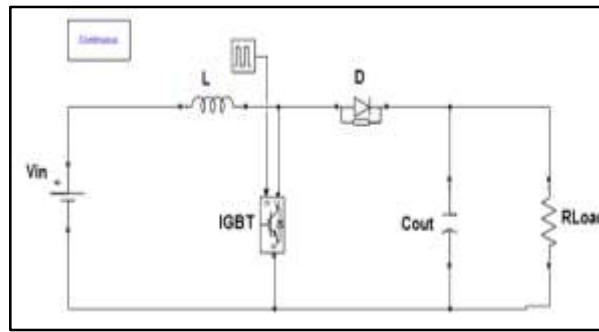

Figure 10: Simulation of conventional boost converter

Switching pulses with the simulation results of the boost converter are demonstrated in Figures 11,12,13,14,15 and 16.

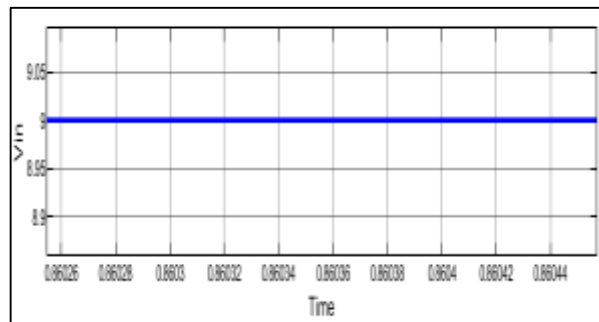

Figure 11: Input Voltage of conventional boost converter

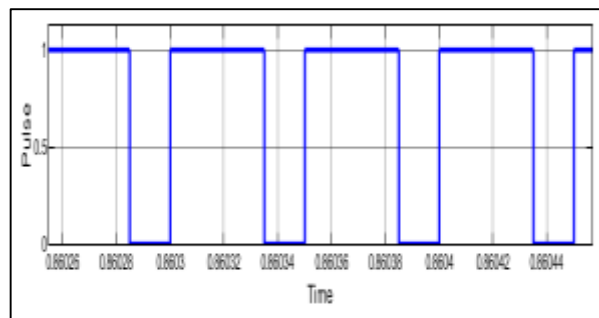

Figure 12: Switching pulse of conventional boost converter

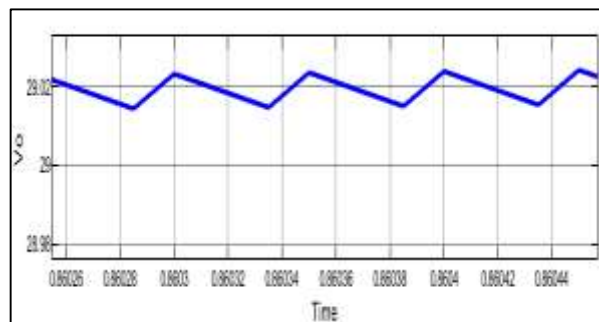

Figure 13: Output voltage of the conventional boost converter

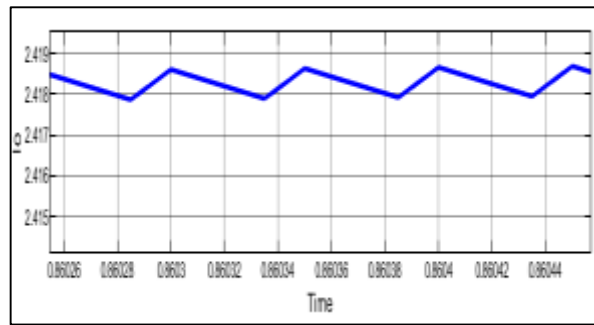

Figure 14: Output current of the conventional boost converter

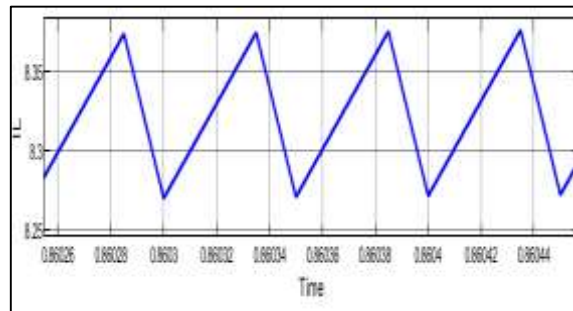

Figure 15: Inductor current of the conventional boost converter

Figures 13, 14 are displaying the ripples in current and output voltage. It is possible to observe that the output voltage and current ripples period are related to the switching frequency Figure 12. While the ripple limits are depending on the duty ratio and inductor value.

The inductor current (input current) waveform is depicted in Figure 15. It is clear that the inductor current is rise at instants when the switch is turned ON, while the output current is decay at the same instant, and vice versa.

Table 1 explains the comparison of conventional DC-DC boost converter theoretical and simulated voltages. The difference is very small, and it is clear that the converter’s voltage gain is about 3.33.

Table 1: Rapprochement of traditional boost converter theoretical and simulated voltage

Input voltage (V)	Theoretical output voltage (V)	Simulated output voltage (V)
1	3.333	2.64
2	6.666	6.16
3	10.000	9.8
4	13.333	13.8
5	16.666	16.78
6	20.000	20.1
7	23.333	23.45
8	26.666	26.4
9	30.000	29.25

Figure 16 show the varied I/P voltage from 1V to 9V with O/P voltage in theoretical and simulated are gradually symmetrical.

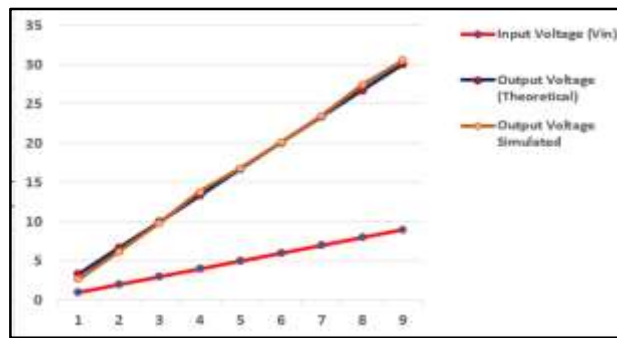

Figure 16: Rapprchement of output voltage simulated and theoretical voltage of traditional boost converter

II. Interleaved boost converter (IBC)

The interleaved boost converter circuit's scheme is shown in Figure 17. The switching elements are controlled (ON/OFF) by two channels to supply pulse with time delay $\frac{1}{2} T$ between two pulses, Figure 18. The duty ratios of the two channels are identical. The test interleaved boost converter performance comparing with a traditional boost converter, the results scoped within the identical period. The input DC voltages with the constant duty cycle vary from 1V to 9V, Figure 19. Parameters for specifications are the same as traditional boost converters.

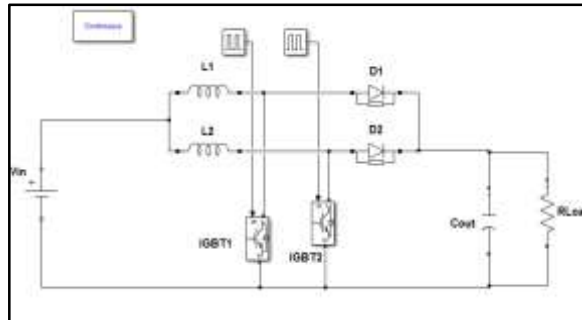

Figure 17: Simulation model of Interleaved boost converter

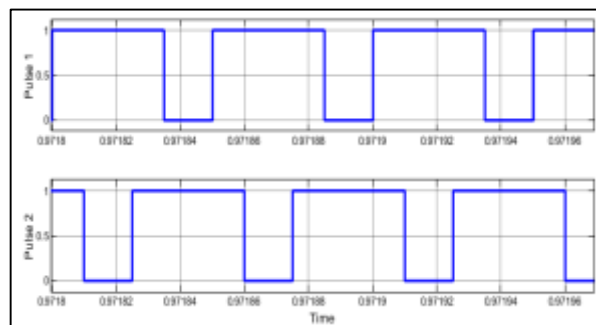

Figure 18: PWM of Interleaved boost converter

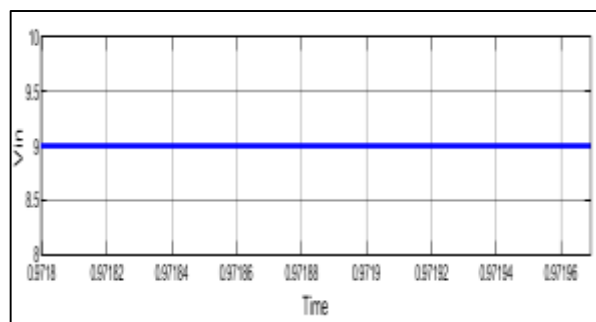

Figure 19: Input voltage of Interleaved boost converter

Figure 20 displays the inductors currents (i_{L1} and i_{L2}). Each inductor current is reflected in its switching pulses channel in Figure 18. Since the two channels supply pulse with time delay, $\frac{1}{2} T$, the input and output current ripple frequency is doubled and peak to peak ripple limit are reduced Figures 21 and 22. This is referring to one of the advantages of the interleaved boost converter. The current at the output side is incorporate at output voltage, Figure 23 shows the output voltage with ripple. The voltage output is boosted from 9V to 30.15V. The capacitor is employed to smoothing the voltage at the load side.

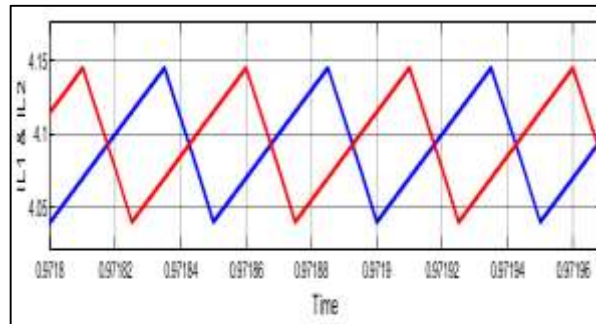

Figure 20: Inductors current for L_1 & L_2 of Interleaved boost converter

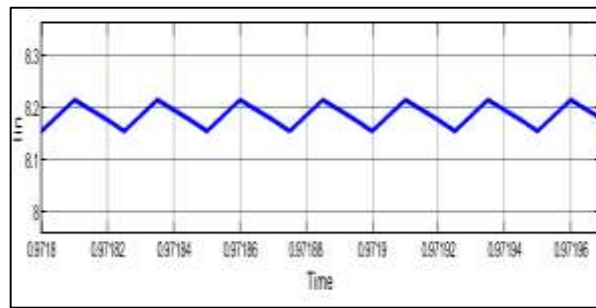

Figure 21: Input Current of Interleaved boost converter

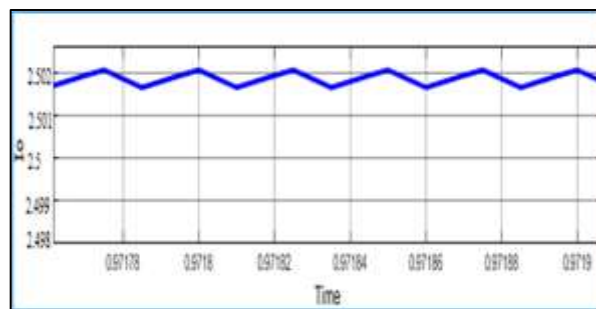

Figure 22: Output Current of Interleaved boost converter

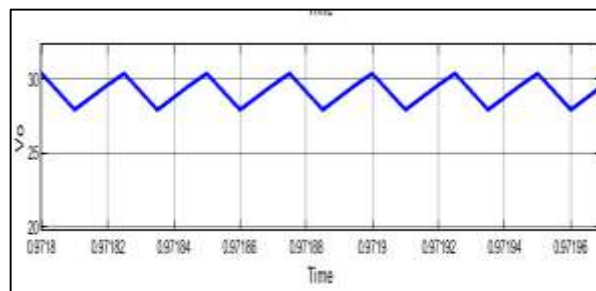

Figure 23: Output Voltage of Interleaved boost converter

With Interleaving technicality, every switching element are managing a percentage of the maximum total power depending on the number of parallel paths. So, the maximum stress of the device is decreasing. The resulting ripple is decreasing in the interleaved case. The input voltage of the boost

converter is contrasted to the mathematical and designed to simulate voltage as shown in table 2. The voltage achievement of the interleaved boost converter is about 3.335. For more visualize Figure 24 summarizes the theoretical and simulated output voltages with the varied input voltage.

Table 2: Rapprochement between interleaved DC-DC boost converter mathematical and simulated voltage

Input voltage (V)	Theoretical output voltage (V)	Simulated output voltage (V)
1	3.333	2.9
2	6.666	6.8
3	10.000	10.3
4	13.333	13.65
5	16.666	16.77
6	20.000	20.13
7	23.333	23.61
8	26.666	26.79
9	30.000	30.15

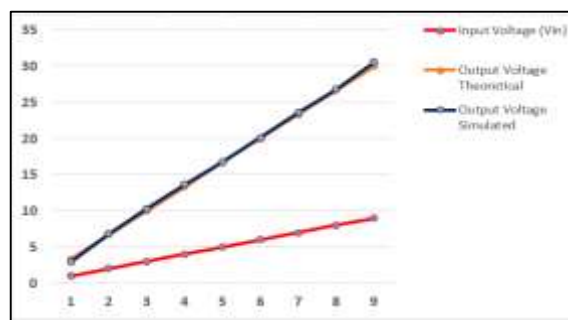

Figure 24: Comparison of V_o simulated vs theoretical voltage of Interleaved DC-DC boost converter

Table 3 is introducing a comparison between the two converters. The interleaved boost converter improves the efficiency, also reduce the voltage and current ripples at the I/P and the O/P side. Figure 25 shows the relation between the ripple of input current with a duty cycle for the boost converter and IBC.

Table 3: Comparison between Boost Converter and Interleaved Boost Converter

DC-DC Converter	Boost Converter	Interleaved Boost Converter (IBC)
Output Voltage (V_o)	29.25	30.15
Output Voltage ripple (%)	0.46	0.28
Output Current ripple (%)	0.19	0.01
Input Current ripple (%)	0.15	0.05
Efficiency (%)	95.4	97.77

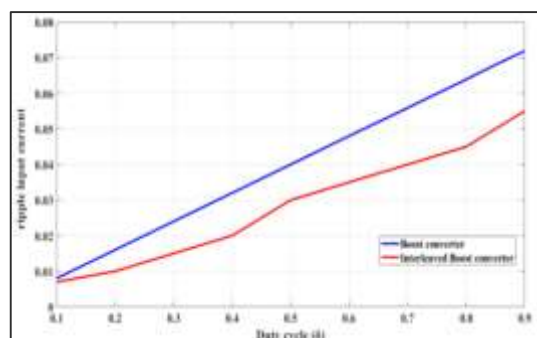

Figure 25: Ripple input current vs duty cycle.

5. Conclusion

This paper has researched the differences between the classical boost converter and the interleaved boost converter. Conventional boost DC-DC converter efficiency specifications and interleaved boost DC-DC converter were analysed mathematically within various modes of operation. Then, the two converters examined through simulation using MATLAB/SIMULINK.

The approach employs for comparison between the power quality productions by the two converters. It can decrease the output current and voltage ripple effects by using interleaving techniques, thus decreasing switching losses and increasing efficiency.

In practice, the fixed gain from the traditional boost converter is confined because of the high voltage output requires a high duty ratio, which means that the switch stays ON for long periods of time. If a current is high in the diode, this will lead to the reverse recovery phenomenon.

Through the mathematical analysis and simulation results comparison between the traditional boost converter and IBC, the IBC are reduced the current and voltage ripple as well as reduce the voltage stress across the switching. as a result, it improved the efficiency compared with a traditional boost converter.

Finally, the analysis and simulation evaluation results are encouraging to implementing IBC practically as future work.

Abbreviations and Acronyms

- IBC: Interleaved Boost Converter.
- PV: Photovoltaic.
- MPPT: Maximum Power Point Tracking.
- CCM: Continuous Current Mode.
- DCM: Discontinuous Current Mode.

References

- [1] S. H. Elkelani Babaa, "High efficient interleaved boost converter with novel switch adaptive control in photovoltaic application," Ph.D. Thesis, Electronic and Computer Eng. Dept., Univ. of Newcastle, Newcastle, England, 2013.
- [2] F. S. Garcia, J. A. Pomilio, and G. Spiazzi, "Modeling and control design of the interleaved double dual boost converter," *IEEE Transactions on Industrial Electronics*, Vol. 60, No. 8, pp. 1292–1300, 2013.
- [3] K. C. Tseng, C. C. Huang, and W. Y. Shih, "A high step-up converter with a voltage multiplier module for a photovoltaic system," *IEEE Transactions on Power Electronics*, Vol. 28, No. 6, pp. 3047–3057, 2013.
- [4] Y. Jang and M. M. Jovanovic, "Interleaved boost converter with intrinsic voltage-doubler characteristic for universal-line PFC front end," *IEEE Transactions on Power Electronics*, Vol. 22, No.4, pp.1394-1401, 2007.
- [5] C. Liu, A. Johnson and J.S. Lai, "A novel three-phase high-power soft-switched DC-DC converter for low-voltage fuel cell applications," *IEEE Transactions on Industry Applications*, Vol. 41, No. 6, pp. 1691-1697, 2005.
- [6] J. S. Anu Rahavi, T. Kanagapriya and Dr. R. Seyezhai, "Design and analysis of interleaved boost converter for renewable energy source," *International Conference on Computing, Electronics and Electrical Technologies, ICCEET*, India, 2012.
- [7] M. Z. Hossain, N. A. Rahim and J. A. Selvaraja, "Recent progress and development on power DC-DC converter topology, control, design and applications: A review," *Renewable and Sustainable Energy Reviews*, Vol. 81, No. 1, pp. 205-230, January 2018.
- [8] M.H. Rashid, "Power electronics, circuits, devices and applications," Prentice Hall, 3rd edition, Amsterdam, 2011.
- [9] R.S. Mishra, N. Verma and S.D. Shukla, "Implementation of solar based PWM fed two phase interleaved boost converter," *International Conference on Communication, Control and Intelligent System, CCIS*, Mathura, India, pp. 470-476, 2015.
- [10] D.J.S. Newlin, R. Ramalakshmi and Mr.S. Rajasekaran, "A performance comparison of interleaved boost converter and conventional boost converter for renewable energy application," *Proceedings of 2013 international conference on green high performance computing, ICGHPC*, Nagercoil, India, pp. 1-6, 2013.
- [11] S.S. Mohammed and D. Devaraj, "Simulation of incremental conductance MPPT based two phase interleaved boost converter using MATLAB/Simulink," *IEEE international conference on electrical, computer and communication technologies, ICECCT*, Coimbatore, India, pp. 1-6, 2015.

- [12] V. Michal, D. Cottin, and P. Arno, "Boost DC-DC converter nonlinearity and RHP-zero: survey of the control-to-output transfer function linearization methods," Invited paper, in proc. of 21st IEEE int. conference Applied Electronics, ICAE21, Pilsen, Czech Republic, pp.1803-7232, 2016.
- [13] J. Chen, D. Maksimovic and R.W. Erickson "Analysis and design of a low-stress buck-boost converter in universal-input PFC applications," IEEE Transactions on Power Electronics, Vol. 21, No. 2, pp.320-329, 2006.