

ISSN: 1813-162X (Print) ; 2312-7589 (Online)

Tikrit Journal of Engineering Sciences

available online at: <http://www.tj-es.com>
TJES
 Tikrit Journal of
 Engineering Sciences

Husain Khalaf Jarallah

Nidaa Qassim Jassim *

 Department of Civil Engineering
 Faculty of Engineering
 Mustansiriyah University
 Baghdad
 Iraq

Ductility Improvement of R.C Beams with Large Web opening by using Reactive Powder Concrete Layers

ABSTRACT

In this investigation the effect of large web opening on the behavior of beams made by normal concrete (NC) and reactive powder concrete (RPC) have been studied. The experimental work consists of casting and testing in flexure 12 rectangular simply supported reinforced concrete beams. The main parameters of this test are opening locations and normal concrete and RPC location with is the section. The ultimate loads, cracking loads, load-deflection behavior, skew of the openings (deflection at the two opposite corners of openings) and ductility were discussed. These results showed that increase ultimate loads (P_u) and stiffness by increase RPC layers. The using RPC layers increase ultimate load about (1-30) %. Using RPC in compression fiber is found to be more effective than using RPC in tension fiber. The cracking load of hybrid beam with one layer of RPC in compression fiber (having one opening) higher than NC beams by 48.5%. The ultimate strength was decreases with increases opening about (4-21)%, thus indicating that the stiffness decreases accordingly. Hybrid beams with RPC in tension fiber failed with less crack than those for hybrid beams with RPC in compression fiber at the same number of openings. The skew at opening of flexural zone show greater values than the skew at opening in shear zone for each beam until failure. The increase in the number of openings leads to increase in the ductility because it reduces the strength of beams.

Keywords:

 Reactive powder composite
 openings
 layers
 deflection
 skew of openings
 ductility

ARTICLE INFO

Article history:

 Received 20 January 2018
 Accepted 13 June 2018
 Available online 01 September 2018

© 2018 TJES, College of Engineering, Tikrit University

DOI: <http://dx.doi.org/10.25130/tjes.25.3.06>

تأثير الفتحات العريضة على العتبات الخرسانية المسلحة والمدعمة بخرسانة المساحيق المركبة

الخلاصة

ان في هذه التحريات تم دراسة تأثير الفتحات لعريضة على سلوك العتبات الخرسانية المسلحة والمصنوعة من الخرسانة الاعتيادية والخرسانة الهجينة (خرسانة اعتيادية وخرسانة المساحيق المركبة) تضمن العمل صب وفحص 12 عتبة خرسانية مسلحة مستطيلة ذات الاسناد البسيط، ان المتغيرات الرئيسية في هذا البحث هو تغير موقع الفتحات وكذلك موقع طبقات خرسانة المساحيق الفعالة في المقطع. تم مناقشة الاحمال القصوى، احمال التشقق، الهطول، وانحراف الفتحات (الهطول في الحافات المتقابلة للفتحة) والمطيلية. اظهرت النتائج المختبرية بصورة عامة ان الاحمال القصوى والصلابة للعتبات تزداد مع زيادة طبقات خرسانة المساحيق المركبة. استخدام طبقات خرسانة المساحيق المركبة يزيد من الحمل الأقصى بمقدار (1-30)%. وان استخدام خرسانة المساحيق المركبة في منطقة الانضغاط يكون اكثر فعالية من استخدامها في منطقة الشد مثلا الحمل الاقصى للعتبة الهجينة بطبقة واحدة من خرسانة المساحيق المركبة في منطقة الانضغاط مع فتحة واحدة تكون اعلى من العتبة الخرسانية ذات الخرسانة الاعتيادية بمقدار 48.5%. المقاومة القصوى تقل بزيادة الفتحات بمقدار (4-21)% والعتبات الهجينة ذات خرسانة المساحيق المركبة في منطقة الشد والتي تحوي نفس العدد من الفتحات تفشل بتشققات اقل من العتبات الهجينة ذات خرسانة لمساحيق المركبة في منطقة الانضغاط، انحراف الفتحات لكل العتبات لنهاية الفشل يكون في منطقة الانحناء اعلى من منطقة القص. الزيادة في عدد الفتحات تؤدي الى زيادة في المطيلية بسبب نقصان في مقاومة العتبات.

1. INTRODUCTION

In modern building construction, transverse openings in reinforced concrete beams are often provided for the

passage of utility ducts and pipes. These ducts are necessary in order to accommodate essential services such as water supply, electricity, telephone, and computer network. These ducts and pipes are usually placed underneath the soffit of the beam and for aesthetic reasons,

* Corresponding author: E-mail : nidaaqj@gmail.com

are covered by a suspended ceiling, thus creating a dead space. In each floor, the height of this dead space adds to the overall height of the building depending on the number and depth of ducts. Therefore, the web openings enable the designer to reduce the height of the structure, especially with regard to tall building construction, thus leading to a highly economical design. The openings can be of different shapes and sizes as circular, square or rectangular [1].

Mansur et al. [2], examined the strut-and-tie model for the analysis of a reinforced concrete beam that contains geometric discontinuities in the form of a transverse circular opening in the web. The presence of an opening in the web of a reinforced concrete beam leads to many problems in the beam behavior such as reduction in the beam stiffness, excessive cracking, excessive deflection and reduction in the beam strength [3,4].

Maaddawy and Ariss [5], conducted studies on RC beams with web openings strengthened in shear with externally bonded CFRP composite sheets. Javad and Morteza [6] investigated the effect of small circular openings on the shear, flexural and ultimate strength of beams made by normal and high strength concrete. Strengthening of rectangular openings at the shear zone was studied by The behavior and failure modes of RC beams with web openings strengthened with externally bonded CFRP sheets has been investigated by Chin et al. [7].

No research was conducted for RC beams having large openings fortified with RPC. Therefore the aim of this research is to investigate the amount of the effect of the

presence of large opening in the web of reinforced concrete beams fortified with RPC layers and the evaluation of these effects which includes the effect on the ultimate strength, the type of failure, deflection, skew of openings, ductility. The main factors in this study are the number of web openings along the span and RPC layer locations. The results of ultimate strength, load-deflection, failure modes, deflection, skew of openings, ductility will be discussed.

2. EXPERIMENTAL PROGRAM

A total of twelve beams with different large web openings and RPC layer locations were investigated. The details of the shape and size of the beams were shown in Fig. 1. The details of these beams are shown in Fig. 2, all detailing specifications were as per recommendation of ACI 318M-14 [8] and NZS3101-2(2006) [9].

2.1. Materials used

In this study two types of concrete are used, type one: reactive powder concrete (RPC) this concrete contains (high content of cement+ fine aggregate, silica fume, superplasticizer with water and steel fiber) with mix proportion equal to 1:1:0.25, type two: Normal strength concrete (NC) "conventional concrete" this concrete contains (cement, fine aggregate, coarse aggregate and water) with mix proportion equal to 1:1.5:3. Two sizes of

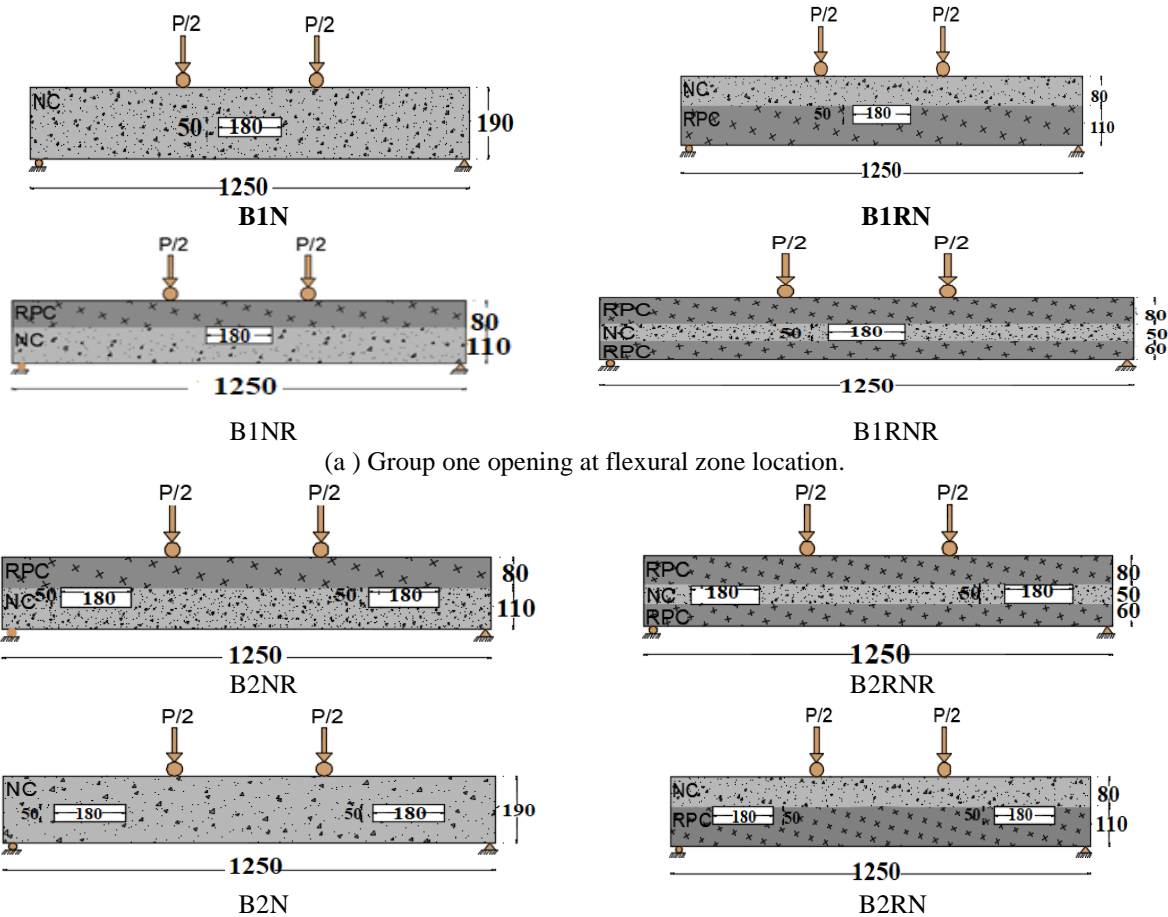
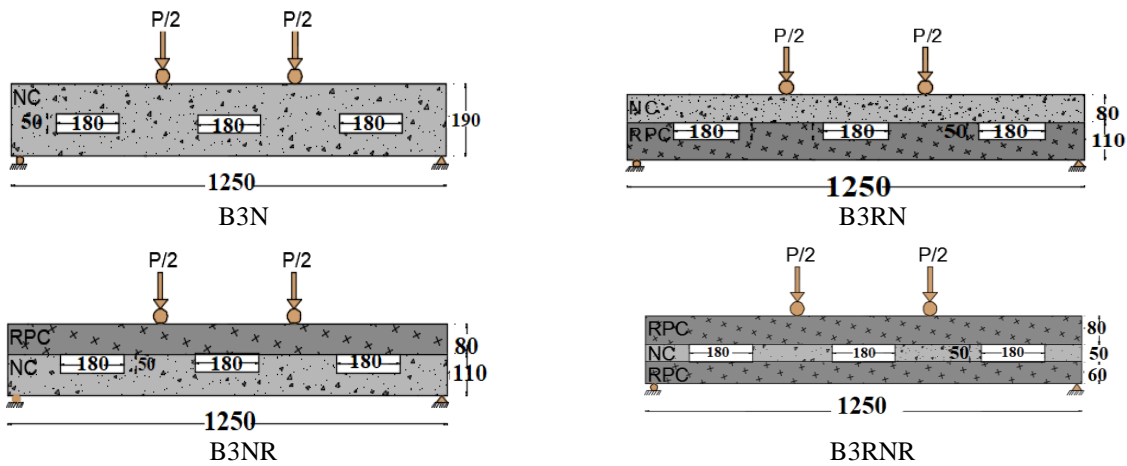

Fig. 1. Continuous.



(c) Group three opening at compound (Flexural+ Shear) zone location.

Fig. 1. Beams details (layers and openings).

Table 1

Properties of steel bars.

Bar diameter (mm)	Actual diameter (mm)	Yield stress (Mpa)	strain at yield stress ($\mu\epsilon$)	Ultimate stress (Mpa)	Ultimate strain ($\mu\epsilon$)	Modulus of elasticity (Gpa)
4	4.45	390	2000	464.7	2396.9	3433.6
8	8.08	470.8	2361	683.3	195	199

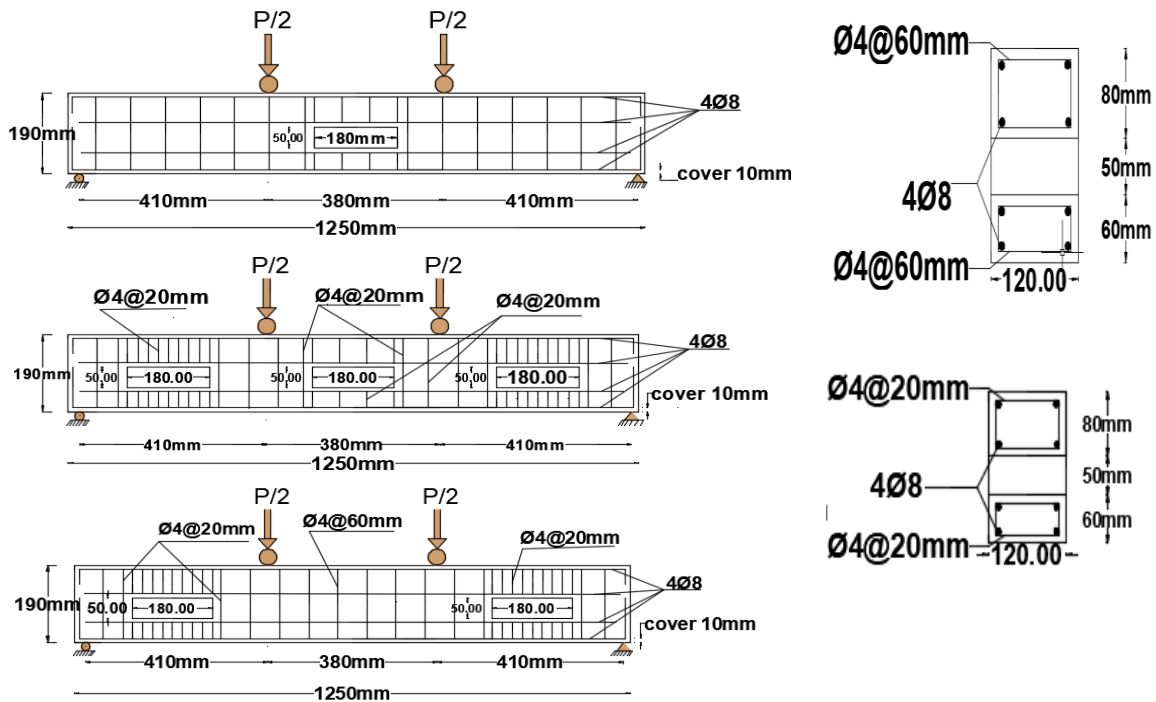

Fig. 2. The beams details.

steel reinforcing bars were used in the tested beams, deformed bars of size ($\varnothing 8$) mm were used as longitudinal reinforcement, and deformed steel bars of size ($\varnothing 4$) mm were used as closed stirrups. The results in Table 1 conform to the limitation of the Specification ASTM A615 [10].

2.2. Casting Procedure

Casting of NC beams was done by placing the specific concrete into molds continuously in a three layers with each layer being vibrated using a table vibrator to

obtain a more compacted concrete. For hybrid beams (two or three layers beams), bottom layer which may be NC or RPC was mixed and placed first, then top layer (RPC or NC) was mixed and placed above the first one, with each layer being vibrated using a table vibrator to obtain more compacted concrete. The time period between the placing of the two layers was about (55-60) minutes where the top to ensure good interaction between the two layers. This time it was obtained by conducting an initial sitting time experiment for RPC the test was performed according to

ASTM C191-13 [11] by Vicat Needle and the setting time was about (45-50) minutes for NC.

2.3. Test set-up and Instrumentation

The loading was applied through a hydraulic jack. Fig. 3 dial gauge was used to measure the vertical deflection (displacement) at mid-spans dial gauge A, quarter-span dial gauge B and skew of openings dial gauge C and D (measure the deflection of opening) at beam one and two openings only, used a metal pieces put at two locations the first are glued on top corner of opening by epoxy resin and the second are glued on opposite bottom corner of opening by epoxy resin. As shown Fig. 4. The use of devices with high accuracy is required to calculate the amount of strain in the steel was used. Locations of strain gauge were selected to give an impression about what is happening of strain and stress in steel reinforcement as shown Fig. 5. The load is increased gradually and in every 2.5 kN step for all the strain reading is taken by the data logger.

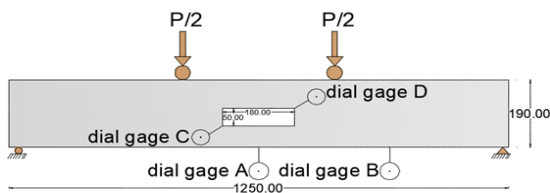

Fig. 3. Location of the dial gauge at beams.



Fig. 4. Metal pieces.

3. RESULTS AND DISCUSSIONS

3.1. Cracking Loads Results

The results of load at which the first visible crack was detected were listed in Tables 2 and 3. The results shown that the cracking load increases when ultimate load increases. The ratio of cracking load to ultimate load (P_{cr}/P_u) was generally between 18% and 30%. It ranges from 14 kN in beam B3N to 39 kN in beam B1RNR. This ratio increases with the RPC layer in tension or compression or together. This ratio reduction with increase number openings

3.1.1. Effect of Openings

The results of the effect of the number of openings on first crack load are listed in Table 2. The results shown that these parameters affect the cracking load and ultimate load in a similar way with increase openings beam stiffness will reduction and consequently reduction both the cracking load and ultimate load

Table 2

Effect of number of openings on first crack load.

No of openings	Beams	P _{cr} (kN)	Percentage of Reduction %
1	B1N	21.5	0
2	B2N	18.5	13.95
3	B3N	14	34.88
1	B1RN	26	0
2	B2RN	21	19.23
3	B3RN	17.5	52.38
1	B1NR	32	0
2	B2NR	27.5	14.06
3	B3NR	21	34.37
1	B1RNR	39	0
2	B2RNR	33	15.38
3	B3RNR	25	35.89

3.1.2. Effect of RPC Layers

The results of effect of RPC layers in on first crack load were listed in Table 3. These parameters affect the cracking load and ultimate load in a comparable way that because of attributed to the fact that found RPC layer will increase beam stiffness and consequently increases both the cracking load and ultimate load. For hybrid beams with RPC in compression values for cracking loads higher from tension are recorded due to the tension faces of these beams are always NC which has a lower flexural strength (and consequently lower cracking load) than that of RPC.

Table 3

Effect of RPC layers in on first crack load.

Opening location	Beams	P _{cr} (kN)	Percentage of increase %
Flexural	B1N	21.5	0
	B1RN	26	20.9
	B1NR	32	48.5
	B1RNR	39	81.3
Shear	B2N	18.5	0
	B2RN	21	13.5
	B2NR	27.5	48.6
Compound (Flexural+ Shear)	B2RNR	33	78.3
	B3N	14	0
	B3RN	17.5	25
	B3NR	21	50
	B3RNR	25	78.5

3.2. Ultimate Loads of the Tested Beams

The reduction in the ultimate failure loads results presented in the Table 4 it is clear that the presence of an openings not only reduced the ultimate load capacity of the beam but also changed the failure mode from a flexural

mode to a shear mode of failure. The results presented in the Table 5 generally show that ultimate loads (P_u) increase with the increase of RPC layer hybrid beams with RPC in compression show generally higher ultimate loads than those of hybrid beams with RPC in tension. All above results indicate that using RPC in compression and tension

is more effective than using RPC in compression only and tension only This behavior may be attributed to the combined contribution in increasing the beams stiffness which allows such beams to sustain higher loads before failure.

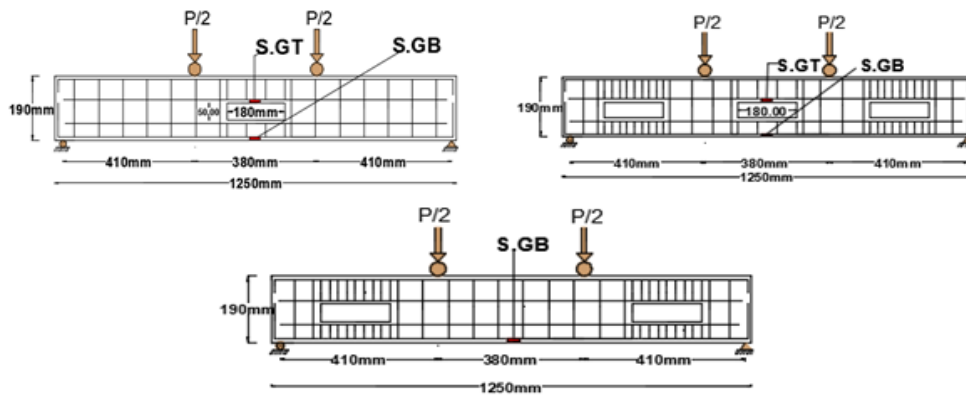

where S.GT-strain gage at Top, S.GB-strain gage at Bottom

Fig. 5. Strain gage location of reinforcement.

Table 4
Effect of number of opening on ultimate loads.

No of openings	Beams	P_u (kN)	Percentage of reduction (%)
1	B1N	92.50	0
2	B2N	85.00	8
3	B3N	77.50	16
1	B1RN	94.00	0
2	B2RN	88.00	6
3	B3RN	80.00	14
1	B1NR	117.50	0
2	B2NR	105.00	10
3	B3NR	92.50	21
1	B1RNR	129.00	0
2	B2RNR	125.00	3
3	B3RNR	101.50	21

Table 5
Effect of RPC layers on ultimate loads.

Open location	Beams	P_u (kN)	Percentage of increase (%)
Flexural zone	Group 1	B1N	92.5 0
		B1RN	94 1
		B1NR	117.5 27
		B1RNR	129 39
Shear zone	Group 2	B2N	85 0
		B2RN	88 3
		B2NR	105 23
		B2RNR	125 47
Compoud (Flexural+ Shear) zone	Group 3	B3N	77.5 0
		B3RN	80 3
		B3NR	92.5 19
		B3RNR	101.5 30

3.3. Failures Modes

The type of failure of tested beams with opening was characterized by the formation of cracks at the location as shown Fig. 5. Failure modes of tested beam are given Table 6.

Table 6
Modes of failures of the tested beams.

Beams	Failure modes of RC with openings
B1N	Flexure
B2N	Shear
B3N	beam-type shear failure
B1RN	Flexure +crush at Flexural
B2RN	Shear
B3RN	vierendeel truss action + beam-type shear failure + crush at shear
B1NR	Flexure + crush at Flexural
B2NR	Shear
B3NR	Tension-controlled flexural failure + beam-type shear failure
B1RNR	Flexure + crush at Flexural
B2RNR	Shear
B3RNR	vierendeel truss action + beam-type shear failure

3.4. Load-Deflection Curves

The results showed that the load-deflection of all beams at the first stage loading was similar. After that the deflections at mid-span show greater values than the deflections at mid opening in shear span for each beam until failure as shown in Figs. 7-14 shows load-mid-span deflection relationships at dial gage (A) and Figs. 15-21 shows load-mid opening deflection in shear span at dial gage (B), and Fig. 22 shows Load-Conner deflection at dial gage (c) and (d) for all tested beams.

3.4.1. Effect of Opening Locations

From this Figs. 7-10 it can be noticed when increase in the number of openings in the beams causes reduction both ultimate load and their stiffness so causes increase in their deflections The maximum mid-span deflection as shown in Table 7 while The maximum deflection in shear

span is the less than the maximum mid-span deflection as shown Figs. 15-18.

Table 7

Effect of number of opening in maximum mid-span deflection.

No of openings	Beams	Load (kN)	Maximum mid-span deflection (mm)
1	B1N	87.5	9
2	B2N	82.5	11
3	B3N	77.5	13
1	B1RN	87.5	5.4
2	B2RN	87.5	7
3	B3RN	77.5	9
1	B1NR	112.5	7.2
2	B2NR	100	9
3	B3NR	90	12
1	B1RNR	125	11
2	B2RNR	122.5	13
3	B3RNR	97.5	15.55

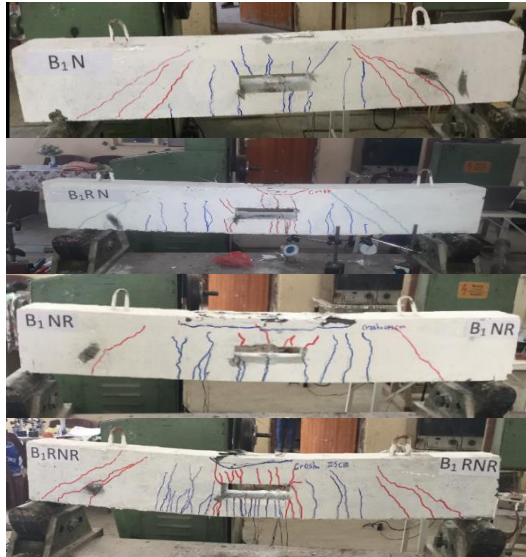

(a) Group one.

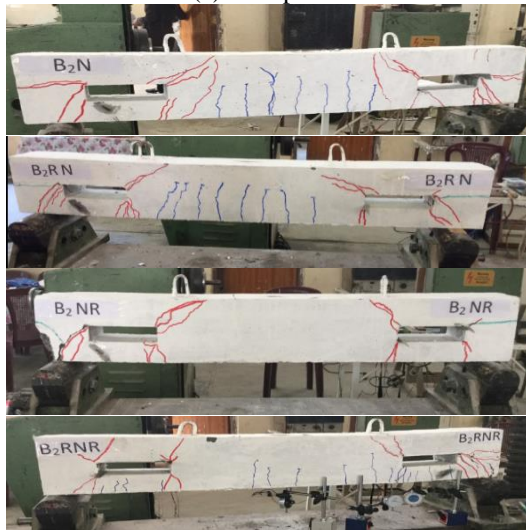

(b) Group two.



(c) Group three.

Fig. 6. Crack patterns at failure stage.

3.4.2. Effect of RPC Layers

From Table 8 noted the maximum mid-span deflections of hybrid beams with different RPC layers hybrid beams, the hybrid beams with one layer of RPC in compression exhibit larger deflections than those for hybrid beams with RPC in tension. This may be attributed to the higher flexural strength of these beams which allows them to withstand larger deflections before failure (higher energy absorption). From these Figs. 11-14, maximum mid-span deflections of hybrid beam with one layer of RPC in tension zone were lower than that of NC beams for all beams, while hybrid beams with RPC in tension and compression show higher maximum deflections than NC because of their high ductility. While the maximum deflection in shear span is the less than the maximum mid-span deflection as shown Figs. 19-21.

Table 8

Effect of RPC layers in maximum mid-span deflections.

Open location	Beams	Load (kN)	Maximum mid-span deflection (mm)
Flexural zone	Grope 1 B1N	87.5	9
	B1RN	87.5	5.4
	B1NR	112.5	7.2
	B1RNR	125.5	11
Shear zone	Grope 1 B2N	82.5	11
	B2RN	87.5	7
	B2NR	100	9
Compoud (Flexural + Shear) zone	Grope 1 B2RNR	122.5	13
	B3N	77.5	13
	B3RN	77.5	9
	B3NR	90	12
	B3RNR	97.5	12.5

3.5. Skew of the Openings

Fig. 20 it can be seen that the load versus deflection curves are similar for all beams at early stages of loading after that the skew at opening of flexural zone show greater

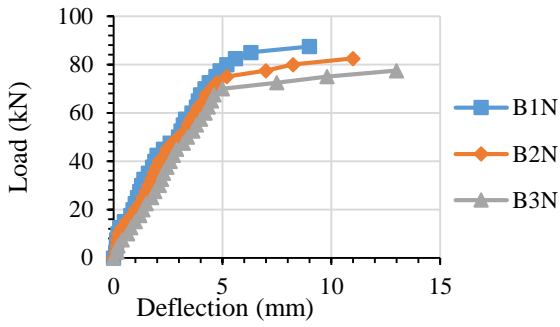

Fig. 7. Effect number of openings on load-deflection for NC at mid-span.

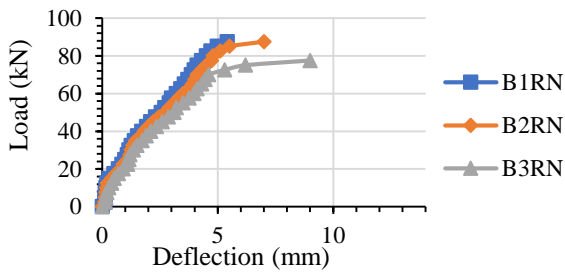

Fig. 8. Effect number of openings on load-deflection for RN at mid-span.

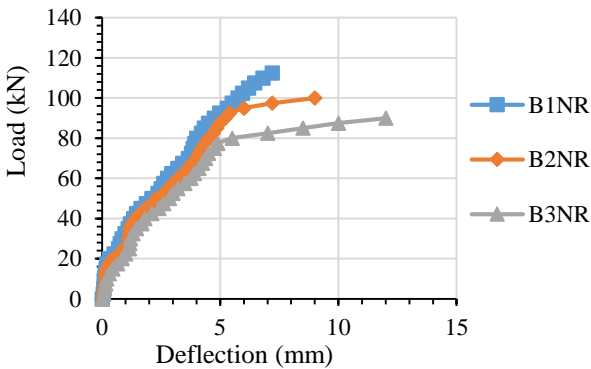

Fig. 9. Effect number of openings on load-deflection for NR at mid-span.

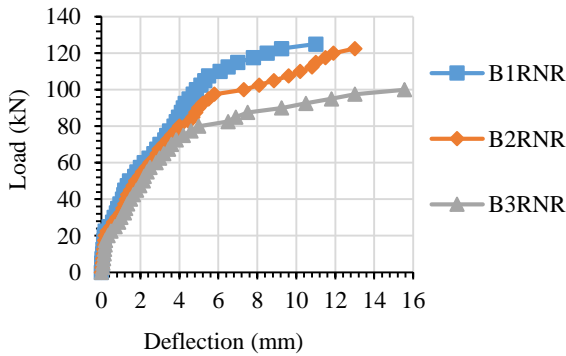

Fig. 10. Effect number of openings on load-deflection for RNR at mid-span.

values than the skew at opening in shear zone for each beam until failure. But the skew of the lower edge is more than the top edge for beams (B1N, B1RNR, B2N and B2RNR) as shown Fig. 22. Still further it can be observed

in beams for (B1RN, B1NR, B2R and B2NR) that the presence of the RPC at any corner reduces the skew because it is a material with higher resistance than the normal and thus gives higher stiffness (higher energy absorption).

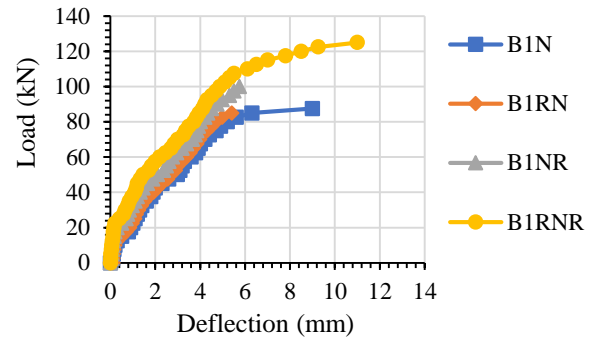

Fig. 11. Load-deflection curve for group one at mid-span.

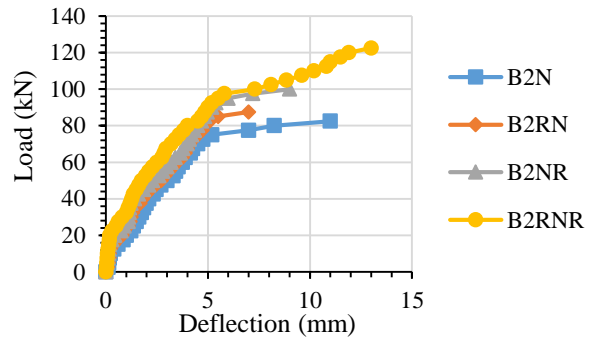

Fig. 12. Load-deflection curve for group three at mid-span.

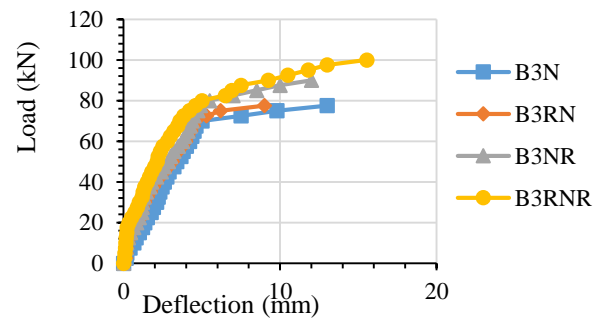

Fig. 13. Effect number of openings on load-deflection for RNR at mid-span.

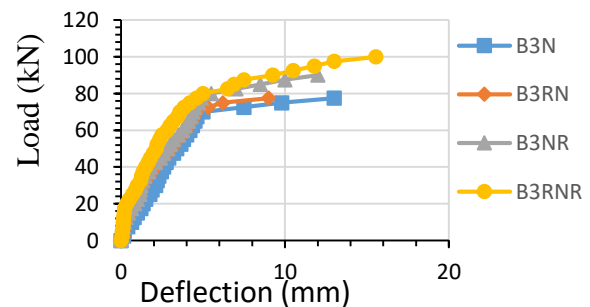

Fig. 14. Load-Deflection curve for group three at mid-span.

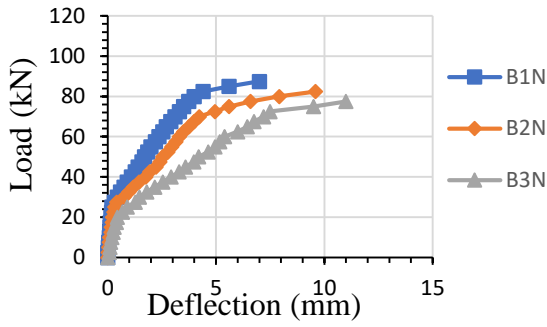

Fig. 15. Effect number of openings on Load-Deflection for NC at shear span.

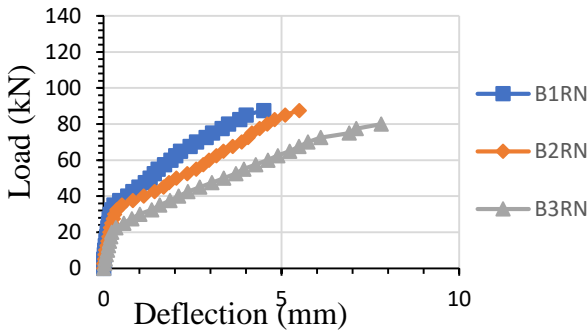

Fig. 16. Effect number of openings on load-deflection for RN at shear span.

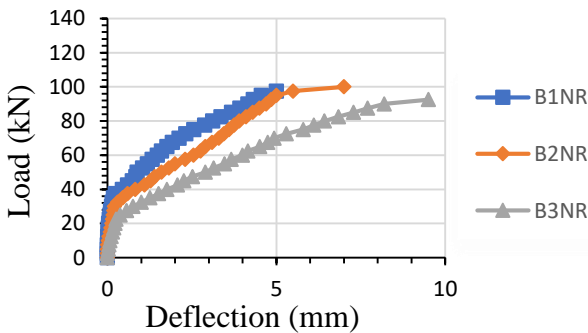

Fig. 17. Effect number of openings on load-deflection for NR at shear span.

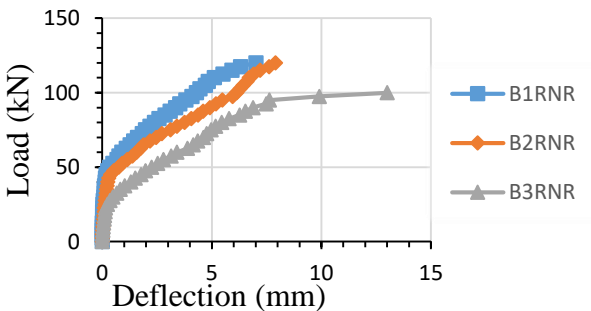

Fig. 18. Effect number of openings on load-deflection for RNR at shear span.

3.6. Ductility Demand

Ductility is defined as ratio of ultimate deformation to yield deformation [12,13]. Ductility displacement is related to both the structural configuration and the cross

section behavior. There are many ways in which the ductility can be measure as shown in Eq. (1).

$$\text{Member ductility } (\mu\Delta = \Delta u/\Delta y) \tag{1}$$

where Δu is the mid-span deflection at ultimate load, and Δy is mid-span deflection at yield steel [14] as shown Table 9.

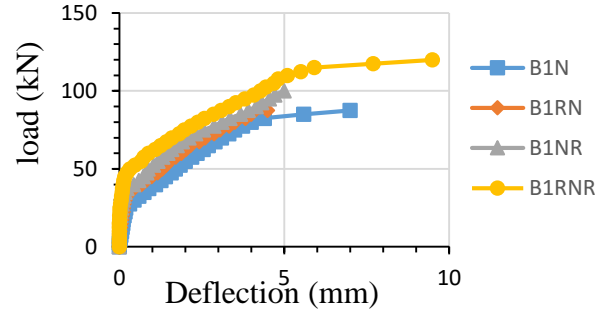

Fig. 19. Load-deflection curve for group one at shear span.

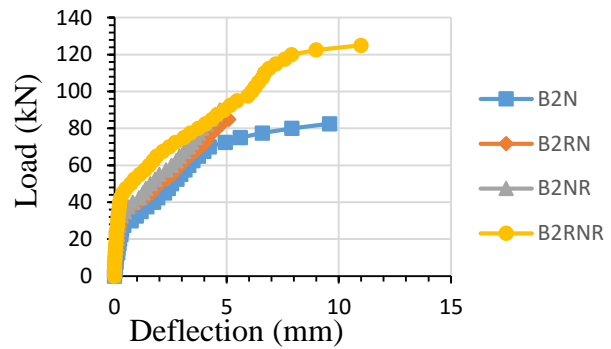

Fig. 20. Load-deflection curve for group two at shear span.

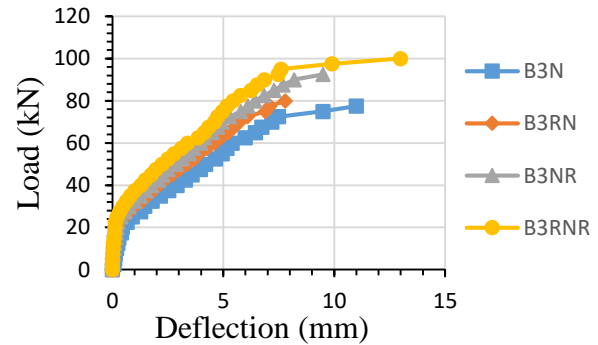

Fig. 21. Load-deflection curve for group three at shear span.

From the steel tensile strain curve obtained for beams under static load it can be noted that the maximum strain is occurred at the bottom chord for all beams and the first yield occurred at bottom chord for all beams. the ductility can be measure as in Eq. (2).

$$\text{Material ductility } \left(\mu_\epsilon = \frac{\epsilon u}{\epsilon y} \right) \tag{2}$$

where ϵ_u is the strain at ultimate for bottom chord in mid span, and ϵ_y is the strain at yield steel from test of reinforcement as shown Table 10. The increase in the number of openings leads to increase in the ductility

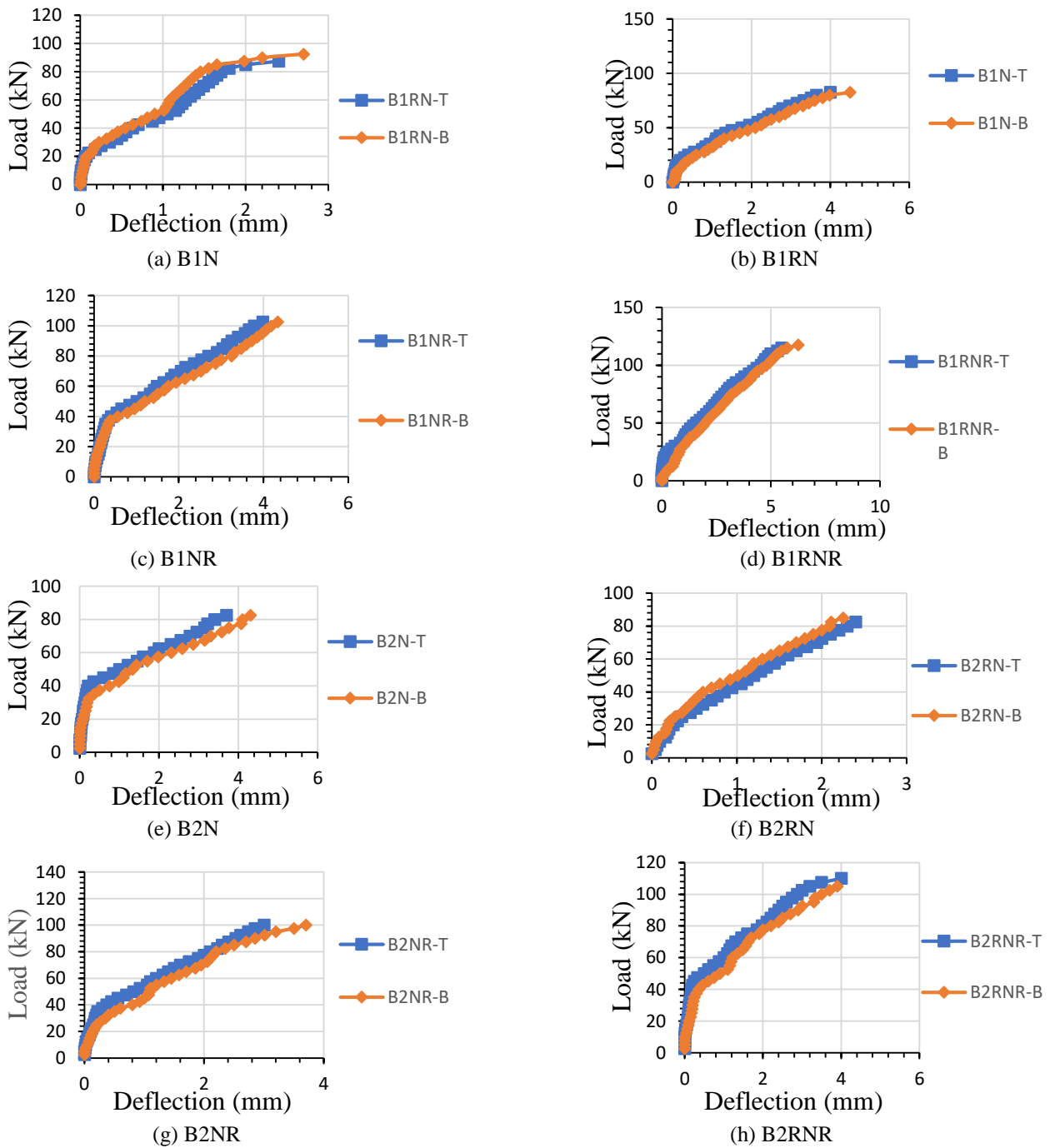

Fig. 22. Load-deflection curve of the corner of opening (T-Top corner, B-Bottom corner).

Table 9
Experimental results of member ductility beams.

Beams	Member ductility ($\mu\Delta$)		
	y (mm)	u (mm)	$\mu\Delta$
B1N	4.81	9.00	1.87
B1RN	3.40	5.40	1.58
B1NR	3.65	7.20	1.97
B1RNR	2.31	11.00	4.75
B2N	3.64	11.00	3.02
B2RN	3.79	7.00	1.84
B2NR	3.90	9.00	2.31
B2RNR	4.00	13.00	3.25
B3N	4.66	13.00	2.78
B3RN	*	*	*
B3NR	3.82	9.00	2.35
B3RNR	2.35	15.55	6.62

* miss date

Table 10
Experimental results of material ductility beams.

Beams	Load		Material ductility ($\mu\epsilon$)		
	P_y (kN)	P_u (kN)	ϵ_y	ϵ_u	($\mu\epsilon$)
B1N	76.35	92.50	2.36	3.01	1.27
B1RN	62.50	94.00	2.36	4.04	1.71
B1NR	70.00	117.50	2.36	6.87	2.91
B1RNR	61.00	129.00	2.36	9.88	4.18
B3N	67.83	77.50	2.36	5.80	2.47
B3RN	*	*	*	*	*
B3NR	60.97	92.50	2.36	6.85	2.90
B3RNR	55.00	101.50	2.36	8.61	3.60

* miss date

because it reduces the stiffness of beams, but the different may be due to the difference in the location of the openings.

4. CONCLUSIONS

Based on the results obtained in the present work from the experimental tests for the tested beams the following conclusions can be drawn:

- 1- When increase number of opening in a reinforced concrete beam within its significantly decreases its stiffness and ultimate strength
- 2- Using RPC in a reinforced concrete beam within its significantly increase its stiffness and ultimate strength.
- 3- It is clearly shown that the cracking load increases when ultimate load increases. The ratio of cracking load to ultimate load (P_{cr}/P_u) was generally between 18% and 30% for same beams This ratio increases with the RPC layer in tension or compression or together. This ratio reduction with increase number of openings.
- 4- All beams with one opening were failed by flexure, Beams with two openings were failed by shear, failed by compound failure flexure and shear in beams with three openings
- 5- The reduction in the ultimate failure loads of the normal beams with two and three openings were 8.1% and 16.21% respectively lesser than those of reference one opening beam.
- 6- The deflection increase with increasing number of opening about (20-40)%. And decrease with increasing number of layer of RCP about (20-47)%.
- 7- Using RPC in two layers in tension and compression are more effective than using RPC in one-layer tension or compression only.
- 8- It can be noticed when increase in the number of openings in the beams causes reduction both ultimate load and their stiffness so causes increase in their deflections.
- 9- It can be noted that the maximum strain is occurred at the bottom edge for all beams The strain increase with increase number of openings.
- 10- The strain increase with increase number of openings because exiting the opening in shear zone and therefore there is weakness in this zone. It can be noted that the maximum strain is occurred at the bottom edge for all beams.
- 11- It can have noted there is an increase and decrease in the ductility despite the presence of RPC may be the reason is the layers that work on the weakness of homogeneity of the beams. In fact, the increase in the number of openings leads to increase in the ductility because it reduces the strength of beams, but the different may be due to the difference in the location of the openings

REFERENCES

- [1] Mansur MA, Kiang-Hwee T. Concrete beams with openings: analysis and design. CRC Press; USA, 1999.
- [2] Mansur MA, Tan K, Weng W. Analysis of reinforced concrete beams with circular openings using strut-and tie model. *The International Conference on Structural Engineering, Mechanics and Computation*, 2001; **11**: p. 311-318.
- [3] Allam SM. Strengthening of RC beams with large openings in the shear zone. *Alexandria Engineering Journal* 2005; **44** (1): 59-78.
- [4] Amiri S, Reza M, Pabarja AA. The study of the effects of web openings on the concrete beams. *Australian Journal of Basic and Applied Sciences* 2011; **5** (7): 547-556.
- [5] El-Maaddawy T, El-Ariss B. Behavior of concrete beams with short shear span and web opening strengthened in shear with CFRP composites. *Journal of Composites for Construction* 2011; **16** (1): 47-59.
- [6] Amiri JV, Hosseinalibygie M. Effect of small circular opening on the shear and flexural behavior and ultimate strength of reinforced concrete beams using normal and high strength concrete. *13th World Conference on earthquake engineering*, Vancouver-2004; 2004.
- [7] Chin S, Shafiq N, Nuruddin M. Strengthening of RC beams with large openings in shear by CFRP laminates: Experiment and 2D Nonlinear Finite Element Analysis. *Research Journal of Applied Sciences, Engineering and Technology* 2012; **4** (9): 1172-1180.
- [8] Code A. Building Code Requirement for Structural Concrete and Commentary (ACI 318M-05). *American Concrete Institute, Farmington Hill, Michigan* 2005.
- [9] New Zealand Standard NZS3101-2part2. Concrete structural standard. C9.3.11; 2006: pp.157.
- [10] ASTM A615. Standard specification for deformed and plain carbon-steel bars for concrete reinforcement; 2009.
- [11] ASTM C191-13, Standard test methods for time of setting of hydraulic cement by Vicat needle. American Society for Testing and Materials, West Conshohocken; USA: 2013.
- [12] Duan L, Cooper TR. Displacement ductility capacity of reinforced concrete columns. *Concrete International* 1995; **17** (11): 61-65.
- [13] Park RL, Park R, Paulay T. Reinforced concrete structures. USA: John Wiley & Sons; 1975.
- [14] Salmon G, Johnson JE, Malhas FA. Steel structures: design and behavior, 4th. Edition Editorial Harper Collins; 1996.