

The Effect of Water Injection and Increasing Humidity of the Combustion Air on the Pollutants Emission from a Continuous Combustion Chamber

Dr. Abdul Kadhim M Hasan Hadi

Mechanical Engineering Department / University of Technology / Baghdad.

Dr. Abdul Sattar Jawad M. Hasan

Mechanical Engineering Department / University of Technology / Baghdad.

Murtadha Shubber Amran

Mechanical Engineering Department / University of Technology / Baghdad.

Received on: 11/6/2014 & Accepted on: 17/9/2015

ABSTRACT

The present work represents an investigation for the pollutants emission when adding water to air in a continuous combustion chamber. Direct water injection into the chamber with water/fuel ratio up to 0.8, as well as, humidifying the inlet air with water prior to the chamber by changing humidity between 20 to 100%, has been examined at different equivalence ratio with gas oil fuel. The results with fuel droplet size of $80\mu\text{m}$ and $\Phi=0.8$, show that when water directly injected, NO_x and soot will decrease by 53% and 56.6% respectively. Nevertheless, CO and UHC are to increase by 108% and 84% respectively. On the other hand, when inlet air has humidified, the decrease in NO_x and soot will be 17.15% and 17.94% respectively. But, CO and UHC show an increase of 13.5% and 8.47% respectively.

Keywords: Water Injection, Pollution, Emissions, Continuous Combustion Chamber.

تأثير حقن الماء و زيادة رطوبة الهواء المشارك في عملية الاحتراق على انبعاث الملوثات من حجرة الاحتراق المستمر

الخلاصة

البحث الحالي يقدم دراسة لانبعاث الملوثات عند اضافة الماء الى حجرة احتراق مستمر. تم حقن الماء مباشرة في حجرة الاحتراق وصولاً لنسبة ماء/وقود قدرها 0.8 ، كذلك ، تم ترطيب هواء الدخول قبل حجرة الاحتراق بتغيير الرطوبة ما بين 20% الى 100% لأختبار أثر ذلك عند نسب مكافئة مختلفة باستخدام زيت الغاز كوقود. أظهرت النتائج باستخدام قطرة وقود قياسها 80 مايكرون عند نسبة مكافئة قدرها 0.8 ، فإن حقن الماء المباشر خفض انبعاث أكاسيد النتروجين والسخام بمقدار 53% و 56.6% على التوالي. غير ان مستويات انبعاث أول أكسيد الكربون و الهيدروكربون غير المحترق قد ازدادت بمقدار 108% و 84% على التوالي. من ناحية أخرى، عند ترطيب هواء الدخول، فالنقصان في أكاسيد النتروجين والسخام اصبح 17.15% و 17.94% على التوالي. لكن، انبعاث أول أكسيد الكربون والهيدروكربون غير المحترق أظهر زيادة بمقدار 13.5% و 8.47% على التوالي لهذه الحالة.

INTRODUCTION

Simply defined, pollution is the wrong substance in the wrong place at the wrong time. The major pollutants are confined to the lowest layer of atmosphere known as troposphere. The main source of atmospheric pollution comes from the combustion of fuels to produce energy for heating and power generation both in the domestic and industrial sectors. The exhaust emissions from the transport vehicles that use petroleum based fuel, waste gases from many industrial sites including chemical plants, electrical power generating stations etc. Produce a huge amount of nitrogen oxides (NO_x), soot, carbon monoxide (CO), and unburned hydrocarbon (UHC) [1]. The efforts now are being focused on studying the formation of pollutants in combustion systems. The ultimate objective of such a study is the prediction of the pollutants levels in the combustion products, leaving practical combustion systems, and to use such predictions to suggest combustion modifications aiming lower emission levels [2]

Tochton ^[3] studied the effect of water and steam injection in the gas turbine combustion chamber using gaseous fuel at different equivalence ratios. It was found that the water or steam injection suppresses the NO_x formation by depressing the peak flame temperature. Other effect of altered mixing is negligible. A comparison was made between water injection and steam injection, showing that the water injection has more effect than steam injection in reducing NO_x and increasing the level of UHC. The greater effectiveness of water over steam injection is explained by the latent heat of vaporization of water to convert it from subcooled liquid to the superheated steam.

Environmental Protection Agency ^[4] studied the injection of water or steam in the burner zone to reduce the peak flame temperature and NO_x will have a detrimental impact on the efficiency of the boiler. The water or steam injected causes reduction in the thermal efficiency of the boiler. The amount of water injected is typically in the range of 20 to 50 percent of the fuel input on a weight basis. Higher injection levels can cause large increase in CO and UHC emissions. The corresponding loss in thermal efficiency when using water is in the range of about 1 to 2.5 percent.

Nishida and Yamada ^[5] investigated the effect of adding water to the combustor. The addition method of water was made by increasing the humidity in combustion air, the detailed characteristics for soot and NO_x reductions were investigated based on the influence of the gas temperature, various species and local equivalence ratio by the addition of water. They found that the amount of both soot and (NO_x) levels in the product were reduced along the both directions (axial and radial) due to reduction of combustion temperature.

Moore ^[6] studied the effect of water direct injection on the gas turbine combustion chamber. It was found that the direct water injection reduced the NO_x and works as a heat sink in the flame, with the aim of reducing the average combustion temperature and reduced thermal NO_x production. This had the added advantage of boosting gas turbine output by increasing the mass flow of gas through the turbine. But gains were offset by the extra fuel required to heat the water to the temperature of the burning mixture, with water fuel mass flow ratios / in the range 1–2 .

Pavri and Moore ^[7] studied the effect of increasing the inlet air humidity and water direct injection prior of the gas turbine combustion chamber type MS7001EA . It was found that increasing the inlet air humidity at ambient pressure of 14.7 psia and ambient temperatures of 59°F/15°C and 90°F/32°C reduced the level of NO_x due to the reduction in combustion temperature. Also, it was found that the water direct injection process increases fuel consumption, reduces the combustion efficiency, and (NO_x) emission, and increases the CO and UHC emission.

Daggett et.al ^[8] studied the effect of direct water injection into the combustion chamber and humidification of the compressor inlet air in the Commercial Aircraft engine combustion chamber. They found in the direct injection method that the reduction in NO_x emissions and the increase in the UHC emissions are higher than those in the increasing the humidity case. The amount of water needed for NO_x reduction compared to the increasing humidity is less. Both techniques result in decreasing the soot emissions via decreasing the combustion air temperature.

Shouse and Roquemore ^[9] showed that fogging of gas turbine inlets or direct injection of water into gas turbine combustors decreases NO_x and increases power. They demonstrated that the injection of water into the air up stream of the combustor reduces NO_x by 30% in a natural gas fueled Trapped Vortex Combustor (TVC) and by 50% in a liquid JP-8 fueled (TVC) for a range in water/fuel and fuel/air ratios.

The present work investigates the effect of techniques, inlet humidification and direct water injection into chamber on the emissions of gas oil fuel burned in a locally fabricated industrial burner. The burner will be examined under various operational conditions in order to promote design and specify the best technique comply with it.

Experimental Work

Figure (1) shows the test rig that is completely manufactured and used in this study. The liquid fuel is stored in fuel tank and forced in fuel injection system by compressed air, which is supplied by reciprocating compressor. Compressed air is also used to atomize the liquid fuel in order to generate very small size droplets. The liquid fuel is directly sprayed into combustion chamber via the four-point air blast atomizer and measured by using liquid flow meter. The main air flow from the blower is forced through nine holes surround the atomizer as show in figure(2) and measured by using differential pressure method (orifice plate). The test rig includes water injection system in which the water can be injected inside the combustion chamber at the point 1cm after air blast atomizer by using water injector having a diameter of 0.2 mm and the amount of injected water can be measured by using water flow meter having range from 0 to 10 liters per hour and adjusted by using water valve. Also the water injection system injects water in the mixing box to increase the humidity of the combustion air. The mixing box includes air heater to enhance the water droplets evaporation process. The air temperature can be controlled by using voltage regulator to adjust the voltage passes through the heater. The humidity of the combustion air is measured by humidity meter which is installed at the point before air blast atomizer. The size of fuel droplets in the spray can be reduced by increasing the atomization pressure of air supplied to the air blast.

The amount of air used in atomization is measured by using air flow meter, and its pressure measured by Borden gauge. Knowing the amount of air and fuel which participate in combustion process leads to calculate the overall equivalence ratio Φ_V . The average equivalence ratio Φ represents the area weighted value that determined by integration according to the local air velocity and the fuel sprayed at the flame front position where most of the air is entrained within the fuel spray, as shown in appendix (A).

A small (10 mm diameter) air-LPG pilot flame which is continuously sustained, and serves as an igniter source for the main fuel-air spray mixture as show in figure (2). Carbon monoxide, nitrogen oxides and unburned hydrocarbon emissions are measured by using exhaust gas analyzer as shown in figure (1), while soot emission is measured by using smoke-meter as shown in figure (3-B).

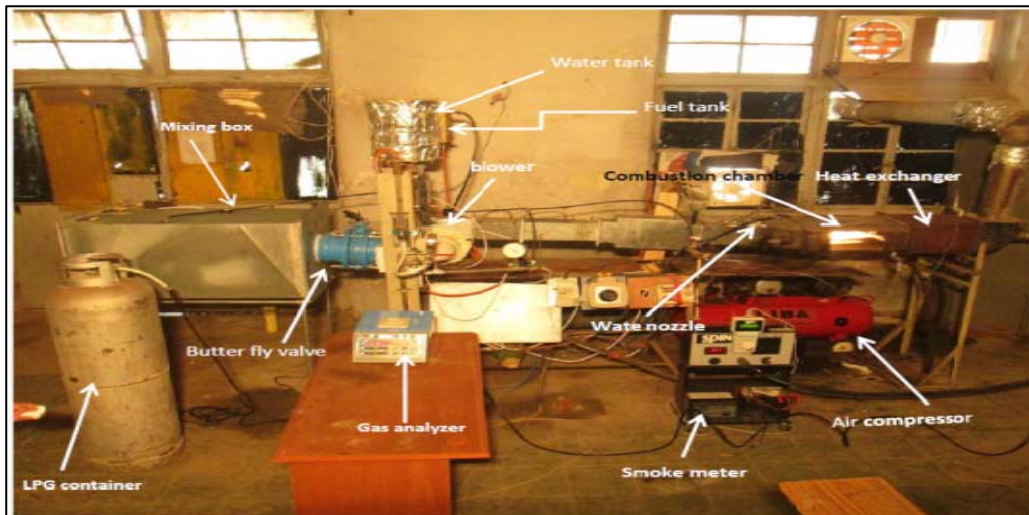

Figure (1): The Test Rig.

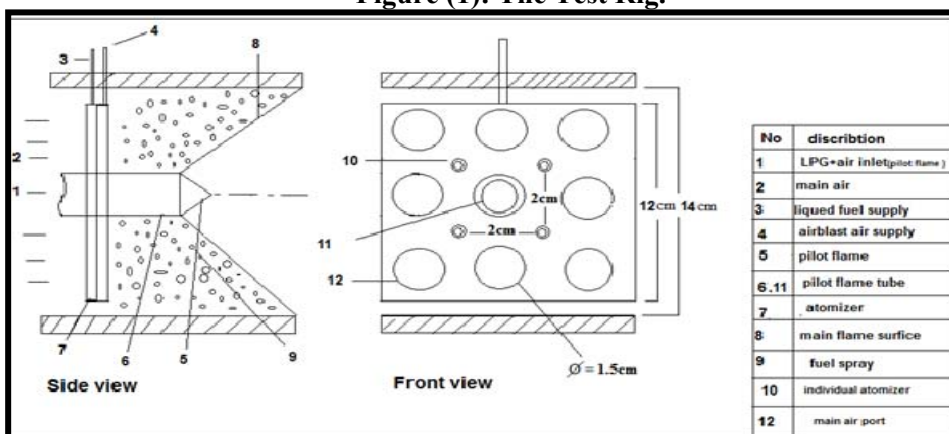

Figure (2): Schematic diagram of flame holder.



Figure (3): Gas analyser and Smoke meter devices.

Results and Discussion:

Experiments were conducted on gas oil fuel burned in a continuous combustion chamber to study the effect of water injection and increasing the humidity of the combustion air on pollution emissions.

Direct water injection:

When injecting very fine water droplets in combustion chamber flame by water injector, the water droplets evaporate. The heat required to convert the water droplets from the liquid state to steam will be absorbed from the flame itself and in this situation the flame temperature will be reduced. Therefore the chemical reaction will be reduced and as a result the CO and UHC emissions increasing but the soot and NO_x emissions are decreasing [3,4,6, 7,8]. When increasing the amount of injected water the degradation in flame temperature will be increased and as a result the reduction in soot and NO_x emissions is increased and the concentrations of CO and UHC emissions is increased.

Figures (4) and (5) show that for gas oil fuel when increasing the ratio of water to fuel to 0.8, the corresponding increase in the CO and UHC concentration is (95.57%, 82.27%) respectively, at $\Phi=0.8$ and fuel droplet size 80 μm . This behavior of CO and UHC emission is attributed to that the water injection causes flame cooling because the injected water will be converted to steam directly and extracted the latent heat of evaporation from the flame, so that the flame temperature will drop causing CO and UHC concentrations to increase [3,4,7,8].

Figure (6) manifests the inverse proportionality of NO_x emissions with increasing the ratio of water to fuel. When increasing the ratio of water to fuel to 0.8, the NO_x emissions decreases by (38.48%) at $\Phi=0.8$ and fuel droplet size 80 μm . This behavior of NO_x is caused by the evaporation of injected water which causes flame cooling because of the water droplets work as a heat sink reducing the combustion temperature [3,4,6,7,8].

Figure (7) manifests the inverse proportionality of soot emissions with increasing the ratio of water to fuel. When increasing the ratio of water to fuel to 0.8, the soot emissions decreases by about (56.64%) at $\Phi=0.8$ and fuel droplet size 80 μm . This behavior of soot is ascribed to the evaporation of injected water droplets which reduce the combustion temperature so that the reaction rate will be reduced at the rich zone [8].

Humidification of inlet air:

As the combustion air humidity is increased by spraying very fine water droplets in the inlet air stream, in this situation the inlet air temperature is decreased because of the latent heat of evaporation of the droplets. Water used to convert these droplets to steam will be absorbed from the combustion air. The saturated steam in the humid combustion air will be converted later to super-heated steam during the combustion process, taking the heat required for this conversion from the flame heat content. Due to increasing the combustion air humidity, the CO and UHC emissions are increased slightly, but the soot and NO_x emissions are decreased [5,7,8,9].

Figures (8) and (9) show that when increasing the combustion air relative humidity, the CO and UHC concentration will be increased by (13.55%, 8.478%) respectively, at $\Phi = 0.8$ and fuel droplet size 80 μm . This behavior of CO and UHC emissions is attributed to the high level of humidity in combustion air that causes flame cooling [7].

Figure (10) shows the inverse proportionality of NO_x emissions with increasing the combustion air relative humidity. When increasing the combustion air relative humidity the NO_x emissions decrease by (17.15%) at $\Phi=0.8$ and fuel droplet size 80 μm . This behavior of NO_x is ascribed to the high concentration of humidity in combustion air which suppressed the combustion temperature because of the water vapor in humid air works as a heat sink [7,8,5,9].

Figure (11) shows that the trend of soot emissions is similar to that of NO_x. When increasing the combustion air relative humidity, the soot emissions decreased by (17.94%) at $\Phi=0.8$ and fuel droplet size 80 μm . This behavior of soot is ascribed to the increases in the humidity which reduce the reaction rate at the rich zone [8].

CONCLUSIONS

The results obtained through the experiments show that NO_x and soot are generally decreased while CO and UHC are increased with increasing the amount of water added to the combustion air in both the techniques studied here. But, as indicated earlier, the emissions levels seem to be preferable for inlet humidification compared to that for direct water injection. The emission of CO is about eight times higher, while UHC emission is about ten times higher with direct injection than that to be emitted in inlet humidification for just a moderate reduction in NO_x and soot emission. More effort should be done to promote the burner design in order to make better utilization of air and water introduction into chamber.

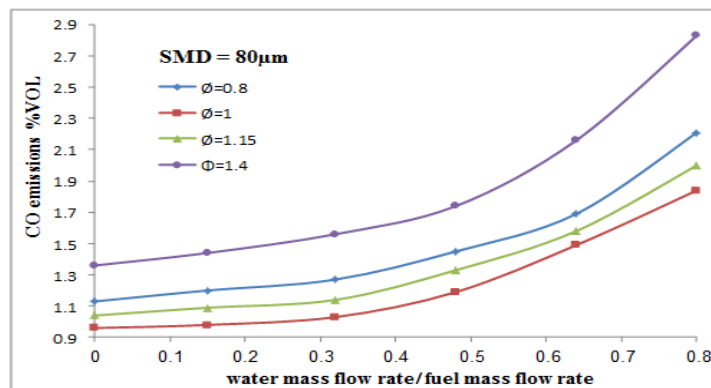

Figure (4) CO emission with increasing water/fuel ratio at different equivalence ratio

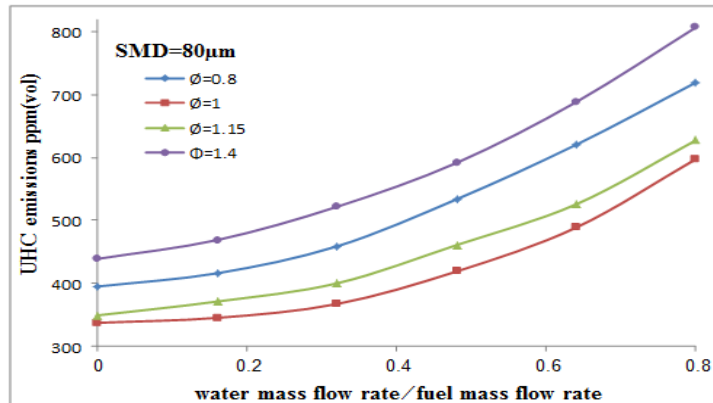

Figure (5) UHC emission with increasing water/fuel ratio at different equivalence ratio

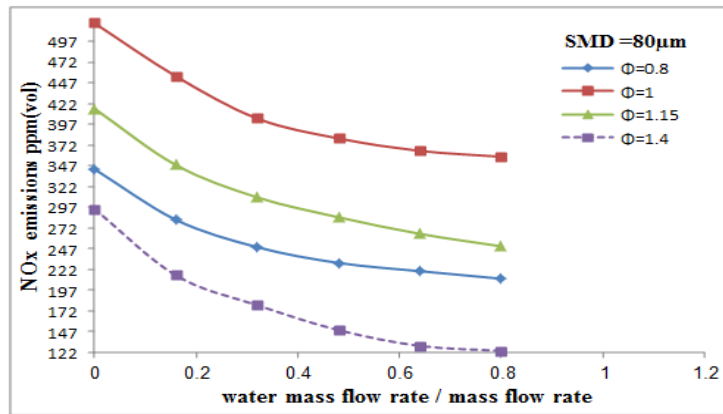

Figure (6) NO_x emission with increasing water/fuel ratio at different equivalence ratio

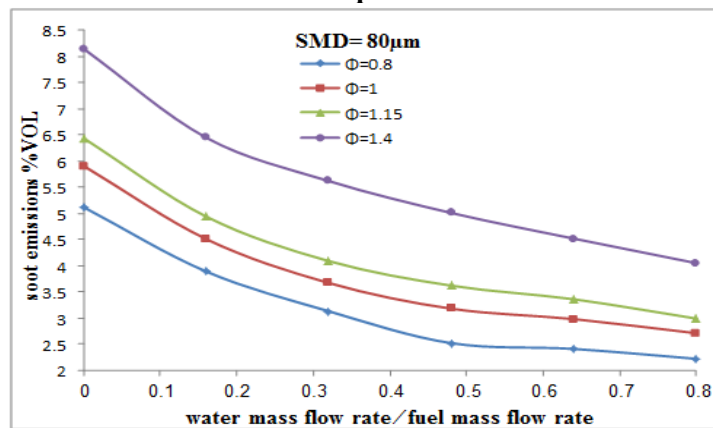

Figure (7) Soot emission with increasing water/fuel ratio at different equivalence ratio

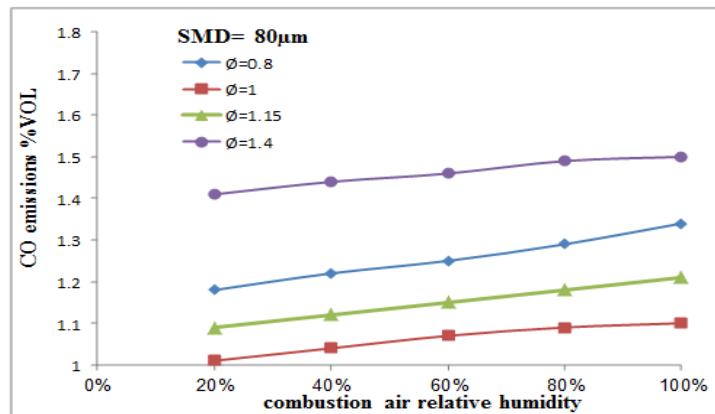

Figure (8) CO emission with increasing inlet air humidity at different equivalence ratio

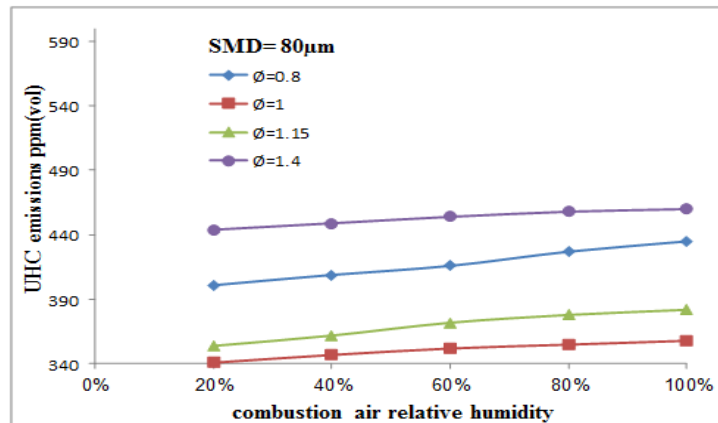

Figure (9) UHC emission with increasing inlet air humidity at different equivalence ratio

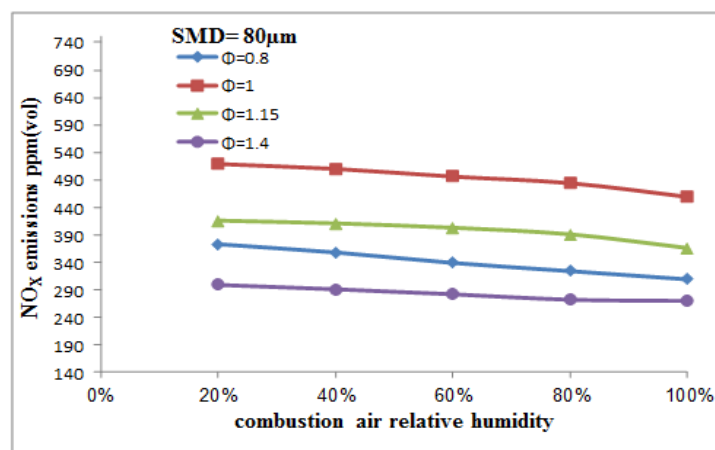

Figure (10) NO_x emission with increasing inlet air humidity at different equivalence ratio

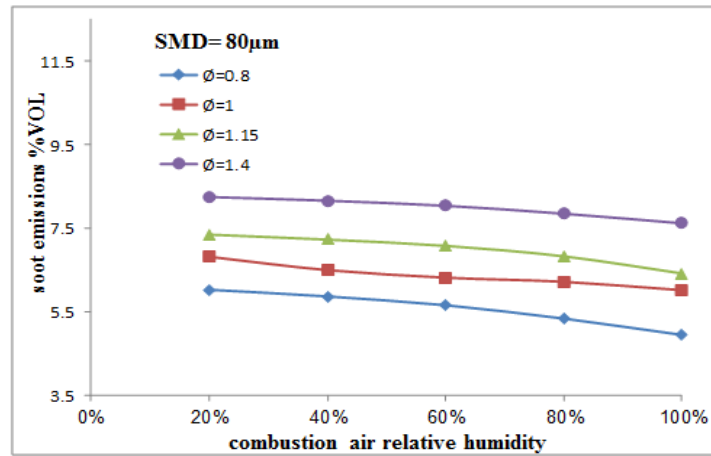
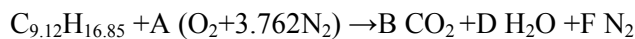

Figure (11) Soot emission with increasing inlet air humidity at different equivalence ratio

Appendix (A)

Calculation of theoretical A/F for gas oil fuel.



- Balance for carbon
Hence, B=9.12
- Balance for hydrogen
Hence, D=8.425
- Balance for oxygen
Hence, A=13.3325
- Balance for N₂
Hence, F=50.15

$$(A/F)_{stoich} = \frac{13.3325(32 + 3.762 * 28)}{12 * 9.12 + 16.85} = 14.4986$$

Calculation of the amount of the main air :

The amount of the main air is calculated from the following equation:

$$V = K\sqrt{h}$$

Where:

K=constant = 21×10^{-3} , and h=monometer reading in mmH₂O

At h = 0.3 mm H₂O $\rightarrow V = 21 \times 10^{-3} \times \sqrt{0.3} = 0.0115 \frac{m^3}{sec}$

Either with respect to the mass of air

$$m = \rho \times V$$

At main air = 0.3 mmH₂O $\rightarrow m = 1.19 \times 0.0115 = 0.013685 \frac{kg}{sec}$

Calculation of the atomization air:

At scale flow meter = 1 → $m_{ab} = 1.19 \times 4 \times \frac{10^{-3}}{60} = 7.93 \times 10^{-5} \frac{kg}{sec}$

The table below shows the ratio of the atomization air to the main air:

Atomization air Main air	7.93×10^{-5}	1.19×10^{-4}	1.58×10^{-4}	1.98×10^{-4}
0.013685	5.8×10^{-3}	8.695×10^{-3}	0.0116	0.0145
0.01666	4.7599×10^{-3}	7.14×10^{-3}	9.53×10^{-3}	0.0119
0.019278	4.11×10^{-3}	6.172×10^{-3}	8.24×10^{-3}	0.0103

The maximum ratio of air used in the atomization to the main air is

$Air\ ratio = \frac{1.985 \times 10^{-4}}{0.013685} = 0.0145$

Hence, the air used in the atomization may be neglected

Calculation of the amount of gas oil fuel:

$m_f = \rho \times V_f$

At fuel scale = 2 → $m_f = 840 \times 0.042 \times 10^{-3} \times \frac{1}{60} = 5.8 \times 10^{-4} \frac{kg}{sec}$

Calculation of the equivalence ratio:

At $m_f = 5.8 \times 10^{-4} \text{ kg/sec}$ and $m_{air} = 0.013685 \text{ kg/sec}$

$\Phi_v = \frac{14.4986}{\frac{0.013685}{5.8 \times 10^{-4}}} = 0.6144$

$\Phi = 1.9214 \times \Phi_v = 1.9214 \times 0.6144 \approx 0.79$

Appendix (B)

The table below indicates the Properties of the local gas oil fuel used in this study ^[10]

Equivalent Chemical formula	C _{9.12} H _{16.85}
Surface tension (σ) kg/s ²	0.0267
H/C ratio	1.84
Specific gravity @15.4°C(max)	0.85
Flash point (abel) °C (min)	54
ViscosityCst @40°C (max)	5.6
Calorific value Kcal/kg (gross)EST	10800
Nitrogen content	-
Sulphur content	1%W(max)

REFERENCES

- [1].A.K .Raja ,Amit Prakash Srivastava and Manish Dwivedi , " Power plant engineering " , First edition , New Delhi , pp:414, 2010.
- [2].Richard C. Flagan and John H. Seinfeld
"Fundamentals of air pollution engineering", First edition, California institutes, pp: 98-99-102-167-215, 1988.
- [3].G.L.Touchton," Influence of gas turbine combustor design and operation parameters on effectiveness on NO_x suppression by injected steam or water" , Transaction of the ASME, Vol . 107, July, 1985.
- [4].U. S. Environmental Protection Agency, "alternative control technologies document NO_x emissions from utility boilers ", Office of Air and Radiation, Office of Air Quality Planning and Standards, Research Triangle Park, North Carolina 27711, 1994 .
- [5].Osami Nishida and Naoki Yamada, "Effects of water addition into air or fuel on flame structure, soot and NO_x formation/decomposition in diffusion flames" ,Translated from Journal of the MESJ Vol. 30, No. 3 ,1994 .
- [6].M j Moore, " NO_x emission control in gas turbines for combined cycle gas turbine plant ", Proc Instn Mech Engrs Vol 211, Part A, Guildford, Surrey, 1997.
- [7].Roointon Pavri and Gerald D. Moore. 2003,"Gas turbine emission and control", GE Power Systems, 03/01.
- [8].David l. Dagette et al , " Revisiting water injection for commercial air craft ",The Boeing Commercial Airplane Group , Rolls-Royce Corporation and NASA Glenn Research Center, 2004 .
- [9].N. J. Friswell , " The influence of fuel composition on smoke emission from gas turbine : effect of combustor design and operating conditions" , Shell Research Limited. Thornton Research Centre. PO. Box 7. Chester CH7 3SH. England, Combustion Science and Technology, Vol. 19, pp, 119-127, 1979.
- [10]" Marketing Specification of Iraqi Petroleum Products " , Ministry of Oil, Republic of Iraq, 2000.