

Preparation and characterization of zinc oxide nanoparticles by laser ablation of zinc in isopropanol

The 5th International Scientific Conference for Nanotechnology and Advanced Materials and Their Applications ICNAMA 2015 (3-4) Nov.2015

Fattin Aabdulameer Fadhil

Applied Science Department, University of Technology/ Baghdad.

Iman Hassan Hadi

Applied Science Department, University of Technology/Baghdad.

Abstract

In this work preparation and characterization of a zinc metal target in isopropanol liquid at room temperature is carried out by PLAL technique at different laser fluency. The effect of laser fluencies during laser ablation process on the structure properties of the NPs is investigated.

We have use UV-visible spectroscopy, Atomic force microscopy and Energy dispersive X-ray (EDX) was used to evaluate the bulk atomic composition of NPs. The absorption peak of samples prepared in isopropanol solution is seen to be substantially blue shifted relative to that of the bulk zinc oxide due to the strong confinement effect. The technique offers an alternative for preparing the nanoparticles of active metal. The morphological investigation, carried out using (AFM), showed that the root mean square roughness is increased and the grain size of the obtained NPs are found to increase with the laser fluency. The use of isopropanol as solvent yielded spherical nanoparticles of 30–60 nm.

Key word: Ablation in liquid, Nanoparticles, PLAL, Optical and structure properties.

تحضير ودراسة خصائص اوكسيد الزنك النانوية بواسطة الاستئصال المحتث بالليزر للخارصين في الايزوبروبونال

الخلاصة:

في هذا البحث تم تحضير ودراسة خصائص اوكسيد الزنك النانوية بواسطة الاستئصال المحتث بالليزر في الوسط السائل وبكثافة طاقات ليزر مختلفة. حضر اوكسيد الزنك من معدن الزنك في محلول الايزوبروبونال في درجة حرارة الغرفة حيث تم دراسة تأثير طاقات الليزر اثناء عملية الاستئصال على الخصائص البصرية والتركيبية للمادة الناتجة. تم استخدام جهاز مطياف الامتصاص (UV-visible)، ومجهر القوة الذرية (AFM)، وجهاز تشتت الطاقة (EDX) لدراسة الخصائص البصرية والتركيبية للمواد النانوية. حيث اظهرت نتائج الخصائص البصرية حدوث ازاحة نحو الاطوال الموجية القصيرة مقارنة بمادة اوكسيد الزنك في الحالة الصلبة. تم ايضا فحص طوبوغرافية السطح باستخدام مجهر القوة الذرية (AFM) ووجد ان خشونة السطح والحجم الحبيبي للمادة النانوية المحضرة تزداد بزيادة كثافة طاقات الليزر المستخدمة. ادى استخدام محلول الايزوبروبونال الى تكوين جسيمات نانوية كروية الشكل تتراوح اقطارها ما بين 30-60 نانومتر.

INTRODUCTION

The Pulsed laser ablation in liquid media (PLAL) is an emerging technique in material science for fabricating metal and metal-oxide nanoparticles [1]. The preparation of metal nanoparticles by laser ablation in a liquid environment has recently attracted much attention [2]. Crystallized oxide nanoparticles can be easily obtained at room temperature by this method. The advantages of the PLAL technique are inexpensive equipment for controlling the ablation atmosphere, simplicity of the procedure, and the minimum amount of chemical species required for synthesis compared to the conventional chemical process [3]. The unique feature of laser ablation in liquid is the formation of dense plasma which brings about local and temporal non-equilibrium conditions. Accordingly, not only the chemical environment but also physical parameters including laser power and spot size, wavelength, and ablation time determine the characteristics of the resultant nanoparticles. In this respect, it will be certainly beneficial to verify the influence of such parameters not only for producing high-quality nanoparticles but also for deep understanding of the physical processes [4]. Zinc oxide is a widely studied II-VI semiconductor with a large direct band gap of 3.37 eV and large exciton binding energy of 60 meV. Excitonic UV emission at room temperature makes it a promising candidate for optoelectronic applications. ZnO nanoparticles have been investigated widely as an emission material because nanocrystallization can enhance the optical and electrical properties of wide-gap semiconductors by the quantum confinement effect [3].

Experimental work

ZnO nanoparticles were produced by laser ablation of a Zn target (diameter = 5 cm, thickness = 4.0 mm, purity 99.99%) placed on the bottom of a glass vessel filled with 2.5 ml of isopropanol solution. The Zn target was irradiated vertically by a Q-switched Nd-YAG laser type (HUAFGI), ($\lambda = 1064$ nm, pulse width of 10 ns, repeating frequency of 1 Hz, and energy from (100-650) mJ as showing in Fig (1). Effective beam diameter of (2.06) mm for 1064 nm was used for laser ablation. The laser is applied with a convex lens with (110 mm) focal length to achieve high laser fluence. The vessel was continuously rotated to minimize the target aging effect and to give some stirring effect during the formation of nanoparticles. The surface morphology, particle size distributions and root mean square of roughness of zinc oxide nanoparticles prepared under various conditions were analyzed using atomic force microscope (AFM) model (AA3000). Energy dispersive X-ray (EDX) model (FESEM, SUPRA TM 35 vp Zeiss, Germany product, Malaysia university) was used to evaluate the bulk atomic composition of NPs. For these measurements some drops of colloids drop casted onto single crystal silicon. All above measurements are carried out at room temperature. A double-beam UIR-210A spectrophotometer from Shimadzu model (SE 7200) was used in order to investigate the optical absorption spectra of the zinc oxide colloidal NPs at different preparation conditions within the spectral range (300-420 nm).

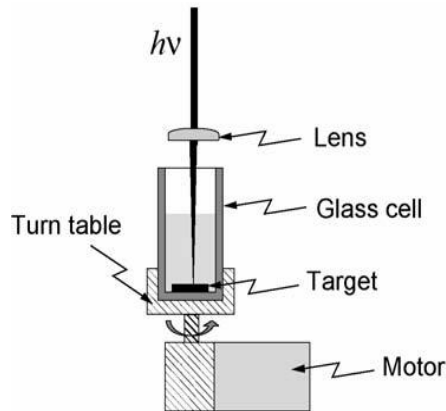

Figure (1) Schematic illustration of pulse laser ablation in liquid (PLAL).

Results and discussion

Fig. 2 shows the UV–vis optical absorption spectra of the colloidal suspensions. ZnO exciton absorption peaks locating at 346 nm. These peaks have a slightly red shift with the increase of laser fluency, implying that the product corresponding to low laser fluency has a much smaller size. The optical band gap was estimated from the absorption onset at 346 nm by drawing tangent to the curve in isopropanol. The absorption peaks of ZnO can be used to estimate particle size following effective mass approximation. Increasing the laser fluency leads to increases the particle size except for ZnO NPs ablated with different laser fluency [5].

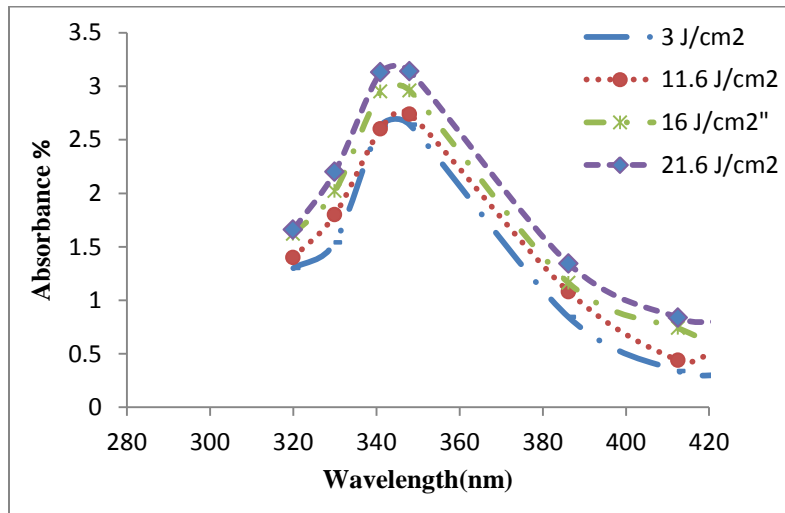

Figure (2) UV-visible absorption spectrum of colloidal solution of nanoparticles obtained by laser ablation in isopropanol at different laser fluencies 3 J/cm², 11.6 J/cm², 16 J/cm², and 21.6 J/cm²

Actually, increasing laser fluency means delivering more energy implies ablating larger amount of material. It was noticed that increasing laser fluency produced plasma plume becomes more intense, and the ZnO nano colloidal particles could become denser. This gives an indication that bigger particles will be produced due to two facts. The first is due to longer growth time and the second fact is due to high probability of cluster aggregation. On the other hand, sound generated by break down of water was detected at high laser fluency [6]. The plot of $(\alpha h\nu)^2$ versus $h\nu$ plot of ZnO NPs prepared at laser fluency 11.6 J/cm^2 is (3.7 eV) as shown in Fig.3.

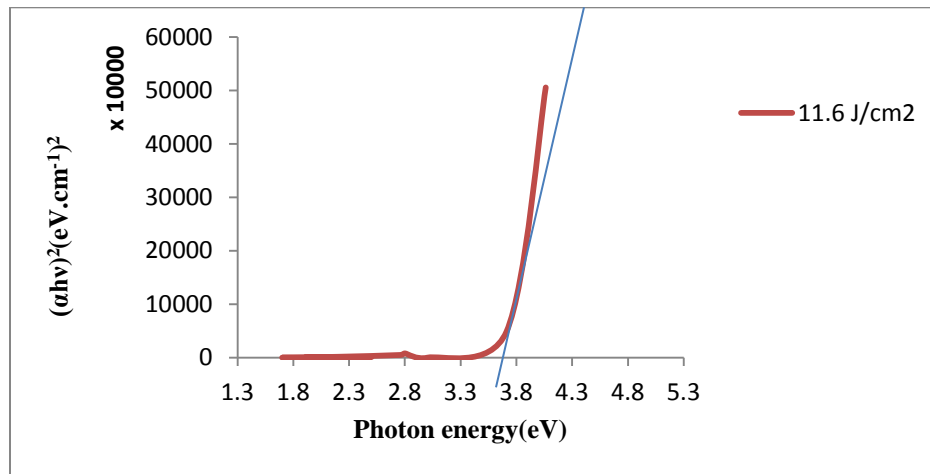

Figure (3) The $(\alpha h\nu)^2$ versus $h\nu$ plots for ZnO NPs prepared at 11.6 laser fluency.

Fig. 4 shows the 2D and 3D AFM images of zinc oxide colloidal NPs prepared under various values of laser fluency. The results show that there is a great influence of the laser fluency value on the forming morphology of the synthesized nanoparticles. Table 1 presents the RMS and average nanoparticle diameter as function of laser fluency.

As illustrated in (Fig.4 a), in the case of low laser fluency, the plasma plume is weak and has a relatively low temperature and pressure, in addition to space distribution of laser power and environmental disturbance, inhomogeneous density distribution in plasma plume becomes more obvious. [7]. contrarily as shown in Fig. (4 c) at high laser power, the plasma plume is intense, ensuring a longer plasma lifetime and a higher temperature and pressure in the plasma plume. The plasma at medium laser fluency as shown in Fig. (4 b) would be of moderate states between the above two, which resulted in the spherical nanoparticles as our previous report [8]. The increase in particles size with increasing laser fluency is attributed to the effect of laser fluency on the states of plasma during the laser ablation process in liquid. It has been demonstrated that the size of ZnO NPs produced in isopropanol increases with increasing laser pulse energy [9]. The ablation in isopropanol yielded spherical nanoparticles in the range of 30-60 nm. The variation in size distribution of nanoparticles may be due to the different absorption coefficient of the

solvent of the ablating laser light (1.06 nm), fluency and/or to different chemical reaction occurring in the solvent used for synthesis.

The ablation in isopropanol yielded spherical nanoparticles in the range of 30-60 nm. The variation in size distribution of nanoparticles may be due to the different absorption coefficient of the solvent of the ablating laser light (1.06 nm), fluency and/or to different chemical reaction occurring in the solvent used for synthesis [10].

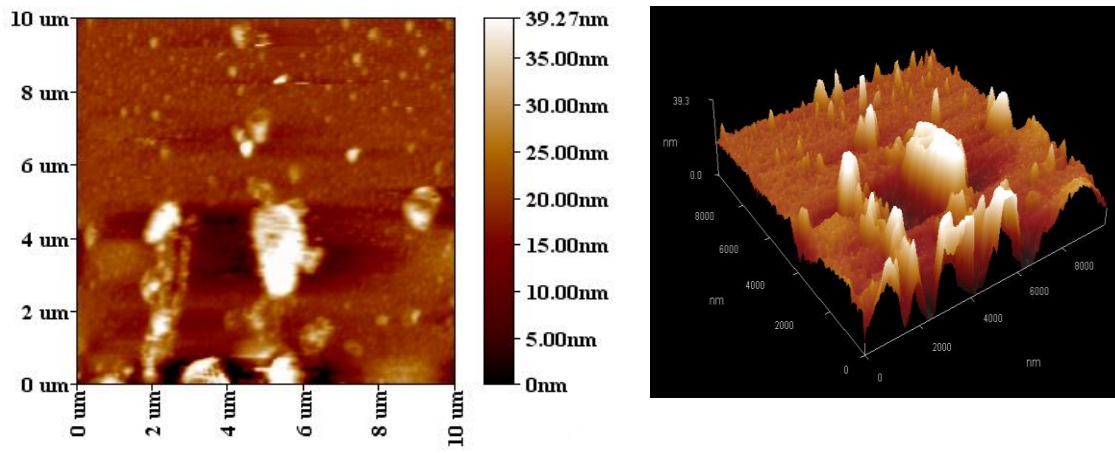

(a)

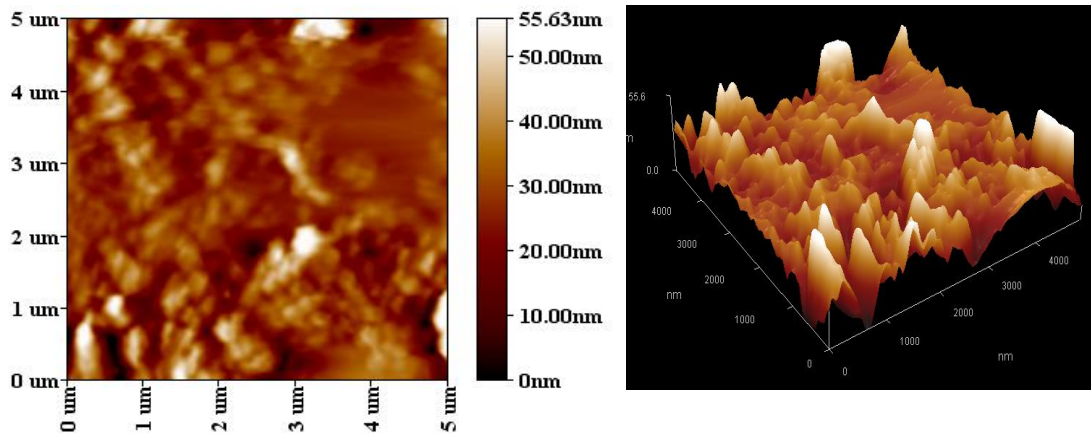

(b)

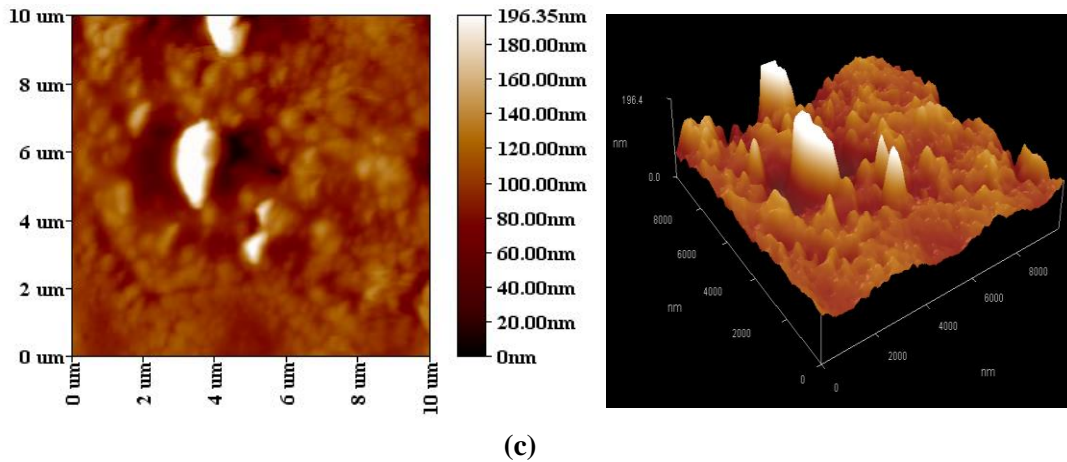

Figure (4a, b, c) 2D and 3D AFM images of ZnO NPs prepared at different laser fluencies (a=3, b=11.6, and c=21.6 J/cm²)

Table (1): Listed the RMS, average size and Sz of ZnO NPs at different laser fluencies.

laser fluency (J/cm ²)	Avg. Diameter (nm)	RMS (nm)	Sz (nm)
3	36.80	2.97	24.6
11.6	54.39	4.23	30.1
21.6	244.14	26.6	211

EDX investigation has been used to confirm the formation of ZnO NPs. The EDX spectra of ZnO presented in Fig. 5 exhibits well defined peaks for ZnO, one can clearly see three peaks located between 1 and 8.5 kV. Those maxima are related to oxygen, zinc and silicon. The results of EDX analysis ablated of NPs prepared at 11.6 J/cm².

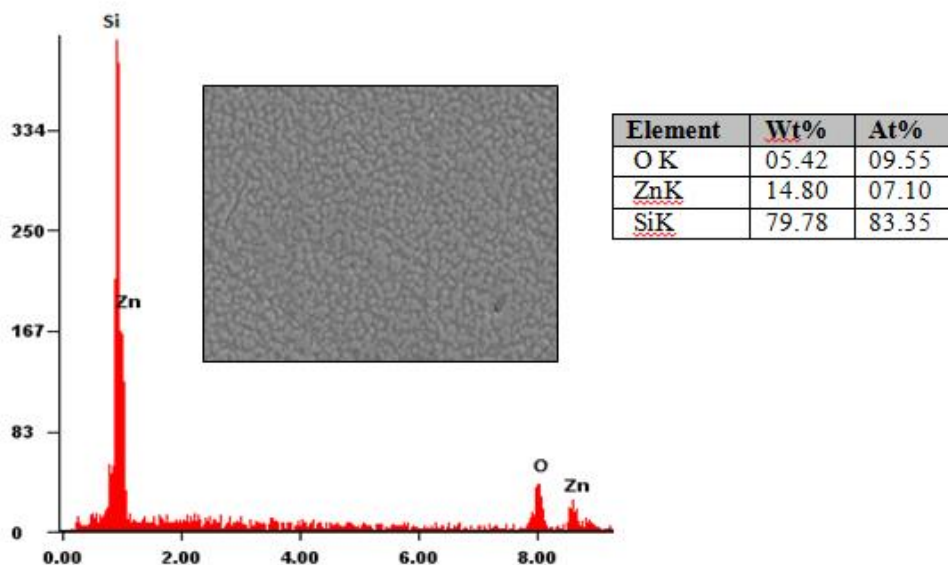

Figure (5) EDX spectrum for ZnO NPs synthesized on silicon at 11.6 J/cm^2 , inset is the SEM of NPs

Conclusions

In conclusion, a study of zinc oxide NPs prepared by laser ablation of zinc target in isopropanol at different conditions is presented for the first time. The grain size of ZnO NPs is increased as laser fluency increasing, the values of optical band gap for ZnO NPs are larger than that for bulk ZnO, quantum size effect is observed. AFM and EDX observation on the grown NPs reveal that significant evidence of large particles is found after increasing in laser fluency.

Reference

- [1] T. Sasaki, C. Liang, W. T. Nichols, Y. Shimizu, N. Koshizaki "Fabrication of oxide base nanostructures using pulsed laser ablation in aqueous solutions", Appl. Phys. A, vol. 79, pp. 1489- 1492, 2004.
- [2] G. W. Yang, "Laser ablation in liquids: Applications in the synthesis of nanocrystals", Progress in Materials Science, vol. 52, pp. 648–698, 2007.
- [3] T. Sasaki, Y. Shimizu, N. Koshizaki, "Preparation of metal oxide based nanomaterials using nanosecond pulsed laser ablation in liquids", J. Photochem and Photobio A: Chem, vol. 182, pp. 335- 341, 2006.
- [4] Jeong Moon Cho, Jae Kyu Song,* and Seung Min Park* "Characterization of ZnO Nanoparticles Grown by Laser Ablation of a Zn Target in Neat Water" Bull. Korean Chem. Soc., Vol. 30, No. 7, 2009

- [5] J. Moon Cho, J. Kyu Song, and S.Min Park "Characterization of ZnO Nanoparticles Grown by Laser Ablation of a Zn Target in Neat Water" Bull. Korean Chem. Soc., (2009), vol. 30, No. 7.
- [6] Raid A. Ismail • Abdulrahman K. Ali • Mukhlis M. Ismail • Khaleel I. Hassoon "Preparation and characterization of colloidal ZnO nanoparticles using nanosecond laser ablation in water" Appl Nanosci 1:45–49, 2011.
- [7] Hosono E, Fujihara S, Honma I, Zhou HS. Adv Mat" laser power effect on morphology and photoluminescence of ZnO nanostructure type" (2005), 17:2091–4.
- [8] Xi Zhang, Haibo Zeng, Weiping Cai "Laser power effect on morphology and photoluminescence of ZnO nanostructures by laser ablation in water", Materials Letters , (2009), Vol.63, pp.191–193.
- [9] Y.S.choi,J.Y.lee.S.I.M. "Dynamic and static photo-response of n-ZnO/Si photo diod" Jpn.J.Appl.phys.,(2003), Vol.42, pp.1560-1562.
- [10] R.K. Thareja , Shobha Shukla" Synthesis and characterization of zinc oxide nanoparticles by laser ablation of zinc in liquid" Applied Surface Science (2007),Vol. 253, pp.8889–8895.