

Numerically and Theoretically Studying of the Upper Composite Complete Prosthetic Denture.

Dr. Jawad K. Oleiwi 

Materials Engineering Department, University of Technology/Baghdad.

Dr. Sihama I. Salih

Materials Engineering Department, University of Technology/Baghdad.

Qahtan A. Hamad

Materials Engineering Department, University of Technology/Baghdad.

Email: qah84@yahoo.com

Received on: 15/1/2015 & Accepted on: 7/5/2015

Abstract

The current study focused on the manufacturing and development properties of upper prosthesis complete denture from composite materials with the basis cold cured resin of poly methyl methacrylate as new fluid resin and reinforced materials by two different types of particles (nano-hydroxyapatite (nHA), micro zirconia (ZrO_2)), that added with different volume fractions of (1%, 2% and 3%), and the different types of woven fibers (Glass fiber, Kevlar fiber), it were added with a fixed volume fraction of (5%) to PMMA composites. Specimens' consist of a six groups where prepared by using (Hand Lay-Up) method from the composites materials and hybrid laminated composites materials. This research includes theoretical and numerical studies by using finite element method to confirming the experimental results of the effect of selected volume fractions of these particles and fibers on the (total deformation distribution, equivalent elastic strain and equivalent Von Mises stress) of the composite prosthetic dentures.

The theoretical part included calculations the values of theoretical safety factor and Poisson's ratio. While the numerical part based on finite element method (F.E.M), which was performed by using program (ANSYS-15) to analyze the prepared of denture composite materials and evaluate its characteristics which represent total deformation distribution, equivalent stress and equivalent elastic strain. This was performed by obtaining twenty one models for the PMMA composite dental prostheses which were treated as three dimension structure. The numerical results of the F.E.A showed coincided with some of the experimental results.

Key words: Composite materials, PMMA polymer, H.A particles, ZrO_2 particles, Glass Fibers, Kevlar Fibers, Poisson's ratio, Safety factor, (ANSYS-15) program.

دراسة تحليلية ونظرية لطقم الاسنان الاصطناعي الكامل المترابك العلوي

الخلاصة

في هذا البحث تم التركيز على تصنيع وتطوير مواصفات طقم أسنان اصطناعي كامل علوي من مواد مترابكة. وقد حضرت هذه المواد المترابكة من راتنج البولي مثيل ميثا اكريليت على شكل راتنج سائل جديد معالج ذاتياً كمادة أساس وقد تم تقويتها بنوعين مختلفين من الدقائق تضمنت دقائق الهيدروكسي اباتايت النانوية ودقائق الزركونيا الميكروية تم اضافتهما بكسور حجمية مختلفة هي (1%، 2% and 3%)، ونوعين مختلفين من الألياف الحصرية الثنائية الاتجاه هي الياق الزجاج والياق الكفلر والتي تمت اضافتها الى المواد المترابكة بكسر حجمي ثابت هو (5%) الى المواد المترابكة. تتكون العينات من ستة مجاميع تم تحضيرها باستخدام طريقة الصب اليدوي تمثل مواد مترابكة ومواد مترابكة طباقية هجينة. تضمن البحث دراسة نظرية وتحليلية باستخدام طريقة العناصر المحددة للتأكد من النتائج العملية لتأثير الكسور الحجمية المختارة لهذه الألياف والدقائق على (توزيع التشوه الكلي، الانفعال المرن المكافيء والاجهاد المكافيء) لأطواق الاسنان الاصطناعية المترابكة. تضمنت نتائج الجانب النظري حساب قيم معامل الامان النظري ونسبة بوزن. أما الجانب التحليلي فيتضمن استخدام استخدام طريقة العناصر المحددة والتي أنجزت باستخدام برنامج (ANSYS-15) لغرض تحليل المواد المترابكة المحضرة لطقم الأسنان وحساب خصائصه والتي تمثل (توزيع التشوه الكلي، الاجهاد المكافيء والانفعال المرن المكافيء)، وقد تم انجاز ذلك عن طريق الحصول على واحد وعشرون موديل لطقم الاسنان الاصطناعي باعتبارها أطواق أسنان مترابكة مكونة من راتنج البولي مثيل ميثا اكريليت ذات هيكل ثلاثي الابعاد، وقد أظهرت النتائج التحليلية لطريقة العناصر المحددة تطابق مع بعض النتائج العملية.

INTRODUCTION

The poly (methyl methacrylate) (PMMA) is most widely used in denture base construction. The first PMMA-based self curing polymer (PMMA) was developed as early as in (1938). In an attempt but they have not been shown to produce dentures of greater accuracy or better performance, some researches which are accomplished in this field it's: [1].

Hamid, studying a two dimensional F.E.M was applied to study the stress distribution in the upper complete denture using monsoon and antimonsoon theory. The result showed stress concentration at the palatal sides. These stresses decreased gradually when cusp angulations decreased [2].

Takayama et. al., studying analyzed the dynamic behavior of a complete denture during unilateral load using the F.E.M. The F.E.M consist of the body of the mandible, alveolar mucosa, and a complete denture, it could simulate the contact between the mucosa and the tissue surface of the denture. They calculated the vertical load exerted on a premature contact on occlusal facets, three different loading facets used [3].

Abdalbasit A. F., used three dimensional finite element stress analysis method to assess the stress distribution and displacements in a lower complete denture, the samples consist of two parts; depend on occlusal plane leveled as follow with the upper, middle and lower third of the reto molar pad (RMP) to study the effect of balanced, ligualized, and monoplane occlusion concepts on the stress distribution and displacements. The load used was (58.8 N) directed axially applied on specific sites. The results show that both linguialized and balanced occlusion exert minimal stresses and rotational movements when level with the middle third of RMP and when occlusal surface of teeth become closest to the ridge crest more incidence of rotational movements occur, while for improved monoplane occlusion stability over the three occlusal plane with no rotational movement [4].

Al-Huwaizi A. F., evaluated the effect of retention holes and other retention means on the stress distribution at the denture tooth/denture resin interface, in an attempt to increase the retention force of the tooth on impact. A two-dimensional plain strain finite element model was designed to simulate the anterior portion of the complete denture. Different designs of grooves were made on the tooth ridge lap and examined by the Ansys program for the stress distribution. Results of the model with triangular grooves and the model with three grooves showed the best stress distribution along the resin tooth/denture resin interface. Conclusion putting small multiple grooves along the tooth ridge lap showed to be beneficial in distribution of the forces along the ridge lap [5].

Ricardo V. A. et. al., used finite element analysis was performed by Ansys program to compare stress distribution on complete dentures and implant-retained over dentures with different attachment systems, with (100 N) vertical load applied on central incisive teeth. Four models of edentulous mandible were constructed: group A as control complete denture; group B, over denture retained by 2 splinted implants with bar-clip system; group C, over denture retained by 2 unsplinted implants with o'ring system; and group D, over denture retained by 2 splinted implants with bar-clip and 2 distally placed o'ring system. The lowest maximum general stress value (in mega pascal) was observed in group A (64.305) followed by groups C (119.006), D (258.650), and B (349.873). Un splinted implants associated with o'ring system showed the lowest maximum stress values among over all denture groups. And o'ring system improved stress distribution when associated with bar-clip system [6].

Cheng et. al., study was conducted to evaluated strain distribution in dentures during application of occlusal load with three dimensional (3-D) finite element analyses (F.E.A). Maxillary complete denture was converted into a (3-D) numerical model. The posterior teeth were loaded with an occlusal force of (230 N), and the basal bone was constrained for performing F.E.A. The results revealed that the highest tensile and compressive strains were found at the incisal and labial frenal notches, respectively. The high tensile strain concentration at the incisal notch is to cause of denture fracture during clinical service [7].

Chladek et. al., studying the F.E.M analysis of large displacements was used for calculation of the contact stresses beneath a lower denture that accompany destabilization under the realistic oblique mastication forces and stabilization of a non-working flange at the balancing contacts. The pressure on the surface of a mucous membrane beneath a denture that was loaded in a stable manner with a vertical occlusal force of (100 N) was lower than the pain threshold [8].

In this work, the theoretical study calculating the (Poisson's ratio and theoretical safety factor) as input and output data of the numerical part, while the numerical analysis of this denture by using finite element method (FEM) to confirm the experimental results, which are performing by using program (ANSYS-15) workbench to study (equivalent Von Miss stresses, maximum total deformation and equivalent elastic strain) of the upper composite prosthetic complete denture that manufactured from different materials used in experimental part. And definitions of dangerous region in the upper prosthetic complete denture.

Experimental Work

The tensile test is performed according to (ASTM D638-03) by using tensile machine (universal testing machine), type (Instron) at a cross head speed of (5mm/min) and load was applied equal to (5 kN) until break the specimen occur. As recommended by (ADA Specification No.12, 1999). All these tests carried out in air at room temperature (23 ± 2) °C after complete finishing and polishing processes, and immersion the specimens in distilled water at (37 ± 1) °C for (48 hr), in order to remove any residual monomer and release residual stress, also to ensure that the denture base materials remains in semi oral environment. Five specimens where used for most tests and final results represent the average for five specimens it was tested, the results of the tensile test as shown in Table (1) for PMMA composite and hybrid lamination composite specimens, that are prepared in this study. Figure (1) shows the standard specimen of tensile test [9 and 10].

Analysis of Denture

The analysis of denture problem requires an accurate modeling and meshing that achieve reasonable accuracy in the results. The accuracy is very sensitive to variation of all specified characteristics (material properties, geometry, lamina details, loads and boundary conditions, analysis steps, etc.)

Finite Element (F.E.) model of the prosthesis denture was created to determine the effect of parameters variations on the static and dynamic loads of prosthesis denture.

The analysis of composite material denture to studied different characteristics and behavior under static loads by creating numerical simulation models for different properties such as stresses, strains, deformation and safety factor by using the (ANSYS-15) program, also F.E. models of the prosthesis denture were built according to the standard specifications of tests.

In order to simplify the problem, the mechanical properties have been assumed of denture quasi-isotropic and linearly elastic medium in the analysis of the F.E.M. The F.E.M can be used in dentistry field in many applications including fixed (partial and complete) denture, removable (partial and complete) denture, in implantology and in dental materials [11].

By assembling the element stiffness matrices and the corresponding load vectors, a system of algebraic equation can be obtained in the following equation:

$$[K]\{\phi\} = \{f\} \quad \dots(1)$$

Where:

[K] = is the global characteristic matrix (element stiffness matrix).

{f} = is the global load vector.

{ ϕ } = is the global field variable vector.

The procedure of assembly is based on the requirement of compatibility and equilibrium at the element nodes. Generally, the assembly process is carried out by adding the terms of the element matrix and load vector to their corresponding positions in the global characteristic matrix [K]. The corresponding position in the global stiffness

matrix can be found by considering the local number of the nodes within the element and their global number in the system of the equations [12].

Analysis Procedure

Modeling

The most important point of the finite element analysis in order to analyze the load applied on the denture in order to obtain good fitting for the prosthetic denture.

In the (ANSYS) program, a model of three dimensions finite element of upper complete denture is built according to the true geometrical dimensions of the prosthetic denture. The prosthetic denture is not simple shape to model with finite element modeling due to its unique geometry without simplification of the shape.

The dimensions of the denture were measured by using Cartesian coordinates. By using AutoCAD software program, the upper complete denture was plotted by measuring and recording its (x, y, z) dimensions. The measurement is done for every ten degrees at each level. This is accurate enough due to small changes in the angle between measured points and the average thickness of specimens is entered as (4 mm) [13]. Finally, exported the upper complete denture geometry to (ANSYS-15) workbench was produced as shown in Figure (2).

Element Type Selection

The element type chosen in this study is (SOLID -185) as shown in Figure (3) is used for 3-dimension modeling of solid structures. It is defined (provided) by eight nodes having six degrees of freedom at each node include (UX, UY, UZ) translation in the nodal x, y and z axes and rotations about the x, y and z axes.

The element has any special orientation and it has special features of plasticity, hyper elasticity, stress, stiffening, creep, large deflection, and large strain capabilities.

The (SOLID -185) structural solid is suitable for modeling, and it is identical of denture structure in this model. Also it allows for prism and tetrahedral degenerations when used in irregular regions and tolerates irregular shapes without many losses in accuracy [14].

Material Properties

Most element types require material properties depending on the application of these materials. Here the materials were assumed quasi-isotropic homogeneous and linear elastic.

The mechanical properties (tensile strength and young's modulus) of the composite material that were used in this study were determined experimentally from the tensile test. But Poisson's ratio was calculated theoretically from rule of mixture to give engineering constant for denture composite material by applied equation (2). Table (1) contains only one value of modulus of elasticity and Poisson's ratio properties, that using in the (ANSYS-15) program for the teeth and composite prosthetic denture base materials that prepared in this study [15].

$$v_c = \sum v_i V_i \quad \dots(2)$$

Where:

ν_C : Poisson's ratio of composite materials .

U_i : Poisson's ratio of constituents composite material.

V_i : Volume fraction of constituents composite material.

Mesh Generation

The upper complete prosthetic denture as previously stated in a very complex composite structure, compared with simply supported beam of composite when load is applied on the middle span. For a structure as a prosthetic denture, it is necessary to divided into a sufficient number of elements in order to obtain a reasonable accurate result. On the other hand, the more elements that are used, the more costly will be analysis [16].

After the model geometry specification completed and material properties were defined, the next step in analysis provided a finite element mesh of the three dimensional element model's in order to obtain accurate results. The total numbers of element in the denture model were (9636), and the total numbers of nodes were (19631).

Boundary Conditions

In this step, the analysis type and options are definition; load is applied per unit length and displacement, finally begins the finite element solution [17].

The load applied on the complete denture equal (10%) from normal force in natural denture which equals to (90 Kg), therefore the constant load applied on complete prosthetic denture equal to (104 N).

The fixed supported of complete prosthetic denture on the stone cast from one side at x, y, and z axes, but remained free at z axes in other side. The occlusal load (biting force) applied on the specific sites that selected at the last four teeth of prosthetic denture as shown in Figure (4). The forces applied to each key point in this model as rectangular components (Fz) [18].

Obtaining the Results

Several ways are available to obtain the results from the (ANSYS-15) package program. The Von Mises failure theory was used here in the finite element analysis of composite prosthetic dentures to determine the equivalent stresses (Von Mises stresses) values at selected nodes of the finite element mesh, and comparing it to the experimental strength material's (yield strength or ultimate tensile strength) to define safety factor of this material. The Von Mises stresses can be calculated by using equation (3) and the equation of safety factor can be written according to Von Mises (Distortion Energy) failure theory and calculated from the following equation (4). In addition, the Von Mises failure theory was used to determine the equivalent elastic strain and total deformation distribution values [19 and 20].

$$\sigma_{vm} = \sqrt{\frac{(\sigma_x - \sigma_y)^2 + (\sigma_y - \sigma_z)^2 + (\sigma_z - \sigma_x)^2 + 6(\tau_{xy}^2 + \tau_{yz}^2 + \tau_{zx}^2)}{2}} \quad \dots(3)$$

Where:

σ_x = principal normal stress in x-direction.

σ_y = principal normal stress in y-direction.

σ_z = principal normal stress in z-direction.

τ_{xy} = shear stress in xy-plane.

τ_{yz} = shear stress in yz-plane.

τ_{zx} = shear stress in zx-plane.

$$n = \frac{\sigma_y (\sigma_u)}{\sigma_{vm}} \quad \dots (4)$$

It must be $\sigma_{vm} \leq \sigma_y$ (safe).

Numerical Results

The results that were obtained from finite element analysis for the PMMA composite dentures and hybrid laminated composite dentures are discussed here by using (ANSYS-15) program.

From Figure (5) shows the contours plot of total deformation distribution of PMMA matrix composite denture that is prepared in this study. It can be noticed from this Figure that the highest value of total deformation occurred in the pure PMMA specimen, which are equal to (0.0067536 mm).

On the other hand the Figure (6) shows the relationship between the volume fraction of (nHA and ZrO₂) particles in PMMA resin and total deformation of the specimens for the first and second groups. It can be noticed that the values of total deformation decreased with increasing the volume fraction of both types of particles for both groups. And the values of total deformation for second group composite specimens are lower than those of total deformation for first group composite specimens. These results coincide with the experimental results of this study.

From Figure (7) shows the relationship between the volume fraction of nHA particles in PMMA resin and total deformation of the specimens for the third and fifth groups. It can be shown that with find glass fiber or Kevlar fiber in PMMA matrix, the total deformation decreasing.

It can also be shown in this Figure the values of total deformation increased with increasing the volume fraction of nHA particles for both groups, and the values of total deformation for third group composite specimens are higher than those of total deformation for fifth group composite specimens. These results coincide with the experimental results of this study.

From Figure (8) shows the relationship between the volume fraction of ZrO₂ particles in PMMA resin and total deformation of the specimens for the fourth and sixth groups. It can be shown that the values of total deformation decreased with increasing the volume fraction of ZrO₂ particles for both groups, and the values of total deformation for sixth

group composite specimens are lower than those of total deformation for fourth group composite specimens. These results coincide with those of the experimental results.

From Figure (9) shows the contours plot of the equivalent stress (Von Mises stress) of PMMA matrix composite denture that is prepared in this study. It can be noticed from this Figure that the value of equivalent stress was (19.912 MPa) at the point of applied load on the tooth.

From Figure (10) shows the contours plot of equivalent elastic strain of PMMA matrix composite denture that is prepared in this study. It can be noticed from this Figure that the value of equivalent elastic strain was (0.00925) at the point of applied load on the tooth.

The safety factor of the composites materials are obtained according to Von Mises Failure Theory. From Figure (11) shows the relationship between the volume fraction of (nHA and ZrO₂) particles in PMMA resin and theoretical safety factor of the specimens for the first and second groups.

It can also be noticed in Figure (12) shows the relationship between the volume fraction of nHA particles in PMMA resin and theoretical safety factor of the specimens for the third and fifth groups.

Furthermore, Figure (13) shows the relationship between the volume fraction of ZrO₂ particles in PMMA resin and theoretical safety factor of the specimens for the fourth and sixth groups.

From these Figures, it can be observed that all composites specimens are in safe side because it is the safety factor values are more than 1 which indicate that failure will not take place before the design life is reached [14].

Furthermore, it can be noticed that the highest value of safety factor occurred in the sixth group specimens when adding 5% Kevlar fiber and 3% ZrO₂ particles to PMMA resin, which is equal to (7.028). But the lowest value of safety factor can be seen in the pure PMMA specimen, which is equal to (2.611) as compared with the other composites specimens that are prepared in this study.

From Table (1) shows the values of (total deformation, Von Mises stress, elastic strain and safety factor) of the composite prosthetic dentures specimens at constant occlusal load (biting force) which equal to (104 N), that are prepared in this study.

Conclusion

This research involved numerical study by the tensile analysis of the prosthetic dentures made from composite material. According to the numerical results of this study, the following can be conclusions:

- 1- The highest value of total deformation was (0.0067536 mm) for pure PMMA specimen, while the lowest value was (0.0040059 mm) for PMMA reinforced by (5% Kevlar fiber and 3% ZrO₂ particles).
- 2- The value of equivalent stress (Von Mises stress) was (19.912 MPa) for PMMA composites prosthetic denture.
- 3- The value of equivalent elastic strain was (0.00925) for PMMA composites prosthetic denture.

4- The highest value of theoretical safety factor was (7.028) for PMMA reinforced by (5% Kevlar fiber and 3% ZrO₂ particles), while the lowest value was (2.611) for pure PMMA specimen.

5- The numerical results of the F.E.A showed coincided with the some of the experimental results.

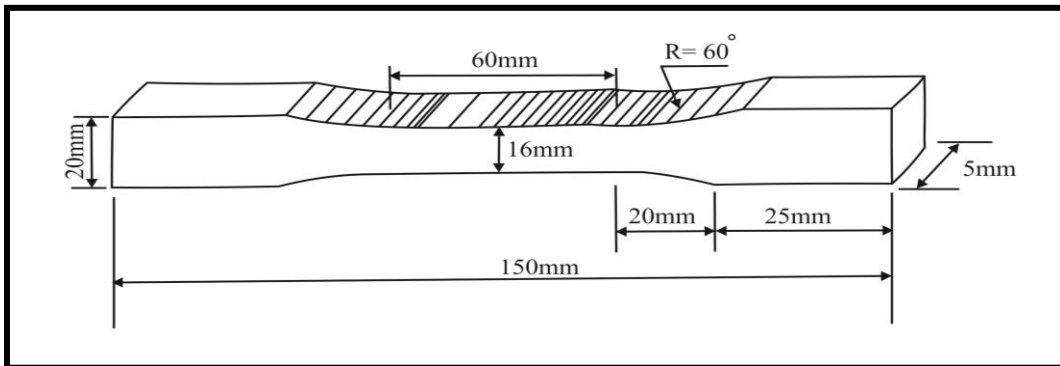

Figure (1): Schematic Specimen for Standard Specimen of Tensile Test [10].

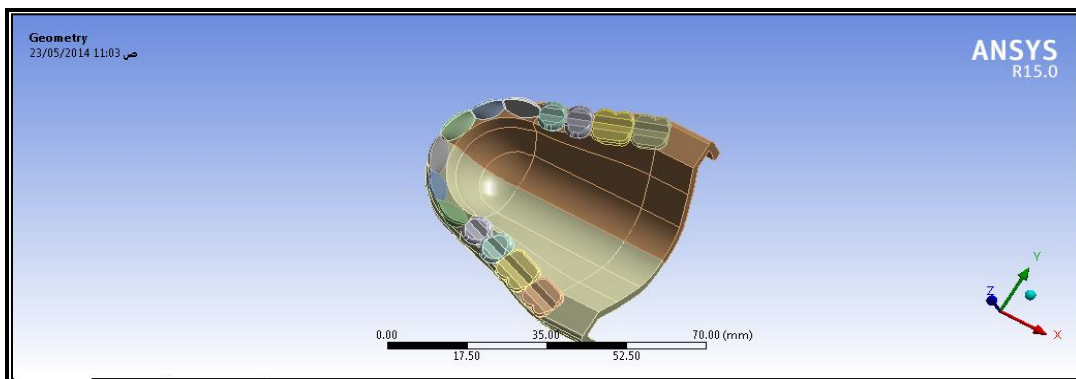

Figure (2): The (F.E.) Model of Complete Prosthetic Denture.

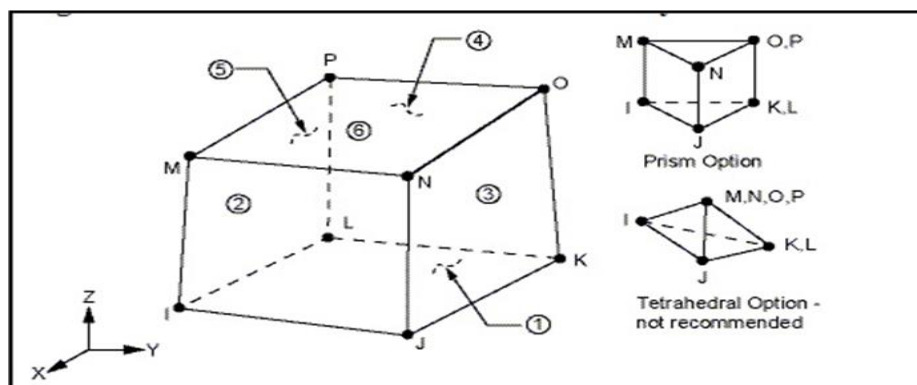

Figure (3): SOLID -185 [14].

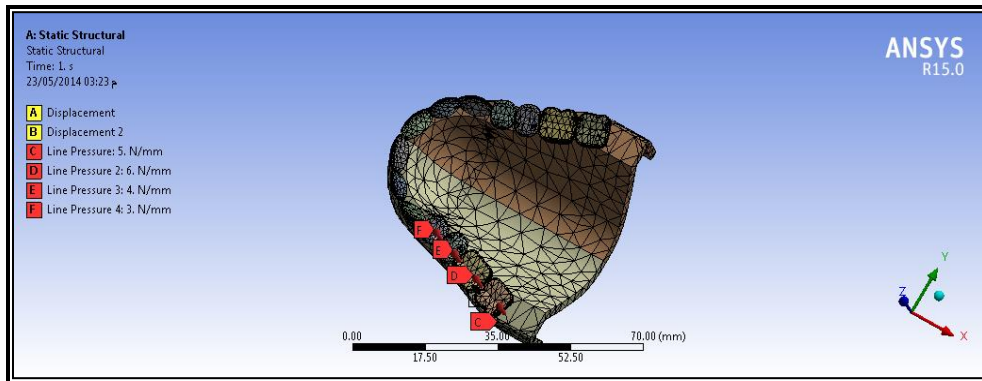

Figure (4): The Meshed Denture and Levels of Load Generated in Composite Prosthetic Denture during Mastication Process.

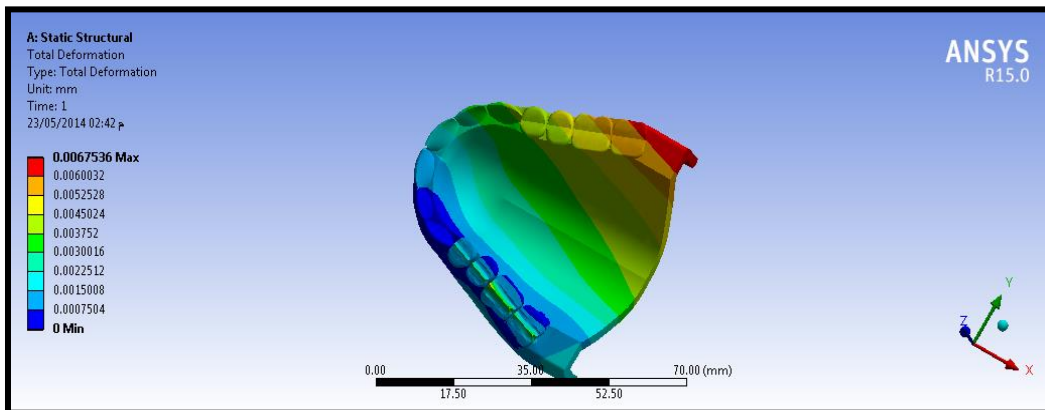

Figure (5): Contours of Total Deformation Distribution of PMMA Composite Dentures.

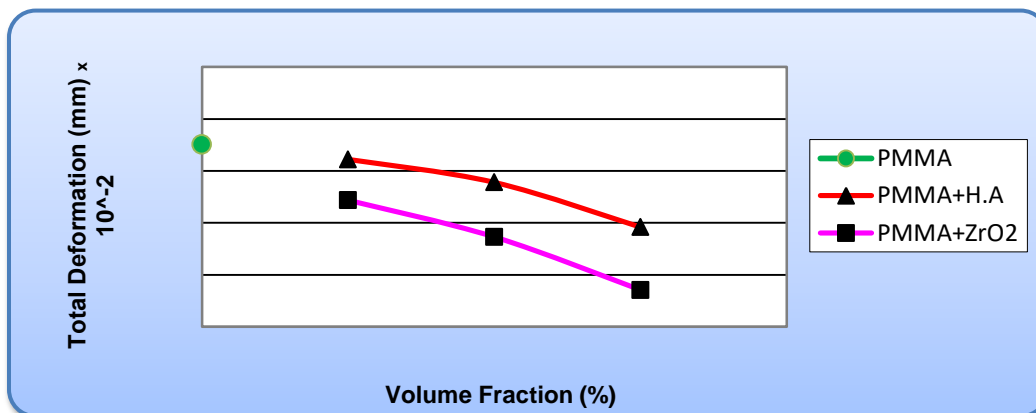

Figure (6): Total Deformation of PMMA Composite Materials as Function of (HA or ZrO₂) Particles (Vol %) in PMMA Composite.

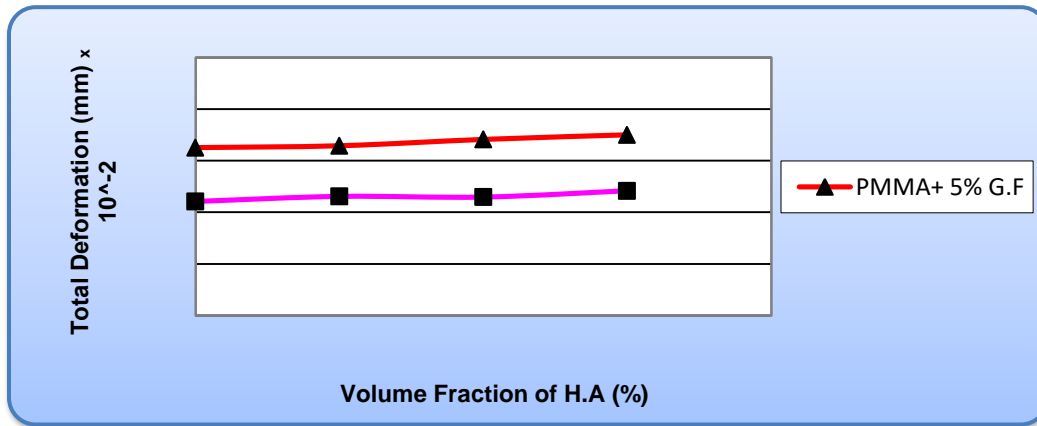

Figure (7): Total Deformation of Hybrid Laminated Composite Materials as Function of HA Particles (Vol %) in Composite and Type of Woven Fibers.

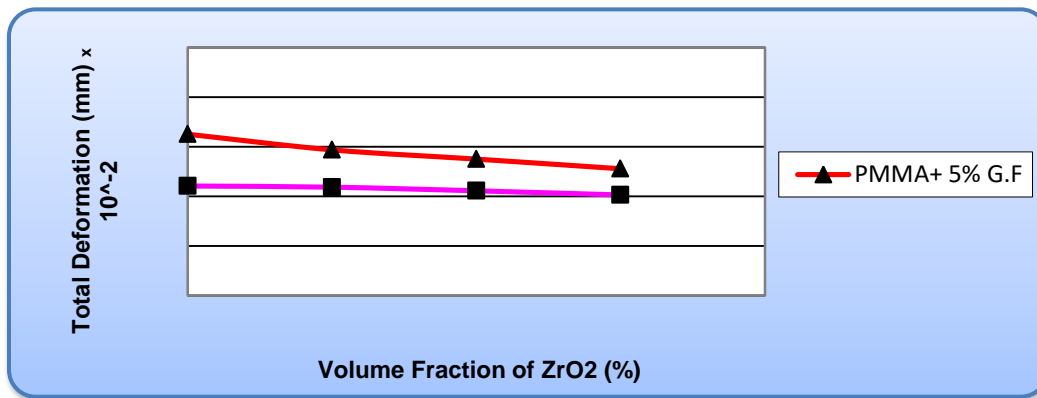

Figure (8): Total Deformation of Hybrid Laminated Composite Materials as Function of ZrO₂ Particles (Vol %) in Composite and Type of Woven Fibers.

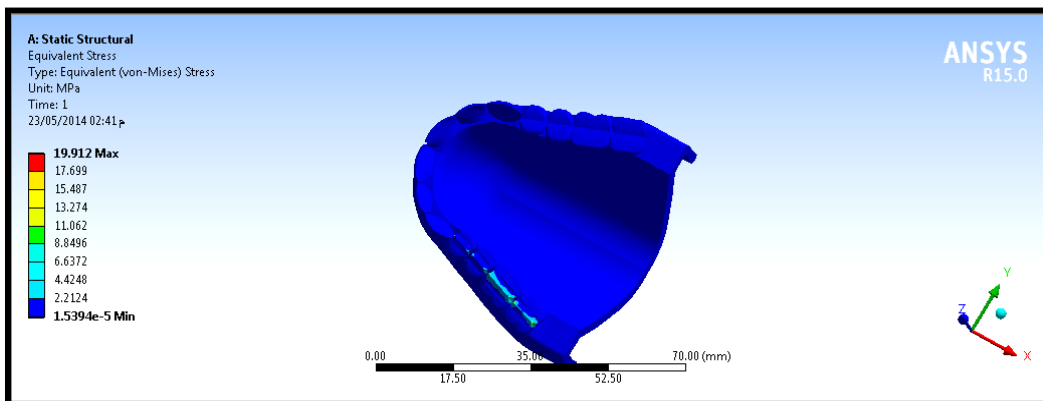

Figure (9): Contour of Equivalent (Von Mises) Stress of PMM Composite Denture.

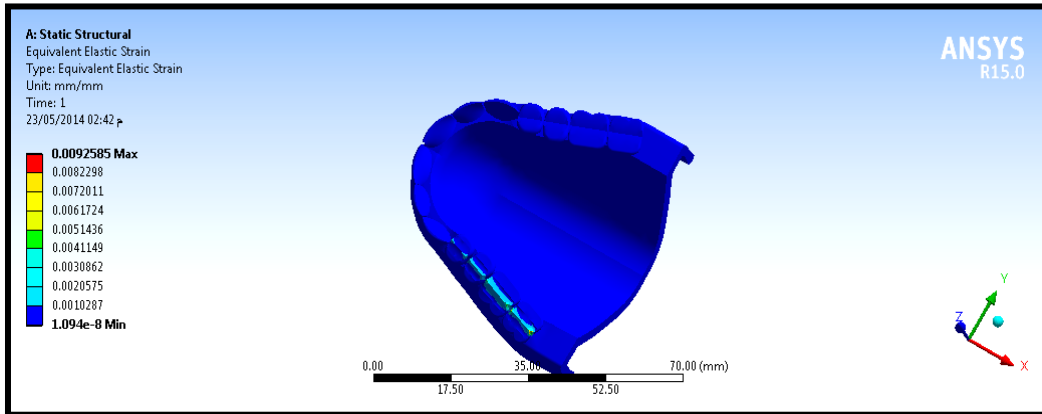

Figure (10): Contours of Equivalent Elastic Strain of PMMA Composite Denture.

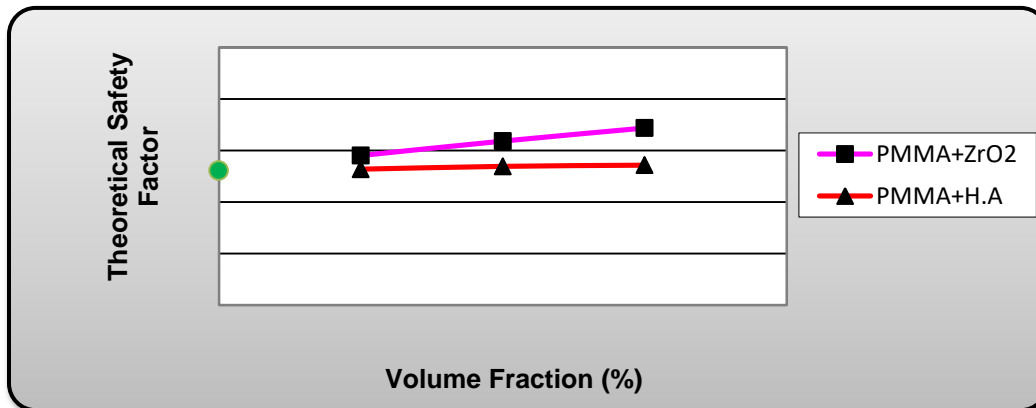

Figure (11): Theoretical Safety Factor of PMMA Composite Materials as Function of (HA or ZrO₂) Particles (Vol %) in Composite.

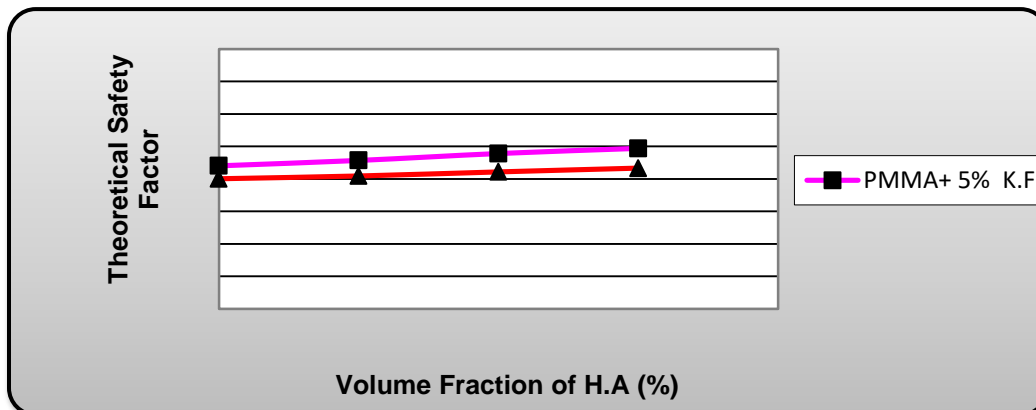

Figure (12): Theoretical Safety Factor of Hybrid Laminated Composite Materials as Function of HA Particles (Vol %) in Composite and Type of Woven Fibers.

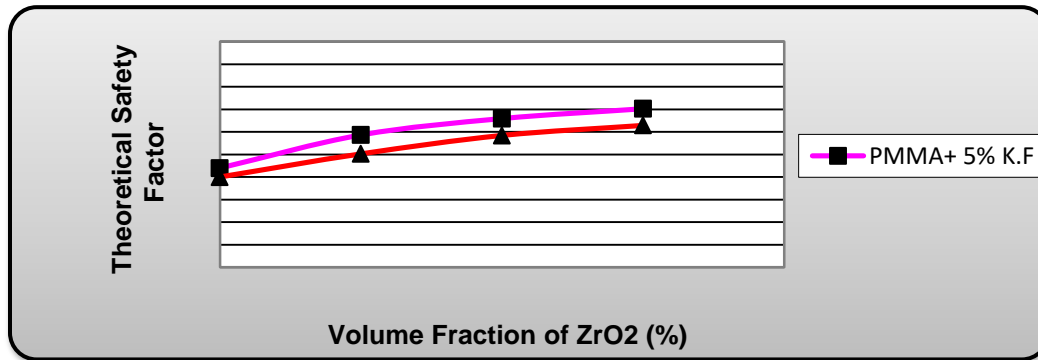

Figure (13): Theoretical Safety Factor of Hybrid Laminated Composite Materials as Function of ZrO₂ Particles (Vol %) in Composite and Type of Woven Fibers.

Table (1): Materials Properties and Numerical Results of Tensile Test for PMMA Composite and Hybrid Lamination Composite Dentures.

Lamination Composite Materials	Young's Modulus (GPa)	Poisson's Ratio	Tensile Strength (MPa)	Total Deformation (mm)	Von Mises Stress (MPa)	Elastic Strain (mm/m)	Safety Factor
Tooth [59]	2.65	0.35					
PMMA	1.65	0.4	52	0.0067536			2.611
PMMA + 1% nHA	1.698	0.3988	52.5	0.0066105			2.636
PMMA + 2% nHA	1.777	0.3976	53.6	0.0063893			2.691
PMMA + 3% nHA	1.951	0.3964	54.1	0.0059584			2.714
PMMA + 1% ZrO ₂	1.843	0.3991	57.8	0.0062174			2.901
PMMA + 2% ZrO ₂	1.993	0.3982	63.4	0.0058646			3.181
PMMA + 3% ZrO ₂	2.252	0.3973	68.5	0.0053541			3.435
PMMA + F.G	4.517	0.391	80	0.0042506			4.004
PMMA + F.G+ 1% nHA	4.469	0.3898	81.7	0.0042578			4.089
PMMA + F.G+ 2% nHA	4.287	0.3886	84.2	0.0042824			4.215
PMMA + F.G+ 3% nHA	4.168	0.3874	86.5	0.0043002	19.912	0.00925	4.331
PMMA + F.G+ 1% ZrO ₂	5.123	0.3901	100.5	0.0041877			5.029
PMMA + F.G+ 2% ZrO ₂	5.567	0.3892	116.8	0.0041505			5.845
PMMA + F.G+ 3% ZrO ₂	6.122	0.3883	125.7	0.0041115			6.29
PMMA + K.F	7.197	0.398	88	0.004042			4.401
PMMA + K.F + 1% nHA	6.825	0.3968	91.32	0.0040615			4.568
PMMA + K.F + 2% nHA	6.693	0.3956	95.56	0.0040588			4.78
PMMA + K.F + 3% nHA	6.462	0.3944	98.73	0.0040835			4.939
PMMA + K.F + 1% ZrO ₂	7.323	0.3971	117.3	0.0040373			5.867
PMMA + K.F + 2% ZrO ₂	7.678	0.3962	131.8	0.0040227			6.593
PMMA + K.F + 3% ZrO ₂	8.121	0.3953	140.5	0.0040059			7.028

References

- [1].Wachter W. "Innovatives Prothetik-System IvoBase - Marktanalyse Deutschland", Diplomarbeit, (2009).
1. Hamid N., "Two Dimensional FE Stress Analysis of Upper Complete Denture", M. Sc. Thesis, College of Dentistry, University of Baghdad, Iraq, (2000).
- [2].Takayama Y. et. al., "Dynamic Behavior of A lower Complete Denture during Unilateral Load Analysis Using FEM", Oral Rehabilitation Journal, Vol. (28), No. (11), PP. (1064-1074), (2001).
- [3].Abdalbasit. A. F., "Comparing Resultant Stresses and Displacements in A lower Complete Denture with Different Schemes and Levels of Occlusion. (A 3-D Finite Element Stress Analysis Study)", M. Sc. Thesis, College of Dentistry, University of Baghdad, Iraq, (2003).
- [4]. Abbas Faisal Al-Huwaizi, "Effect of Retention Grooves on Stress Distribution at the Resin Tooth/Denture Resin Interface (A finite Element Study) ", Journal of the College of Dentistry, Vol. (16), No. (11), PP. (7-10), (2004).
- [5]. Valentim Adelino Ricardo et. al., "Finite Element Analysis to Compare Complete Denture and Implant-Retained Overdentures with Different Attachment Systems", Journal of Craniofacial Surgery, Vol. (20), No. (4), PP. (1066-1071), (2009).
- [6].Yi. Y. Cheng et. al., "Strain Analysis of Maxillary Complete Denture with Three-Dimensional Finite Element Method", Journal Prosthetic Dental, Vol. (103), PP. (309-318), (2010).
- [7].Grzegorz Chladek et. al., "The Influence of A complete Lower Denture Destabilization on the Pressure of the Mucous Membrane Foundation", Acta. Of Bioengineering and Biomechanics, Vol. (14), No. (3), PP. (67-73), (2012).
- [8].Annual Book of ANSI/ADA Standard, "American National Standard/American Dental Association for Denture Base Polymers", Specification No. (12), PP. (1-14), (April, 1999).
- [9].Annual Book of ASTM Standard, "Standard Test Method for Tensile Properties of Plastics", D 638-03, PP. (1-12), (2003).
- [10].Abdalbasit. A. F., "Comparing Resultant Stresses and Displacements in A lower Complete Denture with Different Schemes and Levels of Occlusion. (A 3-D Finite Element Stress Analysis Study)", M. Sc. Thesis, College of Dentistry, University of Baghdad, Iraq, (2003).
- [12].Mohamad. K. A. et. al., "Tensile and Buckling Analysis of the Polymer Composite Beam Reinforced by Natural Jute Fiber", Eng. & Tech. Journal, Vol. (29), No. (1), PP. (129-140), (2011).
- [13].Display-IV User's Manual, "Engineering Mechanics Research Corporation", Version (10.5), Troy, Michigan, (Mar, 2001).
- [14]."(Ansys-15) Workbench Help Guide", SAS IP, Inc., 15th ed., (2014).
- [15].W. Bolten, "Engineering Materials Technology", 3rd ed., Butterworth & Heinemann publishing, Ltd., (1998).
- [16].Lawrence K. L., "Structure and Thermal Analysis Using the ANSYS Mechanical APDL Release 14 Environment", Schroff Development Materials Science and Engineering, Massachusetts Institute of Technology, Cambridge, (2012).

- [17]. Diane Higgs, Phanvan Sanders and Yesh P. Singh, "Design Specifications of Lower Limb Prosthesis Socket", Proceedings of the ASEE Gulf. Southwest Annual Conference, (2002).
- [18]. Jaroslaw et. al., "The Influence of a Complete Lower Denture Destabilization on the Pressure of the Mucous Membrane Foundation", Journal of Bioengineering and Biomechanics, Vol. (14), No. (3), PP. (67-73), (2012).
- [19]. Gong Tao and Zihui Xia, "Biaxial Fatigue Behavior of an Epoxy Polymer with Mean Stress Effect", International Journal of Fatigue, Vol. (31), PP. (678-685), (2009).
- [20]. Jawad K. O. et. al., "Numerically and Experimentally Studying of Some Mechanical Properties of the Polyester Matrix Composite Material Reinforced by Jute Fibers", Eng. & Tech. Journal, Vol. (32), Part (A), No. (9), PP. (2235-2247), (2014).