

Utilization of Multiple Access Communication System Based on Orthogonal Lu Chaotic Vector

Dr. Hikmat N. Abdullah 

Engineering College, University of Al-Mustansiryah/Baghdad
Email: dr.h.abdullah@ieee.com

Received on: 20/1/2014 & Accepted on : 6/11/2014

ABSTRACT:

The multiple access techniques based on chaotic signals suffer from high co-channel interference due to pseudo-orthogonal nature of chaotic signals. In this paper, an efficient chaotic multiple access communication system based on Orthogonal Chaotic Vector (OCV) generated from Lu system has been proposed. To measure the effectiveness of the proposed system, its performance has been compared with code division multiple access system (CDMA) based on Walsh-Hadamard sequence which has perfect orthogonality. The simulation results showed that the proposed scheme successfully separate the messages of each user and its performance is almost the same regardless of the number of users in AWGN channel. Furthermore, the results also showed that for four users and at bit-error-rate of 10^{-3} , the proposed system has achieved gains of 5 dB and 8 dB in signal-to-noise ratio over traditional CDMA system in AWGN and Rayleigh fading channels respectively. The simulation results obtained have confirmed the theoretical analysis derived for the proposed system.

Keywords: Chaotic signals, Multiple access, Lu system, orthogonal chaotic

تحقيق نظام اتصالات الوصول المتعدد اعتمادا على المتجه الفوضوي المتعامد نوع لوو

الخلاصة:

ان منظومات اتصالات الوصول المتعدد والتي تستخدم الاشارات الفوضوية تعاني من مشكلة التداخل البيئي بين القنوات بسبب الطبيعة الشبه متعامدة لهذه الاشارات. في هذا البحث تم اقتراح نظام وصول متعدد يركز على طريقة كفاءة لتوليد اشارات فوضوية ذات خواص تعامد ممتازة باستخدام متجه فوضوي متعامد (OCV) متولد من نظام لوو. ولقياس كفاءة النظام المقترح تم مقارنة اداءه مع نظام اتصالات الوصول المتعدد بالمتسلسلة المباشرة (CDMA) والذي يستخدم سلسلة والش-هامارد. لقد بينت نتائج المحاكاة بأن اداء النظام المقترح يمتلك اداء ثابت في قناة كاوس الضوضائية بغض النظر عن عدد المستخدمين. كما ان النظام المقترح ولاربعة مستخدمين يمكن ان يحقق تحسيفي نسبة الاشارة الى الضوضاء بمقدار 5 dB و 8 dB في قناتي كاوس الضوضائية و رايلي التوهينية على التوالي عند نسبة خطأ مقدارها 10^{-3} مقارنة بنظام الوصول المتعدد بالمتسلسلة المباشرة والمستند على سلسلة والش-هامارد. لقد أكدت النتائج التي تم الحصول عليها دقة وكفاءة النظام المقترح.

INTRODUCTION

Many recent researches have shown the effectiveness of applying chaotic sequences in multiple access digital communication systems to replace the pseudo-orthogonal binary code sequences [1-6]. For CDMA systems, sequences with low cross-correlation properties are required. Such sequences can be generated using chaotic systems with different initial conditions. The first proposal for possible use of chaotic sequences in multiple access systems is presented in [7], followed by some other similar proposals [8-11]. The performance of the chaotic CDMA system has been analyzed by Mazzini et al. [12]. They showed that chaos-based sequences can outperform m-sequences & Gold codes. Some researchers like Tse [13] warned that annotating engineering solutions with chaos terminologies may divert reviewers' attention away from comparing with conventional methods. Also researchers tend to present themselves very positively in talking about chaos. Thus potential advantages of chaotic solutions are emphasized, but difficult problems are often not discussed adequately. In case of CDMA systems, the current conventional spreading codes used in the 3G systems are the orthogonal Walsh codes. For such systems, it has been recognized (although generally not published) that the chaotic codes cannot beat the orthogonal codes in AWGN environment. However, because of the rather bad autocorrelation properties of the orthogonal codes, there should be cases in multipath channel environment, in which chaotic codes outperform orthogonal codes.

Orthogonal Chaotic Vector (OCV) [14] is an efficient way to generate orthogonal chaotic sequence that has good auto-correlation properties beside the good cross-correlation properties. Unfortunately, publications on the performance comparison of chaotic multiple access based on OCV with traditional CDMA based on orthogonal spreading codes are rare. Probably because it is commonly recognized that orthogonal spreading codes will generally outperform chaos map spreading codes. Furthermore, the little existing works considered the use of chaotic maps for multiple access although the chaotic flows like Lu are easier to be generated practically from physical electronic circuit. In this work, multiple access communication system based on the OCV of Lu flow sequences has been proposed and simulated. A random time-invariant multipath channel is used for BER simulations. The receiver is a rake receiver with enough fingers to capture all the energy from the multipath. Perfect channel estimation is assumed, and only downlink multiuser cases are simulated.

The rest of the paper is organized as follows: Section 2 describes the architecture of the proposed system. Section 3 presents the Lu system and OCV generation. The performance of the proposed system over AWGN and fading channels are given in sections 4 and 5 respectively. Finally, the simulation results and conclusions are presented in sections 6 and 7 respectively.

The proposed system structure

The block diagram of the proposed multiple access system based on Lu OCV system is shown in Figure 1. In the transmitter, for each one of the N_u users the data are generated using the random integer generator and then modulated using BPSK modulator. The modulated data of each user are spread using unique Lu chaotic sequence. The Lu sequences are generated by entering one of the outputs of Lu system (i.e. x-sequence, y-sequence, or z-sequence) to OCV circuitry to generate n orthogonal Lu sequences for N_u different users as shown in Figure 3 which will

explained later. The spreading operation is simply a multiplication process between the chaotic sequence and the BPSK modulated signal. The spread signals are added to each other and sent through the transmission channel. At the receiver, each of the N_u received signals wide-spread by multiplying it by the same chaotic signal replica used at the transmitter of the corresponding user. The energy produced by despread signal is detected by an integrate and dump operation followed by a threshold. Finally the recovered signal is demodulated to obtain the transmitted data.

The main difference between the proposed system and the traditional CDMA system used for wireless applications is that the digital Walsh-Hadamard sequence is replaced by Lu OCV analogue sequence to improve the system performance and capacity.

Lu orthogonal chaotic vector

The Lu system is a continuous-time dynamical system which belongs to the autonomous type of dynamical systems. The Lu system is three-dimensional system described by the following differential equations [15]:

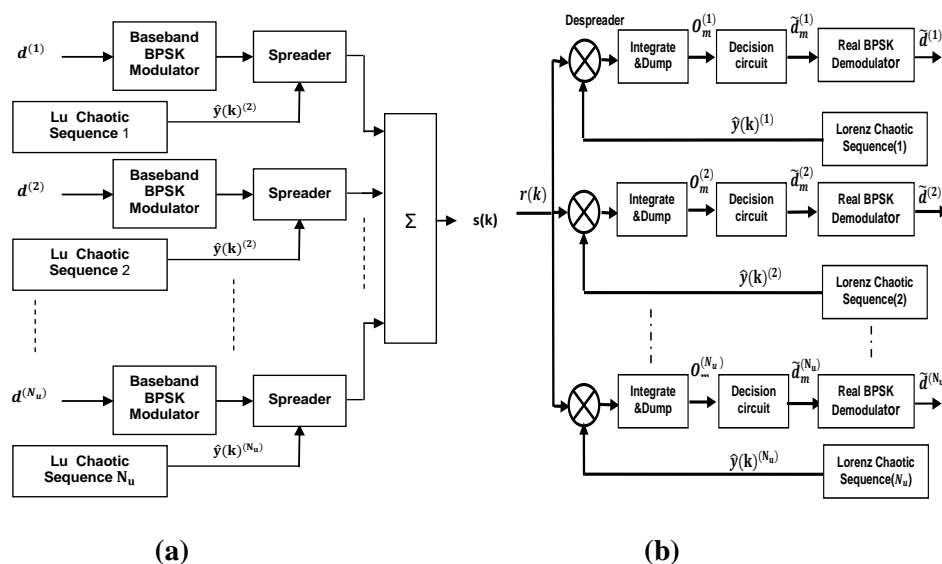

Figure (1):The proposed chaotic multiple access system based on Lu model. (a) the transmitter, (b) the receiver.

$$\dot{x} = a(y - x) \quad \dots (1)$$

$$\dot{y} = -xz + cy \quad \dots (2)$$

$$\dot{z} = xy - bz \quad \dots (3)$$

Where

[x y z] is the output state vector while a, b and c are three real valued parameters. As a three-dimensional system with three parameters, the Lu system can lead to very complicated behavior on changing the parameter values. Choosing the standard parameter values a = 36, b = 3, and c = 20, the attractor is obtained, as shown in Figure (2).

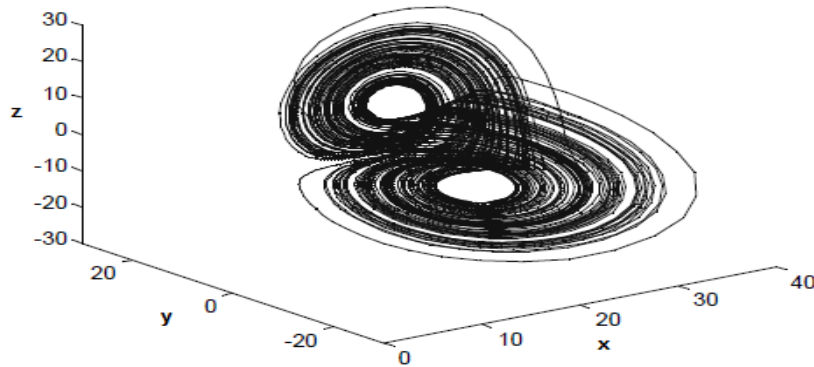

Figure (2): Lu attractor with parameters values: a = 36, b= 3, and c = 20.

The non-zero values of cross-correlation between mutual chaotic sequences (x, y, and z) of Lu system in chaotic multiple access system result in Multiple Access Interference (MAI) between users. The effect of MAI is increased as the number of users is increased. The effect of MAI problem can be eliminated by applying Gram-Schmidt's or tho-normalization process [16] on flow chaotic sequence vectors to obtain flow OCVs (x, y and z) respectively. Gram-Schmidt or tho-normalization process for N_u orthogonal chaotic signal generators is given by:

$$\hat{x}(k)^{(p)} = \frac{x(k)^{(p)} - \sum_{q=1}^{p-1} [\sum_{k=1}^{\beta} x(k)^{(p)} \hat{x}(k)^{(q)}] \hat{x}(k)^{(q)}}{\sqrt{\sum_{k=1}^{\beta} [x(k)^{(p)} - \sum_{q=1}^{p-1} [\sum_{k=1}^{\beta} x(k)^{(p)} \hat{x}(k)^{(q)}] \hat{x}(k)^{(q)}]^2}} \quad \dots (4)$$

Where

$p = 2, 3, \dots N_u$.
For $p = 1$ (i.e. single user)

$$\hat{x}(k)^{(1)} = \frac{x(k)^{(1)}}{\sqrt{\sum_{k=1}^{\beta} [x(k)^{(1)}]^2}} \quad \dots (5)$$

where $x(k)^{(j)}$ is the chaotic carrier for j^{th} user and β is the number of chaotic samples used to transmit single binary bit (i.e. spreading factor). These OCVs are used as spreader to spread message bits and to increase the numbers of active users. The OCV sequences can be generated from different outputs of Lu chaotic system (x, y, and z) with similar or different initial conditions. Figure 3 shows the OCV sequences generated using the output y of Lu system.

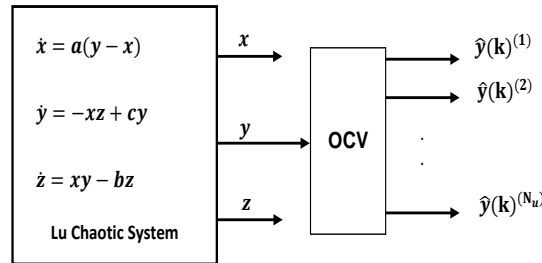

Figure (3): Generation of orthogonal chaotic sequences from Lu system

The mean value of chaotic carrier is made equal to zero in order to avoid unwanted dc power transmission. As it was mentioned in section 2, the chaotic sequences are multiplied by baseband modulated BPSK data sequence $d^{(j)} \{-1, +1\}$ to obtain the spread vector $v(k)^{(j)}$. The transmitted signals $s(k)$ is the sum of modulated OCVs of each user and can be represented as [14]:

$$s(k) = \sum_{i=1}^{N_u} v(k)^{(j)} \quad \dots (6)$$

Performance analysis over AWGN channel

Assuming that the signal is corrupted only due to AWGN, the received signal $r(k)$ can be represented as [11]:

$$r(k) = \sum_{i=1}^{N_u} V(k)^{(i)} + n(k) \quad \dots (7)$$

Where n

(k) is the additive white Gaussian noise with zero mean and $N_o/2$ variance. At the receiver, it is assumed that a similar replica of spreading sequence is available and it is exactly synchronized with the transmitted one. The m^{th} decoded symbol for the j^{th} user, denoted by $\tilde{d}_m^{(j)}$, is determined according to the rule:

$$\tilde{d}_m^{(j)} = \begin{cases} +1, & \text{if } O_m^{(j)} = \sum_{k=1}^{\beta} r(k) \hat{y}(k)^{(j)} > 0 \\ -1, & \text{if } O_m^{(j)} = \sum_{k=1}^{\beta} r(k) \hat{y}(k)^{(j)} \leq 0 \end{cases} \quad \dots (8)$$

without the loss of generality, we consider the probability of error for the first symbol. Omitting the subscripts of the variables $\tilde{d}_m^{(j)}$ and $O_m^{(j)}$ for the sake of brevity, the decision parameter of the j^{th} user is given by [14]:

$$O_m^{(j)} = d^{(j)} \sum_{k=1}^{\beta} [\hat{y}(k)^{(j)}]^2$$

$$+ d^{(j)} \sum_{i=1, i \neq j}^{N_u} \sum_{k=1}^{\beta} (\hat{y}(k)^{(i)} \hat{y}(k)^{(j)})^2 + \sum_{k=1}^{\beta} n(k) \hat{y}(k)^{(j)} \quad \dots (9)$$

Since chaotic vectors used for each user is ortho-normal to each other, the second term in equation (9) causing MAI will be equal to zero. Assuming, that $O_m^{(j)}$ has a Gaussian distribution, the BER for j^{th} user can be written as [14]:

$$BER^{(j)} = \frac{1}{2} \operatorname{erfc} \left(\sqrt{\frac{E_b}{N_o}} \right) \quad \dots (10)$$

From equation (13) it can be concluded that BER performance of the proposed system is independent on the number of users and spread factor which is a unique and strong feature does not exist in other traditional multiple access systems.

Performance analysis over Rayleigh fading channel

Assuming that the channel is a slow Rayleigh fading channel, let α is a Rayleigh distributed random variable denoting fading gain. Then it can be shown that the BER of j^{th} user in symbol duration is:

$$BER_{\alpha}^{(j)} = \frac{1}{2} \operatorname{erfc}(\gamma) \quad \dots (11)$$

Where

$$\gamma = \frac{\alpha E_b}{N_o} \quad \dots (12)$$

Since α is Rayleigh-distributed random variable, γ (the received instantaneous signal to noise ratio per bit) will be chi-square distributed and has the form [14],

$$f(\gamma) = \frac{1}{\bar{\gamma}} e^{-\frac{\gamma}{\bar{\gamma}}}, \gamma \geq 0 \quad \dots (13)$$

where,

$$\bar{\gamma} = E[\gamma] = E[\alpha] \cdot \frac{E_b}{N_o} \quad \dots (14)$$

Therefore

the average BER for j^{th} user is:

$$BER^{(j)} = \int_0^{\infty} BER_{\alpha}(\gamma) f(\gamma) d\gamma \quad \dots (15)$$

The last equation shows that in case of Rayleigh fading channel, there is no clear relation whether the BER performance of the proposed system is independent on the number of users and spread factor or not. Therefore, the simulation results may give us more clear view about this issue.

Simulation Results

A complete simulation model for the proposed OCV Lu based multiple access system shown in Figure 1 has implemented in MATLAB. Besides, another simulation model for traditional CDMA system based on orthogonal Walsh-Hadamard code with the same simulation parameters has also implemented for the purpose of performance comparison. In all simulation results the spreading factor is chosen to be 64 in both systems. The parameters of the generated Lu sequence were $a = 36$, $b = 3$, and $c = 20$ while the initial conditions were $[x_0 \ y_0 \ z_0] = [0.05-0.111 \ 0.09]$. The number of users has changed from single user to a maximum of 16 users.

Simulation results in AWGN channel:

Figure (4) shows the BER performances of the multiple access system based on OCVs generated from individual outputs of Lu system (x, y, and z) for single user transmission in AWGN channel together with traditional CDMA system. It can be noticed from this figure that the performances of OCVs generated using different outputs of Lu system is not the same. The OCV associated with output y has the best performance. It outperforms the traditional CDMA and the OCV associated with outputs x and z. For example, at $BER=10^{-3}$, a gain of 5 dB in E_b/N_0 is obtained over traditional CDMA while 0.5 dB and 1.5 dB are obtained over OCV associated with outputs x and z respectively. Therefore, the OCV associated with output y will be selected for all the remaining simulation results.

Figure (5) depicts the BER performances when the number of users is 4. Once again, the OCV based multiple access system outperforms the traditional CDMA. At $BER=10^{-3}$, a gain of 5 dB in E_b/N_0 is obtained. The improvement can be attributed to good combination of auto and cross-correlation properties of Lu OCVs. In other word, OCV sequences has ideal auto-correlation properties and acceptable cross-correlation ones while Walsh sequences has ideal cross-correlation properties but worse auto-correlation ones.

Figure (6) shows the performance of the proposed OCV of Lu based multiple access system with different number of users. It can be seen in this figure that the performance of the proposed system is almost the same even if the number of users is increased. This result confirms the conclusion mentioned early in section 4 upon the commenting on equation (10).

Simulation results in Rayleigh fading channel:

Figure (7) shows the BER performances of CDMA based on OCVs generated from individual outputs of Lu system (x, y, and z) for single user transmission in 3-tap random time-invariant Rayleigh multipath channel together with traditional CDMA system. It can be seen in this figure that all OCVs generated from different Lu system outperforms the traditional CDMA system. However, the best performance results are obtained in the case of (output y). However, the best performance results are obtained in the case of output y as it was the case in AWGN channel. At $BER=10^{-3}$, a gain of 5 dB in E_b/N_0 is obtained.

Figure (8) shows the BER performance comparison when the number of users is 4. Here, it can be easily noticed that the OCV Lu based on CDMA outperforms the traditional CDMA. Once again, the improvement in the case Rayleigh fading channel is more than AWGN case. For instant, at $BER=10^{-3}$, a gain of 8 dB in E_b/N_0 is obtained in Rayleigh fading channel while it was 5 dB in AWGN channel. Finally, Figure 9 depicts the performance of the proposed OCV of Lu based CDMA system with different number .

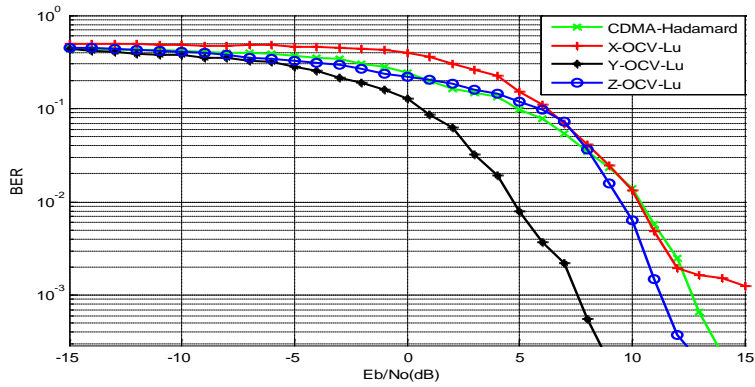

Figure(4): Performance of Lu OCV sequences and Hadamard sequence for single user transmission in AWGN channel

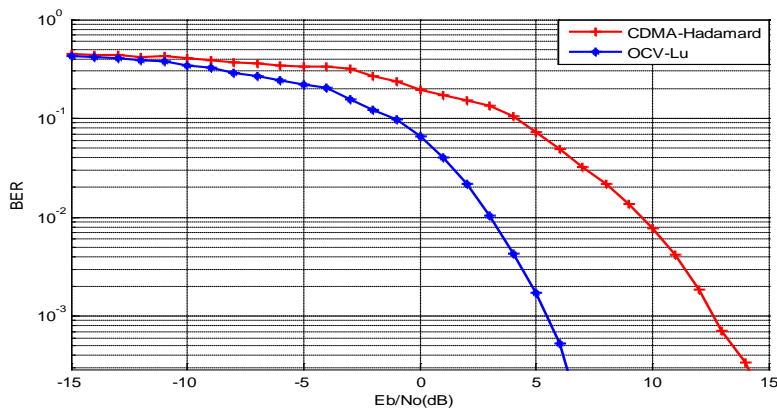

Figure (5): Performance of Lu OCV (sequence y) and traditional CDMA for 4 users transmission in AWGN channel

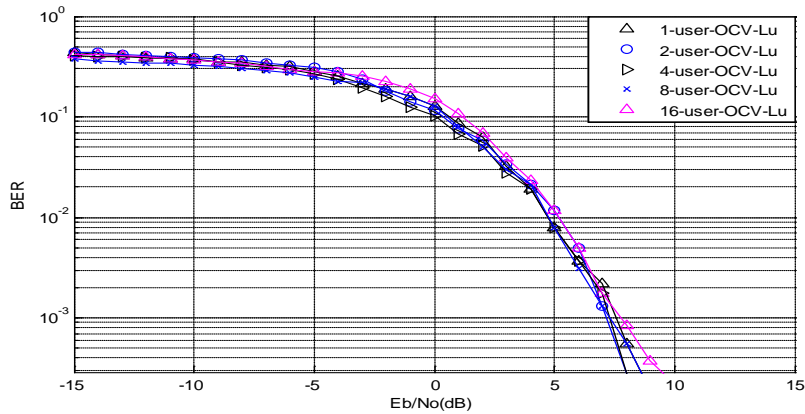

Figure (6): Performance of Lu OCV for different number of users in AWGN channel.

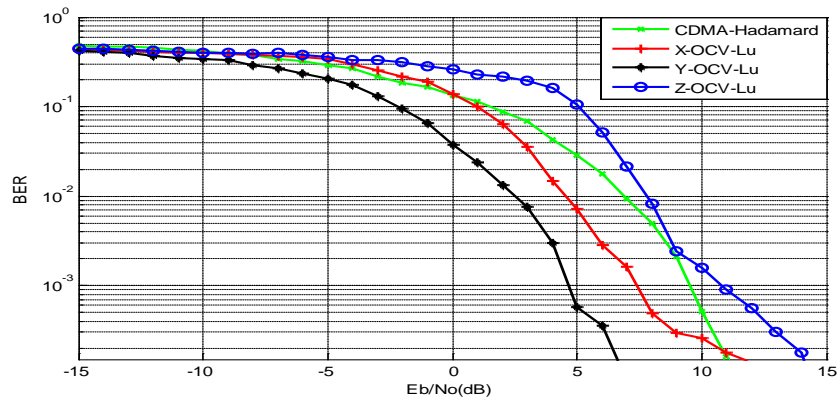

Figure (7): Performance of Lu OCV sequences and the Hadamard sequence for single user transmission in Rayleigh fading channel.

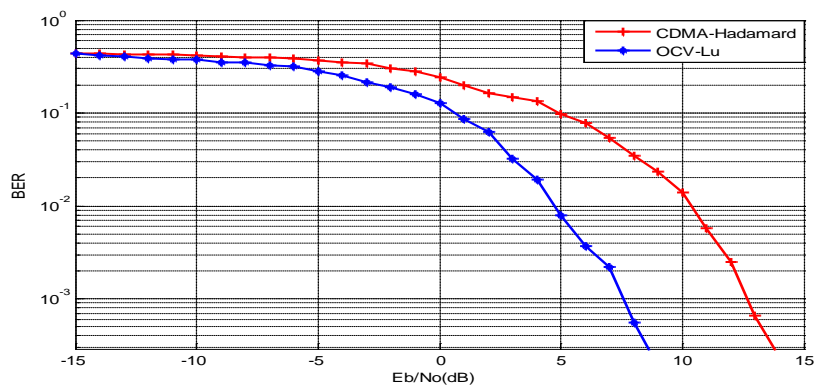

Figure (8): Performance of Lu OCV (sequence y) and traditional CDMA for 4 users transmission in Rayleigh fading channel

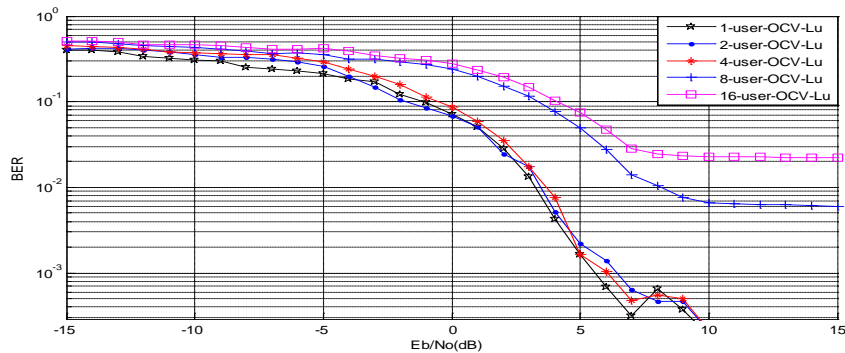

Figure (9): Performance of Lu OCV for different number of users in Rayleigh fading channel

of users. In contrast to AWGN channel, the performance of the proposed system in Rayleigh fading channel is dependent on the number of users used where it is improved as the number of users is decreased. However, this performance is better than the traditional CDMA for the similar number of users used.

Overall and according to the performance curves in both AWGN and Rayleigh fading channel, the proposed system offers the following features: first, many sets of OCV vectors can be generated for each of Lu chaotic system output. The selection of a certain output can be optimized according to selection of suitable initial conditions. Second, the proposed system offers gain in SNR over the traditional CDMA system in AWGN channel: 5 dB for both single user and four users cases. Furthermore, it offers gain in SNR over the traditional CDMA system in Rayleigh fading channel: 8 dB for single user case and 5 dB for four users case. All gain values mentioned above are measured at $BER=10^{-3}$. Third, the proposed system has improved capacity as compared with traditional CDMA system since it has less sensitivity to the increase in the number of users.

CONCLUSIONS

The performance of multiple access system can be significantly improved by the use of OCV generated from Lu chaotic system using Gram-Schmidt orthonormalization process as a spreading sequence. OCV has ideal auto-correlation properties and acceptable cross-correlation ones. The combination of these features is the reason behind its good performance in both AWGN and fading channels as compared with the traditional Walsh-Hadamard sequence which has ideal cross-correlation properties but worse auto-correlation ones. OCVs generated from different Lu system outputs have different performances; so, the one of the best performance should be selected to obtain the best improvement.

Finally, as the theoretical analysis and simulation results showed, OCVs have almost the same performance regardless of the number of users or the spreading factor in AWGN channels which is a unique feature as compared with other multiple access techniques.

REFERENCES

- [1] B. Jovicic et al, "A robust sequence synchronization unit for multi-user DS-CDMA chaos based communication systems", *Journal of Signal Processing*, Vol. 87, No.7, 2007, pp. 1692-1708.
- [2] F.C. Lau et al, "A multiple access technique for differential chaos-shift keying", *IEEE Transactions on Circuits and Systems I: Fundamental Theory and Applications*, Vol. 49, 2002, pp. 96-104.
- [3] M. Coulon and D. Roviras, "Multi-user receivers for synchronous and asynchronous transmissions for chaos-based multiple-access systems", *Journal of Signal Processing*, Vol.89, 2009, pp. 583-598.
- [4] W.M.Tam et al, "A multiple access scheme for chaos-based digital communication systems utilizing transmitted reference", *IEEE Transactions on Circuits and Systems: Regular Papers*, Vol. 51, No. 9, 2004, pp. 1868 – 1878.
- [5] J. G. Lu, "Multiple access chaotic digital communication based on generalized synchronization Chaos", *IEEE Transactions on Circuits and Systems: Solitons & Fractals*, Vol. 25, No.1, 2005, pp. 221-227.
- [6] D. He and H. Leung, "Quasi-orthogonal chaotic CDMA multi-user detection using optimal chaos synchronization", *IEEE Transactions on Circuits and Systems II: Express Briefs*, Vol. 52, No. 11, 2005, pp. 739 – 743.
- [7] G. Heidari-Bateni and C.D. McGillem, "Chaotic sequences for spread spectrum: An alternative to PN-sequences," in *Proceedings of the IEEE International Conference on Selected Topics in Wireless Communications*, Vancouver, Canada, December 1992, pp. 437-440.
- [8] A. Abelet et al, "Chaotic codes for CDMA applications," *Proceedings of European Conference on Circuit and Design*, Budapest, Hungary, September 1997, Vol. 1, pp. 306-311.
- [9] J.M. Elmirghani and R.A. Cryan, "Point-to-point and multi-user communication based on chaotic sequences," in *Proceedings of IEEE International Conference on Communications*, Seattle, USA, June 1995, Vol. 1, pp. 582-584.
- [10] T. Kohda and A. Tsuneda, "Even- and odd-correlation functions of chaotic Chebyshev bit sequences for CDMA," in *Proceedings of the IEEE International conference on Spread Spectrum Techniques and Applications*, Oulu, Finland, July 1994, Vol. 2, pp. 391-395.
- [11] T. Yang and L.O. Chua, "Chaotic digital code division multiple access (CDMA) communications", *International Journal of Bifurcation and Chaos*, Vol.7, 1997, pp. 2789-2805.
- [12] G. Mazzini et al, "Chaos-based asynchronous DSSSS systems and enhanced RAKE receivers: Measuring the improvements," *IEEE Transactions on Circuits and Systems: Fundamental Theory and Applications*, Vol. 48, No. 12, December 2001, pp. 1445-1453.
- [13] C.K. Tse, "The chaos panacea," in *Proceedings of the IEEE International Conference on Industrial Technology*, December. 2005, pp. 7-10.
- [14] S. Venkatesh and P. Singh, "An Improved Multiple Access Chaotic Communication System Using Orthogonal Chaotic Vectors," *Proceedings of the first International Conference on Communication and Signal Processing ICCSP*, Rourkela, India, February 2011.
- [15] K. Kemih and M. Benslama, "Performance of Chaotic Lu System in CDMA Satellites Communications Systems," *International Journal of Information Technology*, Vol. 3. No. 3, 2006, pp. 186-193.
- [16] S. Haykin, "Communication Systems," 3rd Edition, John Wiley & Sons, 1994

